

***STANDARD  
SPECIFICATIONS  
for  
ROAD AND BRIDGE  
CONSTRUCTION***



***STATE OF NEW HAMPSHIRE  
DEPARTMENT OF TRANSPORTATION***

***March 2016***

APPROVED: *William Carr*  
CHIEF ENGINEER

*2/24/16*  
DATE



# ***PREFACE***

This edition of the Standard Specifications for Road and Bridge Construction, State of New Hampshire, Department of Transportation will be used for projects designed and bid in English units only.

Information which has been changed from the 2010 Standard Specifications is noted with vertical lines to show added or revised information and horizontal lines to show a deletion. These lines are located in the margin. The revision marks are intended to facilitate location of new material, but provide no guarantee, explicit or implicit, that text not highlighted has appeared in prior editions of the Standard Specifications.

Supplemental Specifications to the 2016 Standard Specifications will be posted on the New Hampshire Department of Transportation website as they become available.

Look in the Business Center at the [Department's Website](#) for the electronic PDF version of the NHDOT Standard Specifications and the Supplemental Specifications.



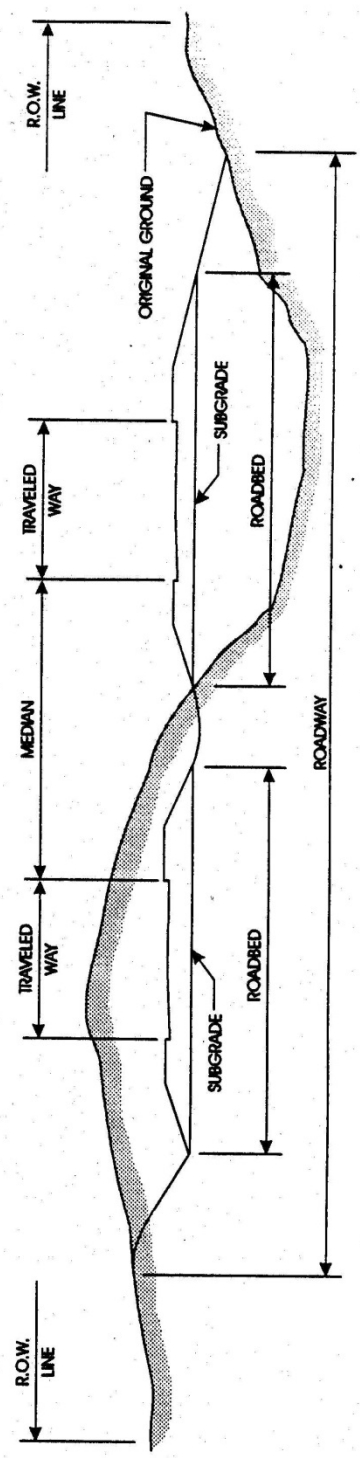
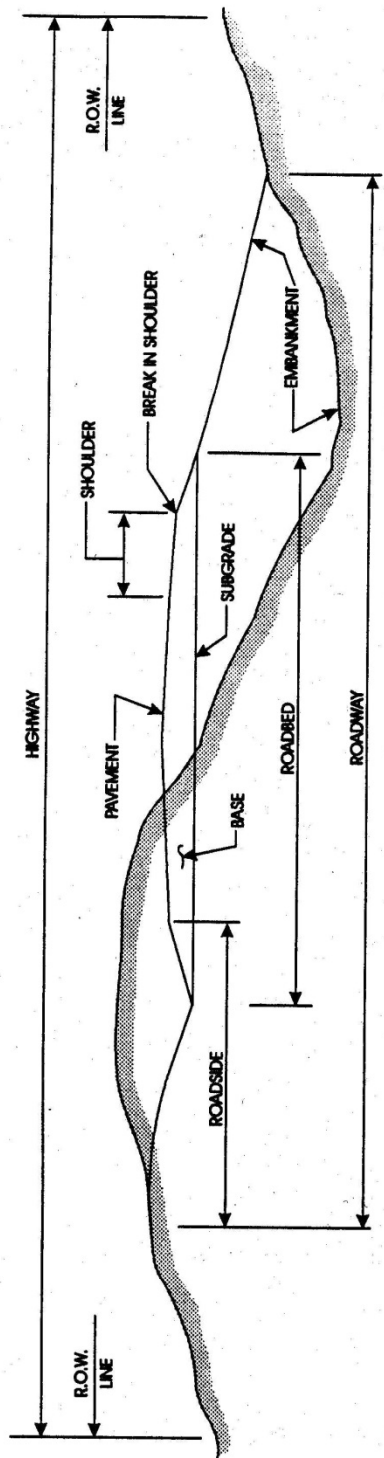

**ELEMENTS OF THE CROSS SECTION AS  
USED IN THESE SPECIFICATIONS**  
(SEE SECTION 101)



## **TABLE OF CONTENTS**

<b>DIVISION 1 00 -- GENERAL PROVISIONS</b>	<b>1-1</b>
SECTION 101 -- DEFINITIONS AND TERMS	1-1
SECTION 102 -- BIDDING REQUIREMENTS AND CONDITIONS	1-6
SECTION 103 -- AWARD AND EXECUTION OF CONTRACT	1-11
SECTION 104 -- SCOPE OF WORK	1-14
SECTION 105 -- CONTROL OF THE WORK	1-22
SECTION 106 -- CONTROL OF MATERIAL	1-32
SECTION 107 -- LEGAL RELATIONS AND RESPONSIBILITY TO PUBLIC	1-42
SECTION 108 -- PROSECUTION AND PROGRESS	1-51
SECTION 109 -- MEASUREMENT AND PAYMENT	1-61
<b>DIVISION 2 00 -- EARTHWORK</b>	<b>2-1</b>
SECTION 201 -- CLEARING AND GRUBBING	2-1
SECTION 202 -- REMOVAL OF STRUCTURES AND OBSTRUCTIONS	2-4
SECTION 203 -- EXCAVATION AND EMBANKMENT	2-8
SECTION 206 -- STRUCTURE EXCAVATION FOR PIPES AND OTHER MINOR STRUCTURES	2-25
SECTION 207 -- CHANNEL EXCAVATION	2-27
SECTION 209 -- GRANULAR BACKFILL	2-28
SECTION 211 -- VIBRATION MONITORING	2-29
SECTION 214 -- FINE GRADING	2-31
<b>DIVISION 3 00 -- BASE COURSES</b>	<b>3-1</b>
SECTION 304 -- AGGREGATE BASE COURSE	3-1
SECTION 306 -- RECLAIMED STABILIZED BASE	3-7
<b>DIVISION 4 00 -- PAVEMENTS</b>	<b>4-1</b>
SECTION 401 -- PLANT MIX PAVEMENTS -- GENERAL	4-1
SECTION 403 -- HOT BITUMINOUS PAVEMENT	4-30
SECTION 410 -- BITUMINOUS SURFACE TREATMENT	4-32
SECTION 411 -- PLANT MIX SURFACE TREATMENT	4-34
SECTION 413 -- HOT-POURED CRACK SEALANT	4-36
SECTION 417 -- COLD PLANING BITUMINOUS SURFACES	4-38
<b>DIVISION 5 00 -- STRUCTURES</b>	<b>5-1</b>
SECTION 501 -- TEMPORARY BRIDGE	5-1
SECTION 502 -- REMOVAL OF EXISTING BRIDGE STRUCTURE	5-3
SECTION 503 -- COFFERDAMS AND WATER DIVERSION STRUCTURES	5-4
SECTION 504 -- BRIDGE EXCAVATION	5-6
SECTION 506 -- SHEET PILING	5-9
SECTION 508 -- STRUCTURAL FILL	5-10
SECTION 510 -- BEARING PILES	5-12
SECTION 511 -- PREPARATION FOR CONCRETE BRIDGE DECK REPAIRS	5-22
SECTION 512 -- PREPARATION FOR CONCRETE REPAIRS	5-25

<i>SECTION 520 -- PORTLAND CEMENT CONCRETE</i>	5-26
<i>SECTION 528 -- PRESTRESSED CONCRETE MEMBERS</i>	5-60
<i>SECTION 530 -- WATERPROOFING CONCRETE SURFACES</i>	5-76
<i>SECTION 534 -- WATER REPELLENT</i>	5-77
<i>SECTION 536 -- EPOXY COATING FOR CONCRETE</i>	5-78
<i>SECTION 538 -- BARRIER MEMBRANE</i>	5-80
<i>SECTION 541 -- WATERSTOPS</i>	5-83
<i>SECTION 544 -- REINFORCEMENT FOR CONCRETE</i>	5-84
<i>SECTION 547 -- SHEAR CONNECTORS</i>	5-87
<i>SECTION 548 -- ELASTOMERIC BEARINGS</i>	5-91
<i>SECTION 550 -- STRUCTURAL STEEL</i>	5-92
<i>SECTION 556 -- PAINTING EXISTING STRUCTURAL STEEL</i>	5-124
<i>SECTION 559 -- ASPHALTIC PLUG EXPANSION JOINT,</i>	5-125
<i>SECTION 560 -- PREFABRICATED COMPRESSION SEAL EXPANSION JOINT</i>	5-129
<i>SECTION 561 -- PREFABRICATED EXPANSION JOINT</i>	5-132
<i>SECTION 562 -- SILICONE JOINT SEALANT</i>	5-137
<i>SECTION 563 -- BRIDGE RAIL</i>	5-138
<i>SECTION 565 -- BRIDGE APPROACH RAIL</i>	5-141
<i>SECTION 568 -- STRUCTURAL TIMBER</i>	5-142
<i>SECTION 570 -- STONE MASONRY</i>	5-145
<i>SECTION 572 -- STONE WALL</i>	5-148
<i>SECTION 582 -- SLOPE PAVING</i>	5-150
<i>SECTION 583 -- RIPRAP</i>	5-152
<i>SECTION 585 -- STONE FILL</i>	5-154
<i>SECTION 591 -- STRUCTURAL PLATE PIPES, PIPE-ARCHES, AND ARCHES</i>	5-156
<i>SECTION 593 -- GEOTEXTILE</i>	5-160

## **DIVISION 6 00 -- INCIDENTAL CONSTRUCTION**

**6-1**

<i>SECTION 603 -- CULVERTS AND STORM DRAINS</i>	6-1
<i>SECTION 604 -- CATCH BASINS, DROP INLETS, AND MANHOLES</i>	6-13
<i>SECTION 605 -- UNDERDRAINS</i>	6-18
<i>SECTION 606 -- GUARDRAIL</i>	6-21
<i>SECTION 607 -- FENCES</i>	6-32
<i>SECTION 608 -- SIDEWALKS</i>	6-36
<i>SECTION 609 -- CURBS</i>	6-39
<i>SECTION 614 -- ELECTRICAL CONDUIT</i>	6-43
<i>SECTION 615 -- TRAFFIC SIGNS</i>	6-47
<i>SECTION 616 -- TRAFFIC SIGNALS</i>	6-54
<i>SECTION 618 -- UNIFORMED OFFICERS AND FLAGGERS</i>	6-65
<i>SECTION 619 -- MAINTENANCE OF TRAFFIC</i>	6-68
<i>SECTION 621 -- DELINEATORS</i>	6-73
<i>SECTION 622 -- MARKERS AND BOUNDS</i>	6-75
<i>SECTION 624 -- RAILROAD PROTECTION</i>	6-77
<i>SECTION 625 -- LIGHT POLE BASES</i>	6-78
<i>SECTION 628 -- SAWED PAVEMENT</i>	6-79
<i>SECTION 632 -- RETROREFLECTIVE PAVEMENT MARKINGS</i>	6-80
<i>SECTION 641 -- LOAM</i>	6-87
<i>SECTION 642 -- LIMESTONE</i>	6-88
<i>SECTION 643 -- FERTILIZER FOR GRASSES</i>	6-89
<i>SECTION 644 -- GRASS SEED</i>	6-91



<i>SECTION 645 -- EROSION CONTROL</i>	6-95
<i>SECTION 646 -- TURF ESTABLISHMENT</i>	6-103
<i>SECTION 647 -- HUMUS</i>	6-104
<i>SECTION 648 -- SOD</i>	6-105
<i>SECTION 650 -- PLANTING - GENERAL</i>	6-107
<i>SECTION 651 -- EVERGREEN TREES</i>	6-115
<i>SECTIONS 652 AND 653 -- DECIDUOUS TREES</i>	6-116
<i>SECTION 654 -- EVERGREEN SHRUBS</i>	6-117
<i>SECTIONS 655 AND 656 -- DECIDUOUS SHRUBS</i>	6-118
<i>SECTION 657 -- VINES AND GROUND COVERS</i>	6-120
<i>SECTION 658 -- TRANSPLANTING PLANT MATERIAL</i>	6-121
<i>SECTION 692 -- MOBILIZATION</i>	6-122
<i>SECTION 693 -- TRAINING PROGRAMS</i>	6-123
<i>SECTION 698 -- FIELD FACILITIES</i>	6-126
<i>SECTION 699 -- MISCELLANEOUS TEMPORARY EROSION AND SEDIMENT CONTROL</i>	6-132

**DIVISION 7 00 -- MATERIALS**

**7-1**

<i>SECTION 702 -- BITUMINOUS MATERIALS</i>	7-1
<i>SECTION 703 -- AGGREGATES</i>	7-2
<i>SECTION 707 -- CEMENT MORTAR</i>	7-3
<i>SECTION 708 -- PAINTS</i>	7-4
<i>SECTION 716 -- WELDING OF ALUMINUM ALLOYS FOR HIGHWAY STRUCTURES</i>	7-28
<i>SECTION 718 -- RETROREFLECTIVE SHEETING</i>	7-32



**DIVISION 100 -- GENERAL PROVISIONS****SECTION 101 -- DEFINITIONS AND TERMS****101.01 General.**

The titles and headings of the Sections and Subsections are intended for convenience and do not bear on the meaning of the text.

When a publication is specified, it refers to the most recent date of issue, including all current updates and official interpretations, prior to the date of Proposal Bid opening for the Project unless the issue has a specific date or year specified.

Wherever the following abbreviations, terms, or pronouns are used in the Contract, the intent and meaning shall be interpreted as follows:

**101.02 Abbreviations:**

AAN	American Association of Nurserymen
AAR	Association of American Railroads
AASHTO	American Association of State Highway and Transportation Officials
ACI	American Concrete Institute
AGC	Associated General Contractors of America
AIA	American Institute of Architects
AISC	American Institute of Steel Construction
AISI	American Iron and Steel Institute
ANSI	American National Standards Institute
ARA	American Railway Association
AREMA	American Railway Engineering Maintenance-of-Way Association
ASCE	American Society of Civil Engineers
ASLA	American Society of Landscape Architects
ASME	American Society of Mechanical Engineers
ASTM	American Society for Testing and Materials
AWPA	American Wood-Preservers' Association
AWWA	American Water Works Association
AWS	American Welding Society
CFR	Code of Federal Regulations
CGP	Construction General Permit
CPM	Critical Path Method
EPA	Environmental Protection Agency
FHWA	Federal Highway Administration
FSS	Federal Specifications and Standards, General Services Administration
LRFD	Load and Resistance Factor Design
MUTCD	Manual on Uniform Traffic Control Devices
NEC	National Electric Code
NEMA	National Electrical Manufacturers Association
NEPCOAT	North East Protective Coating Committee
NTPEP	National Transportation Product Evaluation Program
NHDOT	The State of New Hampshire Department of Transportation
NPDES	National Pollutant Discharge Elimination system
OSHA	Occupational Safety and Health Administration
RSA	The New Hampshire Revised Statutes Annotated, 1955 together with all revisions amending same to date of invitation for bids
SAE	Society of Automotive Engineers
SSPC	Steel Structures Painting Council
UL	Underwriter's Laboratory
USACOE	United States Army Corps of Engineer

## SECTION 101

- 101.03 Accept or Acceptance.** Unless otherwise explicitly stated, these words refer to the Engineer's acceptance of work or materials for the purpose of initiating a Progress Payment(s) to the Contractor.
- 101.03.1 Final Acceptance.** The formal written acceptance by the Commissioner indicating that the Contractor has complied with all requirements of the Contract and it has been completed in all respects.
- 101.04 Adjustment.** Increase or decrease in the Contract Time or Contract Amount in accordance with [108.07](#) or [109.04](#) respectively.
- 101.05 Advertisement.** A public announcement inviting bids for work to be performed or materials to be furnished.
- 101.06 Angle of Crossing.** The right or acute angle formed by the intersection of the centerline of the upper roadway with a line parallel to the face of the abutment of a bridge or with the centerline of a culvert.
- 101.07 Approved Material.** Material approved by the Engineer for use in the work.
- 101.08 Award.** The acceptance of a proposal by the Department pending Governor and Council approval.
- 101.09 Base Course.** One or more layers of specified or selected material of designed thickness placed on a properly prepared subbase or subgrade to support a surface course.
- 101.10 Bidder.** An individual, partnership, firm, corporation, or any combination thereof, or joint venture, submitting a Proposal.
- 101.11 Bid Bond.** See Proposal Guaranty. See 101.25.3.
- 101.12 Bid (Total).** Total dollar amount of the Proposal.
- 101.13 Bid Documentation.** All writings, working papers, computer printouts, charts, and all other data or compilations of data that contain or reflect information or calculations used by the Bidder to determine the Total Bid and Item Bid Price indicated in a submitted and opened Proposal, including but not limited to information relating to the determination and application of:
- Equipment rates
  - Overhead rates and related time schedules
  - Labor rates
  - Efficiency or productivity factors
  - Arithmetic extensions
  - Subcontractor and material supplier quotes
- Any manuals standard to the industry that are used by the Bidder in determining the Proposal may be included in the bid documentation by reference and shall show the name and date of the publication and the publisher.
- The term “ Bid Documentation” does not include documents provided by the Department for the Bidder’s use in the preparation of the Proposal.
- 101.14 Bid Schedule.** The schedule included in the Proposal, containing the estimated quantities of contract pay items for which Item Bid Prices are invited.
- 101.15 Bridge.** As provided by RSA 234:2, a structure having a clear span of 10 ft. or more measured along the center line of the roadway at the elevation of the bridge seats, spanning a water course or other opening or obstruction.
- 101.16 Calendar Day.** A day shown on the calendar.
- 101.17 Cement.** Unless otherwise designated, this term will refer to Portland cement.
- 101.18 Certificate of Compliance.** A document in the format prescribed in the Contract certifying that material incorporated in the Work complies with the Contract.
- 101.19 Change Order.** A revision to the Contract issued after Award. The Change Order establishes the increase or decrease to the Contract Quantities, Contract Amount or Contract Time, if any, for the revision in accordance with [104.02](#).
- 101.20 Commissioner.** The Commissioner of The State of New Hampshire Department of Transportation.
- 101.21 Complete in Place.** All work indicated to be completed as part of a Contract pay item except as may be otherwise specified under the Method of Measurement or Basis of Payment.

- 101.22 Completion (Project).** Completion of the Project occurs when the Contractor has completed all work required by the Contract; has satisfactorily executed and delivered all documents, certificates, and proofs of compliance required by the Contract, and has received Final Acceptance from the Commissioner.
- 101.23 Conduit.** Unless the connotation is to the contrary, a tube intended to carry electrical or other utilities.
- 101.24 Construction Zone.** As provided in RSA 266:20, a zone designated by the Commissioner. See [105.12](#).
- 101.25 Contract.** The written agreement between the State and the Contractor setting forth the obligations of the parties thereunder, including, but not limited to, the performance of the work and the basis of payment.

The Contract may include and not be limited to: the Invitation for Bids, Proposal, Contract Form, Proposal Guaranty, Standard Specifications, Supplemental Specifications, Special Provisions, Prosecution of Work, Traffic Control Plan, Special Attentions, general and detailed Plans, Standard Plans for Road and Bridge Construction, Working Drawings submitted for approval and accepted, and Change Orders, and authorized extensions to the Contract time.

1. **Proposal Form.** The prescribed form on which the Department requires the Bid to be submitted. See [102.02](#). The completed Proposal Form becomes part of the Contract upon award and execution of the Contract and includes the following:
2. **Proposal.** The Proposal Form as returned and submitted by the Contractor and containing the Contractor's Bid. The Proposal includes or states:
  - a. the location and description of the project;
  - b. the Bid Schedule;
  - c. the **Completion Date**, the date on which specific work; or the Contract is specified to be completed ;
  - d. the amount of the Bid Bond;
  - e. the date, time, and place of the opening of bids;
  - f. certification of *Suspension or Debarment*;
  - g. certification of *Free Competitive Bidding* (for federal projects), or *Noncollusive Bidding* (for state projects);
  - h. certification of *Previous EEO Performance* (for federal projects);
  - i. certification of *Lobbying Activities for Federal Aid Contracts* (for federal projects);
  - j. certification of *Disadvantaged Business Enterprise Participation* (for federal projects);
  - k. certification of *Nondiscrimination*.
3. **Proposal Guaranty.** The security furnished with a Proposal to guaranty that the Bidder will enter into the Contract if the Proposal is accepted. See [102.09](#).
4. **Agreements.** Binding documents between the Department and third parties that pertain to the use of water, materials, and other resources.
5. **Federal Contract Provisions.** Provisions required on federal-aid Contracts:
  - a. Contract Affidavit – Certification Regarding Suspension or Debarment;
    - Appendix A - Certification Regarding Suspension or Debarment;
  - b. Lobbying Activities - Limitation on use of Grant or Contract Funds for Lobbying;
  - c. Disadvantaged Business Enterprise Policy and Directory;
  - d. Buy America – Steel & Iron Products;
  - e. Convict Produced Material;
  - f. Form FHWA-1273;
  - g. 41 CFR 60-4 Affirmative Action Requirements.
6. **Specifications.** The compilation of Standard Specifications, Supplemental Specifications, Special Provisions, Special Attentions, and other requirements for the performance of prescribed work, including:
  - a. **Prosecution of Work.** Specific requirements and information unique to the Project, including the final and any intermediate completion dates.
  - b. **Traffic Control Plan.** Specific requirements and procedures for controlling traffic during the course of construction. It also allows the Contractor to submit for approval variations of such plan.
  - c. **Special Attentions.** Notices calling bidders' attention to issues applicable to an individual project.
  - d. **Special Provisions.** Additions and revisions to the standard and supplementary specifications applicable to an individual project.
  - e. **Supplemental Specifications.** Revisions to the *Standard Specifications*.
  - f. **Standard Specifications.** The current edition of this book (“*NHDOT Standard Specifications for Road and Bridge Construction*”) approved for general application and repetitive use.

## SECTION 101

7. **Plans.** The approved drawings (or exact reproductions) showing the locations, character, dimensions, and details of the project. As appropriate, plans include:
  - a. **Plan and Profile Sheets.** Sheets showing the alignment of the centerline, the profile of the existing and proposed terrain on that centerline, and other project information.
  - b. **Typical Sections.** A section showing the slope criteria for the roadway cut-and-fill slopes, the crown or cross-slope of the finished roadway, the lane(s) and shoulder widths, the thicknesses and tapers for the surfacing courses, the position of the profile grade line, and the Clear Zone.
  - c. **Summary Sheets.** Sheets indicating the general notes, materials and rates information, and quantities and locations for pay items included in the Contract.
  - d. **Project Specific Detail Sheets.** Details that supplement the plan and profile sheets and provide material, earthwork, or other project specific information.
  - e. **General Cross-Sections and Earthwork.** Sections that indicate the existing and proposed terrain at intervals along the centerline and are used to determine the excavation and embankment limits. The areas developed from the cross-sections and the length of the intervals between sections used to calculate earthwork volumes.
  - f. **Standard Plans.** The New Hampshire “Standard Plans for Road and Bridge Construction” approved for general application and repetitive use.
8. **Addenda.** Contract Revisions issued after advertisement and before the opening of bids.
9. **Notice to Proceed.** Written authorization from the Department to the Contractor to start work on the project.
10. **Working Drawings for Approval.** Drawings, diagrams, illustrations, schedules, calculations, or other supplemental forms of information for physical items permanently incorporated in the project that the Department requires the Contractor to submit for approval and approved in accordance with [105.02](#).
11. **Contract Revision.** A written change to the Contract in accordance with [104.02](#).

**101.26 Contract Administrator.** The field representative of the Engineer having direct supervision of the administration of the Contract for the State.

**101.27 Contract Amount.** The original amount Bid by the Contractor, shown as the “Bid Total” on the Bid Schedule.

**101.28 Contract Bond.** The approved form of security in compliance with RSA 447:16 executed by the Contractor and the Surety or Sureties, guaranteeing complete execution of the Contract, including the payment of all legal debts pertaining to the construction of the project. See [103.05](#).

**101.29 Contract Time.** The Working Days (time) allowed for completion of the Work, or phase of work, or the Completion Date stated in the Contract including authorized time extensions. See [108.07](#).

**101.30 Contract Total.** The Contract Amount plus any amount added or subtracted by contract revisions.

**101.31 Contract Pay Item.** A specifically described item of work for which a bid price is provided in the Proposal.

**101.32 Contractor.** The individual, partnership, firm, corporation, or any combination thereof, or joint venture, contracting with the State for performance of prescribed work. Said person or persons, acting directly or through an authorized agent or employee, shall be designated as the party of the second part to the Contract.

**101.33 Controlled Access Highway.** See right-of-way terms.

**101.34 Critical Path.** The longest continuous sequence of work for which the combined duration of the work's individual scheduled activities produces the minimum overall project duration. Activities on the critical path that control the project's completion:

- **Critical Activity.** Any activity on the critical path
- **Controlling Activity.** A Critical Activity that would normally be in progress at a given moment.
- **Milestone.** Fixed date marking the beginning or end of specific work; phases of work; or completion date(s) as specified in the Contract.

**101.35 Cul-De-Sac.** A local street open at one end only and with special provision for turning around.

**101.36 Culvert.** Any structure not classified as a Bridge that provides an opening under any roadway.

**101.37 Day.** Unless designated as a Working Day, or unless otherwise indicated, this term will mean a Calendar Day.

**101.38 Delay.** Any event, action, force, or factor that would cause the established Contract Time to be exceeded for performance of the Contract. See [108.07](#).

- a. **Compensable Delay.** An excusable delay for which the Contractor may be entitled to compensation.

- b. **Excusable Delay.** A delay beyond the Contractor's control and not caused by the Contractor's fault or negligence, which the Contractor could not have reasonably foreseen, and for which a Contract or phase time extension may be granted.
- c. **Noncompensable Delay.** Excusable delay for which the Contractor may be entitled to an extension of time but no additional compensation.
- d. **Nonexcusable Delay.** A delay that was reasonably foreseeable and within control of the Contractor for which no compensation or time extension will be granted.

- 101.39 Department.** The State of New Hampshire Department of Transportation, designated as the party of the first part to the Contract.
- 101.40 Department's Website.** <http://www.nh.gov/dot> or [www.nhdot.com](http://www.nhdot.com).
- 101.41 Differing Site Conditions.** See 104.02.
- 101.42 Digital Identification (DI).** The equivalent of signing before a notary public and placing in force the Debarment and Non-Collusion Affidavit certification on file with the Department.
- 101.43 Drive and Entrance.** See right-of-way terms.
- 101.44 Easement.** A right acquired by public authority to use or control property for a designated highway purpose.
- 101.45 Engineer.** The Assistant Commissioner of the Department, who is responsible for Engineering supervision of the construction, acting directly or through duly authorized representatives.
- 101.46 Equipment.** All machinery and attachments, together with the necessary supplies for upkeep and maintenance, and all tools and apparatus necessary for the proper construction and acceptable completion of the Work.
- 101.47 Erosion** "Wearing away of land by running water, waves, wind, ice, abrasion, and transportation." (New Hampshire Stormwater Manual (Published by NH Department of Environmental Services)).
- 101.48 Escrow of Bid Documentation.** Preservation of the Bid Documents, under 101.13, by the successful Bidder for use by the Department and Bidder in any claims or litigation between the two parties arising out of the Contract.
- 101.49 Executive Council.** Five-member governing body that approves State Contracts.
- 101.50 Expression: By or to the Engineer.** In order to avoid cumbersome and confusing repetition of expressions in these specifications, it is hereby provided that any and all of the following words or any form of such words, unless clearly indicated otherwise, shall be understood to be followed by the words "by the Engineer" or "to the Engineer" :  
Accepted, approved, authorized, condemned, considered, deemed necessary, contemplated, designated, determined, directed, disapproved, established, given, indicated, insufficient, ordered, permitted, rejected, required, reserved, satisfactory, specified, sufficient, suitable, suspended, unacceptable, or unsatisfactory.
- 101.51 Floodplain.** A nearly flat, alluvial lowland bordering a stream that is subject to inundation by floods.
- 101.52 Floodway.** Channel of a stream plus any adjacent flood plain areas that must be kept free of encroachment in order that the 100 year flood be carried without increases in flood heights of up to a maximum of 1.0 foot.
- 101.53 Force Account.** A basis of payment for revised work as provided for in 109.04.4.
- 101.54 Hazardous Material (toxic waste).** Material as defined by RSA 147-A.
- 101.55 Highway, Street, or Road.** A public way designated for purposes of vehicular travel or vehicular and pedestrian travel, including the entire area within the right-of-way.
- 101.56 Holidays.** The following days are legal holidays in the State of New Hampshire used in determination of working days:
- |   |                  |
|---|------------------|
| New Year's Day  | Labor Day        |
| Martin Luther King, Jr./Civil Rights Day                | Columbus Day     |
| Washington's Birthday (The third<br>Monday in February) | Veterans Day     |
| Memorial Day  | Thanksgiving Day |
| Independence Day  | Christmas Day    |

If any holiday listed above falls on Sunday, the following Monday shall be considered a holiday. If any holiday listed above falls on Saturday, the preceding Friday shall be considered a holiday.

## SECTION 101

- 101.57 Inspector.** The Engineer’s authorized representative assigned to make inspections of the Work.
- 101.58 Invasive Species.** An alien species whose introduction caused or is likely to cause economic or environmental harm or harm to human health (RSA 430:52 VII).
- 101.59 Invitation for Bids.** The advertisement for Proposals. The advertisement will indicate the time and place of the opening of Bid Proposals, the type and location of work to be performed, and the character and quantity of the Material to be furnished and provide information on how to obtain a Proposal Form.
- 101.60 Item Bid Price.** The price bid for one unit for a Contract pay item, provided in the Bid Schedule, including reasonable estimated costs for labor, materials, and equipment, plus reasonable proportionate shares of anticipated profit, overhead, and indirect costs.
- 101.61 Item Numbers and Section Numbers.** In these Specifications, items are numbered to correspond to sections. Each item shall be constructed in accordance with the specifications contained in the corresponding section.
- The section numbers are intended for convenience of reference only and do not bear on the meaning of the text. In case of discrepancy between what the numbers for items would indicate and the item as written in words, the item as written in words shall govern.
- 101.62 Laboratory.** The official testing laboratory of the Department at Concord. A “ recognized laboratory” is any laboratory that may be designated or approved by the Engineer.
- 101.63 Lane.** The portion of the traveled way for the movement of a single line of vehicles.
- 101.64 Limited Access Highway.** See right-of-way terms.
- 101.65 Limits of Construction.** An area with established boundaries, identified within the highway right-of-way or construction easements, where the construction is permitted.
- 101.66 Major and Minor Contract Items.** Any Contract pay item for which the original item bid price multiplied by the original item quantity exceeds the following minimum major item value based on total Contract Amount price or 3% of the total Contract Amount price, whichever is less. All other Contract items are considered as minor items.

Total Contract Amount	Minimum Major Item Value
≤ \$1,000,000.00	\$25,000.00
> \$1,000,000.00 to ≤ \$5,000,000.00	\$100,000.00
> \$5,000,000.00 to ≤ \$20,000,000.00	\$300,000.00
> \$20,000,000.00	\$600,000.00

If no major Contract items are identified using the above criteria, then the major item or items shall be the three (3) highest total dollar bid items, excluding Item 692 – Mobilization.

- 101.67 Materials.** Any substances specified for use in the construction of the Project and its appurtenances.
- 101.68 Median.** That portion of a divided highway separating the traveled ways for traffic in opposite directions.
- 101.69 Non-Participating Item.** As used on the Plans for Federal-aid projects, an item in which the cost is not shared by the Federal Government.
- 101.70 Notice to Proceed.** Written notice to the Contractor to proceed with the Contract work; also starts the Contract time, when applicable.
- 101.71 Operational Construction Signs.** Warning signs used to advise and guide motorists through or around areas within a construction zone. Typically these signs are mounted on portable supports for short-term, short-duration, and mobile conditions.
- 101.72 Pavement Structure.** The combination of subbase, base courses, and surface courses placed on a subgrade to support the traffic load and distribute it to the roadbed.
- 101.73 Permanent Construction Signs.** Warning signs used to advise motorists approaching a construction zone. Typically, these signs are mounted on posts and are in place for the duration of the project.
- 101.74 Points of Access.** See right-of-way terms.
- 101.75 Prequalification Statement.** A completed form on which the Contractor has furnished information as to its ability to perform and finance the Work. See [102.01](#).



- 101.76 Prime Contractor.** The Contractor as defined above.
- 101.77 Profile Grade.** The trace of a vertical plane intersecting the top surface of the proposed wearing surface, usually along the longitudinal centerline of the roadbed. Profile grade means either elevation or gradient of such trace according to the context.
- 101.78 Project (Project Site).** The specific section(s) of the proposed work together with all appurtenances to be constructed under the Contract and other locations designated by and in which the Department will allow construction activity or disturbance and may include the following, as approved by the Engineer:
- a. from the beginning to the ending station(s) of the project between the slope stakes;
  - b. area within the defined boundaries of a Construction Permit(s);
  - c. material sources;
  - d. disposal sites;
  - e. designated haul roads;
  - f. plant sites;
  - g. staging areas;
  - h. stockpiling sites; and
  - i. other locations identified or approved by the Engineer.
- 101.79 Qualified Products List (QPL).** A list of products prequalified by the Engineer as meeting the Contract requirements for specified materials to be incorporated into the Work. The list is maintained and updated yearly by the Bureau of Materials and Research.
- 101.80 Responsive Bid.** A bid that meets all the requirements of the invitation for bids.
- 101.81 Responsible Bidder.** A Bidder that the Department determines has the ability to perform the requirements of the Contract.
- 101.82 Right-of-Way.** A general term denoting land, property, or interest therein, usually in a strip, acquired for or devoted to transportation purposes.
- 101.83 Right-of-Way Terms:**
- Limited Access Highway.** A highway laid out under the provisions of RSA 230:45 and to which all ingress and egress from abutting tracts of land is prohibited after completion of the work.
- Controlled Access Highway.** A highway laid out under the provisions of RSA 230:45 and to which ingress and egress from abutting tracts of land may be permitted.
- Point of Access.** An opening in the right-of-way line through which ingress and egress from the highway to abutting tracts of land may be made. RSA 236:13.
- Drive and Entrance.** The roadway over which a vehicle must operate for ingress and egress from the highway to abutting tracts of land. RSA 236:13.
- 101.84 Roadbed.** The graded portion of a highway prepared as a foundation for the pavement structure and shoulders.
- 101.85 Roadside.** A general term denoting the area adjoining the outer edge of the roadway. Extensive areas between the roadways of a divided highway may also be considered roadside.
- 101.86 Roadside Development.** Those items necessary for the preservation or replacement of landscape materials and features that may include suitable plantings and other improvements or ground cover to preserve and enhance the appearance and stability of the highway right-of-way or acquired easements.
- 101.87 Roadway.** The portion of a highway within the limits of construction.
- 101.88 Rock.** Where used in these specifications, this term shall be construed to mean igneous, metamorphic, or sedimentary rock.
- 101.89 Secure Vault.** Service provided by the Department to accept electronic bids.
- 101.90 Sieve.** U.S.A. Standard Sieve, as defined in AASHTO M 92. Measure percent passing sieve by weight.
- 101.91 Shoulder.** The portion of the roadway contiguous with the traveled way for lateral support of base and surface courses and for accommodation of stopped vehicles, for emergency use.

## SECTION 101

- 101.92 Sidewalk.** That portion of the roadway primarily constructed for the use of pedestrians.
- 101.93 Solid Waste.** Shall mean material as defined by RSA 149-M.
- 101.94 Standardized Plant Names.** The official Code of Standardized Plant Names of the American Joint Committee on Horticultural Nomenclature.
- 101.95 State.** The State of New Hampshire.
- 101.96 Structures.** Bridges, conduits, culverts, catch basins, drop inlets, retaining walls, cribbing, manholes, headwalls, end sections, buildings, sewers, service pipes, underdrains, and other features that may be encountered in the Work and not otherwise classed herein.
- 101.97 Stump.** The part of a tree remaining in the earth after the stem or trunk falls or is cut off; a standing tree trunk from which the upper part and the branches have been removed.
- 101.98 Subbase.** Layers of specified material thickness placed on a subgrade to support a base course.
- 101.99 Subcontractor.** An individual, partnership, firm, corporation, or any combination thereof, or joint venture, to whom the Contractor sublets any part of the Contract.
- 101.100 Subgrade.** The top surface of a roadbed upon which the pavement structure and shoulders are constructed.
- 101.101 Subsidiary and Subsidiary Item.** These terms are used to indicate work for which no direct payment will be made. Such work is considered to be incidental to Contract pay items, and the bid prices submitted by the Contractor shall be sufficient to absorb the cost of all work designated as subsidiary or as subsidiary items.
- 101.102 Substructure.** All of that part of a Bridge below the bearings of simple and continuous spans, skewbacks of arches, and tops of footings of rigid frames, together with the backwalls and wingwalls.
- 101.103 Superintendent.** The Contractor's authorized representative in responsible charge of the work.
- 101.104 Superstructure.** The entire Bridge except the substructure.
- 101.105 Surcharge.** Temporary load placed for the purpose of consolidating the underlying soil.
- 101.106 Surety.** The corporation, partnership, or individual, other than the Contractor, executing a bond furnished by the Contractor.
- 101.107 Surface Course.** One or more layers of a specified material of designed thickness, to accommodate the traffic load, placed on base courses. The top layer is sometimes called the "wearing course."
- 101.108 Topsoil.** The surface layer of soil and sod encountered during construction.
- 101.109 Traffic.** The movement of vehicles, pedestrians, animals, and any other conveyance either singly or together through an area of the project or along a route.
- 101.110 Traffic Control Device.** As defined in the MUTCD, all signs, signals, markings, and devices placed on, over, or adjacent to a street or highway by authority of a public body or official having jurisdiction to regulate, warn, or guide traffic.
- 101.111 Traffic Lane.** See Lane.
- 101.112 Traveled Way.** The portion of the roadway provided for the movement of vehicles, exclusive of shoulders.
- 101.113 Unbalanced Bid, Materially.** A Bid that generates a reasonable doubt that award to the Bidder submitting a mathematically unbalanced bid will result in the lowest ultimate cost to the Department. See [102.08](#).
- 101.114 Unbalanced Bid, Mathematically.** A Bid containing unit bid items that do not reflect reasonable costs plus a reasonable proportionate share of the bidder's anticipated profit, overhead costs, and other indirect costs. See [102.08](#).
- 101.115 Unit (Lump Sum).** A single amount basis of payment for a complete Contract item as defined by the Contract.
- 101.116 Wear.** The percent of wear of aggregate as determined by the AASHTO T 96 (Los Angeles Abrasion Test). The grading shall be Grading A unless otherwise specified.
- 101.117 Wetland.** "An area that is inundated or saturated by surface or ground water at a frequency and duration sufficient to support and that under normal conditions does support, a prevalence of vegetation typically adapted for life in saturated soil conditions. Wetlands include, but are not limited to swamps, marshes, bogs, and similar areas." (NH Code of Administrative Rules, Chapter Wt. 101.87, 1997)

- 101.118 Winter Suspension.** See Working Day (2).
- 101.119 Work.** The furnishing of all labor, materials, equipment, and incidentals necessary or convenient to the successful completion of the Project, and the carrying out of the duties and obligations imposed by the Contract.
- 101.120 Working Day.** Any calendar day, except:
- (1) Saturdays, Sundays, and Contract designated legal Holidays;
  - (2) the period from December 1 to April 1, inclusive;
  - (3) days where conditions identified in the Contract that require the Contractor to suspend construction operations;
  - (4) days where inclement weather or other conditions beyond the Contractor's control, prevent prosecution of the scheduled work with at least 75 percent of the normal daily labor and equipment force on the controlling activity for at least 60 percent of the daily hours routinely worked.
- Should the Contractor prepare to begin work on any day on which inclement weather, or the conditions resulting from the weather, prevent the work from beginning at the usual starting time, and the crew is dismissed as a result, the Contractor will not be charged for a working day whether or not conditions change during the day and the rest of the day becomes suitable for construction operations.
- 101.121 Working Drawings.** Working Drawings may be submitted for approval or documentation. See [105.02](#).

## SECTION 102

### ***SECTION 102 -- BIDDING REQUIREMENTS AND CONDITIONS***

#### **102.01 Prequalification of Bidders.**

In order that the Department may establish the rating or competency of those who propose to become bidders, at least ten days before submitting a proposal, a prospective bidder shall provide the Department with a completed prequalification application and a confidential financial statement, in accordance with the New Hampshire Code of Administrative Rules Part Tra 401, on a form furnished by the Department. Certification by a public accountant may be required. The statement shall include a complete report of the prospective bidder's financial assets and liabilities, equipment owned or leased, past and current work history, organizational structure including supervisory personnel, and references. In the event that any prospective Bidder fails to submit a prequalification statement as prescribed above, the Department will refuse to supply such prospective Bidder with a Proposal Form.

Bidders shall prequalify at least once a year.

A prequalification questionnaire and regulations may be obtained by prospective Bidders from the Department's Bureau of Finance & Contracts.

Prequalification status may be changed during the year upon submission of additional favorable reports or upon evidence of unsatisfactory performance as determined by the Department. Prequalification will establish the bidder's capacity to submit Proposals on individual projects of a given size or for a particular type of work.

#### **102.02 Contents of Proposal Forms.**

The Proposal Form will state the location and description of the proposed construction, will show the estimate of the various quantities and kinds of work to be performed or materials to be furnished, and will have a schedule of items for which Item Bid Prices are invited. The Proposal Form will state the Contract time, the amount of the Proposal Guaranty, and the date, time, and place of the opening of Proposals. The Proposal will include a statement regarding anti-trust activities, collusion, and restraint of free competitive bidding. The Proposal Form will also include Supplemental Specifications, Special Provisions, Special Attentions and other requirements that are not contained in the Standard Specifications.

All papers bound with or attached to the Proposal Form are considered a part thereof and must not be detached or altered when the Proposal is submitted, except for amendments authorized in writing by the Department.

The plans, specifications, and other documents referenced in the Proposal Form will be considered a part of the Proposal, whether attached or not.

The prospective Bidder will be required to pay the Department the sum stated in the Invitation for Bids for each copy of the Proposal and each set of plans obtained.

#### **102.03 Issuance of Proposal Form.**

The Department reserves the right to disqualify a Bidder as non-responsive or refuse to issue a Proposal Form to a prospective Bidder for any of the following reasons:

- A. Lack of competency or of adequate machinery, plant, or other equipment, as revealed by the prequalification statement required under 102.01.
- B. Uncompleted work which, in the judgment of the Department, might hinder or prevent the prompt completion of additional work if awarded.
- C. Failure to pay, or satisfactorily settle, all bills due for labor and material on former Contracts.
- D. Failure to comply with any prequalification regulations of the Department.
- E. Default under previous Contracts.
- F. Unsatisfactory performance on previous or current Contract(s).
- G. Misconduct that is of such a serious nature as to adversely affect the ability of the Contractor to perform future work.
- H. Failure to reimburse money owed on any previously awarded Department Contracts including those where the prospective bidder is a party to a joint venture and the joint venture has failed to reimburse the Department for money owed.
- I. The estimated value of the proposed Contract exceeds the current capacity rating of the Contractor.
- J. The estimated value of the proposed Contract exceeds the Contractor's bonding capacity.

Prospective Bidders who have not been prequalified may be furnished a proposal marked as " Sample Proposal, Not for Bidding Purposes." Such sample proposals will not be accepted by the Department as a valid Proposal.

#### **102.04 Interpretation of Quantities in the Bid Proposal.**

The quantities appearing in the Bid Proposal are estimates used for the comparison of bids. Payment to the Contractor will be made only for the actual quantities of work performed and accepted or materials furnished in accordance with the Contract. The

estimated quantities of work to be performed and materials to be furnished may each be increased, decreased, or eliminated in their entirety in accordance with 104.02, 109.03 and 109.11.

#### 102.05 Examination of Plans, Specifications, Special Provisions, Proposal, and Project Site.

The Bidder is expected to examine carefully the proposed Project Site and Proposal Form before submitting a Proposal. The bidder is responsible for all site conditions that should have been discovered had a reasonable site investigation been performed. The submission of a Proposal will be considered conclusive evidence that the bidder is satisfied with the conditions to be encountered in performing the requirements of the proposed Contract. It will be assumed that the Bidder has also investigated and is satisfied with the sources of supply for all materials.

Whenever boring logs or other records of subsurface investigations obtained by the Department are available for a Bidder's inspection, it is understood that these records have been obtained with reasonable care and recorded in good faith. The information is made available to bidders so all may have access to the identical subsurface information available to the Department and is not intended as a substitute for the personal investigations, interpretations, and judgment of the bidders.

Boring logs and other subsurface investigation records are available for inspection at the office of the Department's Bureau of Materials & Research, prior to the bid opening by appointment with 72 hours advance notice. Copies of these records are also available during the bidding period at the office of the Associated General Contractors of New Hampshire, Inc., Bow, New Hampshire.

There is no warranty or guarantee, either expressed or implied, that the conditions indicated by such investigations or records are representative of those conditions existing throughout such areas, or any part thereof, or that unforeseen conditions will not occur, or that materials other than, or in proportions different from those indicated, will not be encountered.

The word "rock" or the word "ledge" or the symbol for rock or ledge wherever used on the Plans shall be interpreted to mean only that rock may exist at the indicated elevations.

The Department will not be bound by any statement or representation concerning conditions or description of work unless they are included in the Contract. Oral explanations or instructions given before the award of the Contract by Department employees or agents will not be binding.

Any request for explanation of the meaning or interpretation of the Proposal Form shall be submitted at least five (5) days before the hour and date set for the bid opening to allow a reply to reach all bidders before submission of their Proposal. Interpretations or explanations made by the Department in response to such requests will be issued as an Addendum to the Proposal Form. All revisions or corrections to the proposal will be made by a written Addendum posted on the [Department's Website](#) or sent by either certified mail or telefacsimile to prospective bidders. All Addenda shall be acknowledged by a signed telefacsimile to the Department.

#### 102.06 Familiarity with Laws.

The Bidder is required to have made itself familiar with all Federal and State laws and all local by-laws, ordinances, and regulations which in any manner affect those engaged or employed to perform the work or affect the materials or equipment used in the Contract or affect the conduct of the work, and no plea of ignorance or misunderstanding will be considered. If the Bidder shall discover any provision in the Contract which is in conflict with any such law, by-law, ordinance, or regulation, the Engineer shall be informed forthwith in writing.

#### 102.07 Preparation of Proposal.

The bidder shall submit the Proposal on either the paper forms provided by the Department, on previously approved, substantially identical, forms generated by computer software, or electronically utilizing the Department's secure vault service.

Bidders are expected to submit unit prices in dollars and cents. Unit prices extending more than two digits after the decimal will be rounded to the nearest whole cent. When rounding is required, \$.005 or more will be shown as the next higher cent.

When an item in the proposal contains a choice to be made by the bidder, the bidder shall indicate the choice in accordance with the specifications for that particular item. The Proposal submitted must be signed by the individual, by one or more members of the partnership, by one or more members or officers of each firm representing a joint venture, by one or more officers of a corporation, or by an agent of the Contractor legally qualified and acceptable to the Department. If the bid is made by an individual, the individual's name and post office address must be shown; by a partnership, the name and post office address of each partnership member must be shown; as a joint venture, the name and post office address of each member or officer of the firms represented by the joint venture must be shown; by a corporation, the name of the corporation and its business address must be shown, together with the name of the state in which it is incorporated, and the names, titles, and business addresses of the president, secretary, and treasurer.

- A. Paper Proposal.** The bidder shall specify an Item Bid Price, both in words and figures, for each item for which a quantity is given and shall also show the products of the respective unit prices and quantities in figures in the column provided. The total amount of the Proposal is to be obtained by adding the amounts of the several items. All the words and figures shall be in ink or typed. If a unit bid price already entered by the bidder on the Proposal is to be

## SECTION 102

altered, it should be crossed out in ink, the new unit bid price entered above or below it and initialed by the bidder, also in ink. In case of discrepancy between the prices in words and those in figures, the prices in words shall govern.

All Department Addenda to the Proposal must be acknowledged by the Bidder on the bid envelope supplied by the Department for the submitted bid documents.

The Proposal submitted must be signed in ink.

**B. Electronic Proposal.** The bidder shall submit a Proposal with an electronically affixed digital identification (ID). For the purpose of this provision, affixing a digital ID to the Proposal shall be the equivalent of signing before a notary public and placing in force the Debarment and Non-Collusion Affidavit certification on file with the Department.

By submitting an electronic Proposal, the bidder certifies that it has read, understands, accepts, acknowledges, and agrees to comply with all statements, conditions, and specifications in the electronic submittal, including acknowledgement of all Addenda.

### 102.08 Irregular Proposals.

Proposals will be considered irregular and may be rejected as non-responsive for any of the following reasons:

- A. There are unauthorized additions, conditional or alternate bids, or irregularities of any kind that may tend to make the Proposal incomplete, indefinite, or ambiguous as to its meaning.
- B. The bidder adds any provisions reserving the right to accept or reject an award, or to enter into a Contract pursuant to an award. This does not exclude a Proposal limiting the maximum gross amount of awards acceptable to any one bidder at any one bid letting, provided that selection of awards is made by the Department.
- C. The Proposal does not contain a unit price for each pay item listed except in the case of authorized alternate pay items.
- D. Any of the Item Bid Prices are Unbalanced Materially or Mathematically as defined in [Section 101](#).
- E. The paper Proposal is on a form (or in a format, if computer generated) other than that provided or approved by the Department, or if the form is altered or any part thereof is detached or incomplete.
- F. The paper Proposal is not properly signed or the electronic Proposal does not contain a digital ID.
- G. The paper Proposal is not typed or completed in ink.
- H. The paper Proposal does not include the bid documentation in a sealed container and the affidavit of bid documentation if required by the Contract.
- I. The Contractor fails to provide a properly executed Proposal Guaranty.
- J. The bidder fails to sign the non-collusive bidding certification.
- K. The Proposal fails to comply with any other material requirement of the Invitation for Bids.
- L. Mathematical errors.

### 102.09 Proposal Guaranty.

A Proposal will not be considered unless accompanied by a guaranty of the character and amount indicated in the proposal and made payable to the "Treasurer, State of New Hampshire." If a bid bond is used by the Bidder, it shall be prepared as follows:

- A. The bond shall be completed in a form acceptable to the Department, and
- B. The bonding company issuing the bond shall be licensed to transact business in the State of New Hampshire, and
- C. The bonding company shall be listed on the current list of "Companies Holding Certificates of Authority as Acceptable Sureties on Federal Bonds and as Acceptable Reinsuring Companies", as published by the United States Department of the Treasury, Fiscal Service, Circular 570.
- D. In the event that any irregularities are contained in the bid guaranty, the bidder will have seven (7) calendar days from the time the bids are opened to correct the irregularities. If such irregularities are not corrected to the satisfaction of the Department, the Proposal will be rejected.

**102.09.1 Electronic Proposal.** A bidder submitting an electronic Proposal through the Department's secure vault service shall submit an electronic corporate surety bid bond. The corporate surety bond shall accompany each electronic Proposal. A bidder must arrange with its bonding agent to obtain an electronic bid bond and bid bond code. The bid bond code shall be submitted with the electronic Proposal.

### 102.10 Delivery of Proposal.

- A. **Paper Proposals.** Paper Proposals shall be placed in a sealed envelope plainly marked to indicate its contents, and addressed to the Department at the address shown on the Invitation for Bids. Sealed Proposals shall be received and deposited in the Bid Box at the location specified prior to the time and date specified in the Invitation for Bids. It shall be the Bidder's responsibility to ensure the Proposal is deposited as specified. Proposals delivered to the Department by alternate means are submitted at the sole risk of the Bidder. The Department will not accept

responsibility for any reason if the Proposal is not deposited in the Bid Box by the specified time and date. Proposals received after the time for opening of bids will be returned to the bidder unopened.

- B. Electronic Proposals.** Electronic Proposals shall be submitted electronically utilizing the Department's Secure Vault service. When a Proposal is submitted electronically through the secure vault service, the bidder shall "sign" the Proposal with a digital identification (ID). A bidder submitting an electronic Proposal through the secure vault service is solely responsible for that submission. Claims will not be accepted and bid openings will not be postponed due to default on the part of the bidder in preparing and submitting an electronic Proposal in a timely manner. All other bidding requirements apply to the submission of electronic Proposals.

#### 102.11 Withdrawal or Revisions of Proposals.

- A. Paper Proposals.** A bidder may withdraw or revise a Proposal after it has been delivered to the Department provided the request for withdrawal or revision is received by the Department in writing before the time set for receipt of proposals.
- B. Electronic Proposals.** An electronic Proposal submitted through the Department's secure vault service may be changed and resubmitted as many times as desired prior to the time set for the opening of Proposals specified in the *Invitation for Bids*. The latest time-stamped, electronically submitted, Proposal prior to the time set for opening bids will constitute the Proposal. Once the time set for opening of Proposals has passed, a Proposal cannot be withdrawn or revised.

#### 102.12 Combination Proposals.

If the Department so elects, Proposals may be issued for projects in combination or separately, so that Proposals may be submitted either on the combination or on separate units of the combination. The award of combination Proposals or separate Proposals will be made to the advantage of the Department. No combination Proposals, other than those specifically set up in the proposals by the Department, will be considered. Separate Contracts will be written for each individual project included in the combination.

#### 102.13 Public Opening of Proposals.

- A. Paper Proposals.** Paper Proposals will be opened and read publicly at the time and place indicated in the Invitation for Bids.
- B. Electronic Proposals.** Electronic Proposals submitted through the Department's secure vault service will be accessed, decrypted, printed to paper or otherwise made accessible in readable format at the time specified in the Invitation to Bids. Apparent total bid amounts will be made immediately available to the public. All bid results confirmed as formal after analysis will be published and posted on the [Department's Website](#). In the event of technical difficulties in opening electronic bids, the Department may postpone the reading of bids for that contract. All bids for a contract will be opened at the same time and location.

#### 102.14 Disqualification of Bidders.

Either of the following reasons will be considered sufficient for the disqualification of a bidder and the rejection of a Proposal:

- A.** More than one Proposal for the same work from an individual, firm, or corporation under the same or different name.
- B.** Evidence of collusion among bidders. Participants in such collusion will be disqualified as bidders for any future work of the Department until they are reinstated as qualified bidders.

#### 102.15 Materials Statement.

The successful bidder shall, when requested, furnish a complete statement of the origin or supplier of materials to be used in the construction of the work, together with samples to be tested for conformance with the Contract provisions.

#### 102.16 Non-Collusive Bidding Certification.

Every Proposal submitted to the Department shall contain the following statement affirmed by the bidder as true under the penalties of Law. This Certification, on Department forms, shall be signed by the bidders and submitted with the bid documents.

Non-Collusive Bidding Certification:

By submission of this Proposal, each bidder and each person signing on behalf of any bidder, certifies as to its own organization, under penalty of perjury, that to the best of their knowledge and belief:

1. The prices in this Bid Proposal have been arrived at independently without collusion, consultation, communication, or agreement with any other bidder or with any competitor for the purpose of restricting competition.

## SECTION 102

2. Unless required by law, the prices that have been quoted in this Bid Proposal have not been knowingly disclosed and will not knowingly be disclosed by the bidder, directly or indirectly, to any other bidder or competitor prior to opening of Proposals.
3. No attempt has been made or will be made by the bidder to induce any other person, partnership, or corporation to submit or not to submit a proposal for the purpose of restricting competition.
4. The signers of the Proposal hereby tender to the Department this sworn statement that the named Contractor(s) has not, whether directly or indirectly, entered into any agreement, participated in any collusion, or otherwise taken any action to restrain free competitive bidding in connection with this Proposal.
  - A. A Bid Proposal will not be considered for award nor will any award be made where there has not been compliance with the statements in the certification above.
  - B. The fact a bidder (1) has published price lists, rates, tariffs covering items being procured, (2) has informed prospective customers of proposed or pending publication of new or revised price lists for such item, or (3) has sold the same items to other customers at the same prices being bid, does not constitute a disclosure within the meaning of part 1 of the certification above.



**SECTION 103 -- AWARD AND EXECUTION OF CONTRACT****103.01 Consideration of Proposals.**

After Proposals are opened and read, they will be compared on the basis of summation of the products of the quantities and the Item Bid Prices unless otherwise defined in the Proposal Form. The results of the comparisons will be available to the public. If a discrepancy exists between the total shown in the bid and that obtained by adding the products of the quantities of items and the Item Bid Prices, the latter shall govern. The Department reserves the right to reject any or all Proposals, waive technicalities, correct minor discrepancies, or advertise for new Proposals if, in the judgment of the Commissioner, the best interests of the State will be promoted thereby.

**103.02 Award of Contract.**

Within 60 calendar days after the opening of Proposals, if a Contract is to be awarded, the award will be made to the prequalified bidder who submits the lowest priced responsive Proposal. The successful bidder will be notified by letter mailed to the address shown on the Proposal of the acceptance of the Proposal pending Governor and Council approval. If the Contract is not awarded by the Department and approved by the Governor and Council within 60 days after the opening of Proposals, the bidder has the right to withdraw the bid without penalty.

**103.03 Cancellation of Award.**

The Department may cancel the award of any Contract before execution without incurring any liability.

**103.04 Return of Proposal Guaranty.**

Proposal Guaranties, of all except those of the two lowest bidders, will be returned within seven (7) days following the opening of the Proposals. Irregular Proposals will have the Proposal Guaranties returned upon determination of the irregularity.

The retained Proposal Guaranties of the two lowest bidders will be returned within ten days following the approval by the Governor and Council of the award of the Contract. A Bidder will not be released from its bidding obligations because of errors in the preparation of the Proposal without forfeiting the Proposal Guaranty.

**103.05 Contract Bond.**

Unless specifically waived in the Proposal, upon execution of the Contract, the successful bidder shall furnish the Department a surety bond or bonds equal to the sum of the Contract amount. If a bond is used, it shall meet the following requirements:

- A. The form of the bond(s) shall be acceptable to the Department, and
- B. The bonding company issuing the bond(s) shall be licensed to transact business in the State of New Hampshire, and
- C. The bonding company issuing the bond(s) shall be listed on the current list of "Companies Holding Certificates of Authority as Acceptable Sureties on Federal Bonds and as Acceptable Reinsuring Companies," as published by the United States Department of the Treasury, Fiscal Service, Circular 570.

The Bonds shall guarantee the execution, faithful performance, and completion of the work to be done under the Contract, and payment in full of all bills and accounts for materials and labor used in the work.

In the event the surety or bonding company fails or becomes financially insolvent, the Contractor shall file a new bond(s) in the amount designated by the Department, within 30 calendar days of such failure or insolvency.

**103.06 Disadvantaged Business Enterprise (DBE) Program Requirements.**

The Department is required to set an overall annual goal for DBE participation in Federal-aid projects. In order to fulfill that goal, Bidders during the bidding stage and the low Bidder after the opening of bids are encouraged to demonstrate best efforts to utilize minority Subcontractors by soliciting bids from DBEs. These measures to obtain participation are known as race-neutral. Race-neutral DBE participation occurs when a DBE receives a prime Contract through customary competitive procurement procedures, is awarded a subcontract on a prime Contract that does not carry a DBE Contract goal, or even if there is a DBE Contract goal, wins a subcontract from a prime Contractor that did not consider its DBE status in making the award (e.g. prime Contractor that uses a strict low bid system to award subcontracts). The Department will use Contract goals as a race-conscious means of meeting any portion of the overall goal not achieved by use of race-neutral means.

A DBE is defined as a business that is owned and controlled by one or more socially and economically disadvantaged person(s). For the purpose of this definition:

- (1) "Socially and economically disadvantaged person" means an individual who is a citizen or lawful permanent resident of the United States and who is a Woman, Black, Hispanic, Portuguese, Native American, Asian American, or a member of another group, or an individual found to be disadvantaged by the Small Business Administration pursuant to Section 3 of the Small Business Act.

## SECTION 103

(2) “Owned and controlled” means a business which is:

- (a) a sole proprietorship legitimately owned and controlled by an individual who is a disadvantaged person.
- (b) a partnership, joint venture or limited liability company in which at least 51% of the beneficial ownership interests legitimately are held by a disadvantaged person(s).
- (c) a corporation or other entity in which at least 51% of the voting interest and 51% of the beneficial ownership interests legitimately are held by a disadvantaged person(s).

The disadvantaged group owner(s) or stockholder(s) must possess control over management, interest in capital, and interest in earnings commensurate with the percentage of ownership. Disadvantaged participation in a joint venture must also be based on the sharing of real economic interest and must include proportionate control over management, capital, and earnings, as above.

If the disadvantaged group ownership interests are real, substantial, and continuing and not created solely to meet the requirements of this program, a firm is considered a bona fide DBE.

A current listing of certified DBEs that may wish to participate in the highway construction program and the scope of work for which they are certified will be in the Proposal.

Credit will be given for the value described by a DBE performing as:

- A. A prime Contractor; actual value of work performed by own forces.
- B. An approved Subcontractor; 100% of expenditures committed.
- C. An owner-operator of construction equipment; 100% of expenditures committed.
- D. A manufacturer; 100% of expenditures committed.  
The manufacturer must be a firm that operates or maintains a factory or establishment that produces on the premises the materials or supplies obtained by the Contractor.  
Brokers and packagers shall not be regarded as manufacturers.
- E. A regular dealer; 60% of expenditures committed.  
A regular dealer is defined as a firm that owns, operates, or maintains a store, warehouse, or other establishment in which the materials or supplies required for the performance of the Contract are bought, kept in stock, and regularly sold to the public.  
Brokers and packagers shall not be regarded as regular dealers.
- F. A renter of construction equipment to a Contractor; 20% of expenditures committed, with or without operator.
- G. A bona fide service provider; 100% of reasonable fees or commissions.  
Eligible services include professional, technical, consultant, or managerial, services and assistance in the procurement of essential personnel, facilities, equipment, materials, or supplies required for the performance of the Contract.  
Eligible services also include agencies providing bonding and insurance specifically required for the performance of the Contract.
- H. A trucking, hauling, or delivery operation.  
100% of expenditures committed when trucks are owned, operated, licensed and insured by the DBE and used on the Contract and, if applicable, includes the cost of the materials and supplies.  
100% of expenditures committed when the DBE leases trucks from another DBE firm including an owner-operator.  
100% of reasonable fees or commissions the DBE receives as a result of a lease arrangement for trucks from a non-DBE, including an owner-operator.
- I. Any combination of the above.

On all Federal-aid projects, the Contractor, during the life of the Contract and on a semi-annual basis for the periods covering October 1st–March 31st and April 1st–September 30th shall submit a listing of all DBEs that were engaged in the Work, specifying item(s) of work performed by each DBE and the dollar amount paid for each item of work. Copies of canceled checks to the DBEs or statements from the DBEs together with supporting documentation (i.e., billings, invoices, etc., referenced to the Contract) must be submitted as proof of payment. This documentation shall be submitted to the Department within 30 days of the reporting period end. Failure of the Contractor to submit this information may result in the Department withholding progress payments.

On Federal-aid projects that specify a DBE Contract goal in the Information Report, Bidders during the bidding stage and the low Bidder after the opening of the bids, shall make every reasonable good faith effort to use certified disadvantaged business enterprises for work to be performed under the proposed Contract. In addition the following is also required on Federal-aid projects which specify a DBE Contract goal:

Within 3 working days after the bid opening date, the low Bidder shall file with the NHDOT Office of Federal Compliance a Disadvantaged Business Enterprise (DBE) Commitment Form provided by the Department. This form will list the DBE firms that will be used during the execution of the Work. The list shall show the name of the firm, the item/material/type of work involved and the dollar amount of work to be performed. The dollar total of each commitment shall be totaled and a percentage determined. In

addition to the commitment form, letters of intent signed by principals of the low bidder and each DBE firm listed, shall be submitted prior to Department approval of the DBE commitment.

If the low bidder cannot provide the list and accepted letters of intent showing DBE participation in the Work, within the above time frame, the Contractor may request additional time through the Department's DBE Liaison Officer to comply or to provide written documentation of efforts to obtain participation. Acceptable documentation showing all good faith efforts made to obtain participation may be reason to waive the goal requirement of the project.

Failure to provide the required listing with the dollar participation total or acceptable documentation of good faith efforts to obtain DBE participation within 3 working days after the bid opening date, or by another deadline established by the DBE Liaison Officer will be considered a lack of responsiveness on the part of the low bidder. Rejection of the low bid under these circumstances will require the low bidder to surrender the Proposal Guaranty to the Department.

The submission and approval of the above forms does not constitute a formal subcontract as required in 108.01.

If for any reason during the progress of the Work the Contractor finds that DBEs included on the list are unable to perform the proposed work, the Contractor, with written release by the committed DBE or approval of the Department, may substitute other DBE firms for those named on the list.

If the Contractor is able to document clearly his inability to find qualified substitute firms to meet the project goal, the Contractor may request in writing a waiver of that goal.

If at any time during the life of the Contract it is determined that the Contractor is not fulfilling the goal or commitment(s) and is not making a good faith effort to fulfill the DBE requirement, the Department may withhold progress payments.

Failure of the Contractor to meet the project goal or the specified DBE commitment(s), whichever is the lowest, will result in a reduction in Contract payment by an amount equal to the difference between the actual Contract dollars multiplied by the applicable commitment percentage and the dollar value of the work actually performed by the DBEs. If the Contractor's failure to meet the DBE goal or commitment(s) in the Contract is the result of circumstances clearly documented to be beyond the control of the Contractor, a written request for waiver of the goal or commitment(s) must be received. The Commissioner may waive, in whole or part, the reduction in Contract payments specified herein.

Fulfillment of the goal percentage shall be determined by dividing the dollars committed to the DBEs by the Contract Amount.

These requirements are in addition to all other Equal Employment Opportunity requirements on Federal-aid Contracts.

#### **103.07 Execution and Approval of Contract.**

The signed Contract, together with the Contract Bond, certificate of insurance, and the Disadvantaged Business Enterprise forms, if required, shall be returned to the Department within 20 days after the date of notice that the Proposal has been accepted. The Contract will not be considered approved until it has been fully executed by all of the parties to the Contract and the award approved by the Governor and Executive Council.

#### **103.08 Failure to Execute Contract.**

If the successful bidder fails to execute the Contract and file an acceptable bond within 20 days after the date of notice of acceptance of the Proposal, the Department may cancel the notice of award and retain the bidder's Proposal Guaranty which shall become the property of the Department, not as a penalty, but in liquidation of damages sustained. Contract award may then be made to the next lowest responsible bidder or the Work may be readvertised.

## SECTION 104

### *SECTION 104 -- SCOPE OF WORK*

#### **104.01 Intent of Contract.**

The intent of the Contract is to provide for the construction and completion in every detail of the work it describes. The Contractor shall furnish all labor, materials, equipment, tools, transportation, services, and supplies required to complete the Work under the Contract.

#### **104.02 Revisions to the Contract.**

##### **A. General.**

The Department reserves the right to revise the Contract at any time. Revisions to the Contract neither invalidate the Contract nor release the surety, and the Contractor agrees to perform the Work as revised. The Contractor shall not proceed with the revised Work until directed to do so by the Engineer, but shall continue with all work unaffected by the revision. Nothing contained in this section shall constitute a waiver of the State's sovereign immunity.

If the Contractor believes that it has encountered circumstances that necessitate a revision to the Contract, the Contractor shall immediately notify the Engineer in accordance with subsection 104.02.G. If the Contractor believes it has encountered a Differing Site Condition as set forth in 104.02.B, Significant Changes in the Character of Work as set forth in 104.02.C, or Suspensions of Work Ordered by the Engineer as set forth in 104.02.D, the Contractor shall provide notice as required by these clauses and as required by 104.02.G. Failure to provide notice as specified in 104.02.G constitutes a waiver of the Contractor's entitlement to compensation or a time extension and releases the State from responsibility for providing compensation or a time extension for any related claims filed under 105.18.

If the Engineer concludes that the Contract should be revised, as provided in 104.02.G.4, compensation will be provided in accordance with 109.04, and time extensions will be granted in accordance with 108.07. In addition, the term "adjustment" as used in 104.02.B, C, and D is defined as a time extension in accordance with 108.07 and compensation in accordance with 109.04. In 104.02.C, the phrase, "as provided elsewhere in the Contract," means as provided in 108.07 with regard to time extensions and in 109.04 with regard to compensation.

With regard to 104.02.D, Suspensions of Work, an adjustment is provided for suspensions or delays "caused by conditions beyond the control of and not the fault of the Contractor, its suppliers, or Sub-Contractors at any approved tier, and not caused by weather." The Contractor is also not entitled to an adjustment for suspensions or delays caused by the reasons set forth in 108.07.B, Excusable, Non-Compensable Delays.

The Department may revise the Contract for any of the reasons specified in 104.02.B. Differing Site Conditions; C. Significant Changes in the Character of Work; D. Suspension of Work; E. Extra Work, or F. Elimination of Work.

Sections 104.02.B, C, and D contain wording mandated by FHWA. As the terms "modification" or "change" are used in them they shall mean a Revision to the Contract.

##### **B. Differing Site Conditions.**

During the progress of the work, if subsurface or latent physical conditions are encountered at the Project Site differing materially from those indicated in the Contract or if unknown physical conditions of an unusual nature, differing materially from those ordinarily encountered and generally recognized as inherent in the work provided for in the Contract, are encountered at the site, the party discovering such conditions shall promptly notify the other party in writing of the specific differing conditions before the site is disturbed and before the affected work is performed.

Upon written notification, the Engineer will investigate the conditions, and if it is determined that the conditions materially differ and cause an increase or decrease in the cost and/or time required for the performance of any work under the Contract, an adjustment, excluding anticipated profits, will be made and the Contract modified in writing accordingly. The Engineer will notify the Contractor of the determination as to whether or not an adjustment of the Contract is warranted.

No Contract adjustment which results in a benefit to the Contractor will be allowed unless the Contractor has provided the required written notice.

No Contract adjustment will be allowed under this clause for any effects caused on unchanged work.

##### **C. Significant Changes in the Character of Work.**

The Engineer reserves the right to make, in writing, at any time during the work, such changes in quantities and such alterations in the work as are necessary to satisfactorily complete the Project. Such changes in quantities and alterations shall not invalidate the Contract nor release the surety, and the Contractor agrees to perform the work as altered.

If the alterations or changes in quantities significantly change the character of the work under the Contract, whether such alterations or changes are in themselves significant changes to the character of the work or by affecting other work cause such other work to become significantly different in character, an adjustment, excluding anticipated profit, will be made to the Contract. The basis for the adjustment shall be agreed upon prior to the performance of the work. If a basis cannot be agreed upon, then an adjustment will be made either for or against the Contractor in such amount as the Engineer may determine to be fair and equitable.

If the alterations or changes in quantities do not significantly change the character of the work to be performed under the Contract, the altered work will be paid for as provided elsewhere in the Contract.

The term “significant change” shall be construed to apply only to the following circumstances:

1. When the character of the work as altered differs materially in kind or nature from that involved or included in the original proposed construction; or
2. When a Major Item of work, as defined elsewhere in the Contract, is increased in excess of 125 percent or decreased below 75 percent of the original Contract quantity. Any allowance for an increase in quantity shall apply only to that portion in excess of 125 percent of original Contract item quantity, or in case of a decrease below 75 percent, to the actual amount of work performed.

#### **D. Suspensions of Work Ordered by the Engineer.**

If the performance of all or any portion of the work is suspended or delayed by the Engineer in writing for an unreasonable period of time (not originally anticipated, customary, or inherent to the construction industry) and the Contractor believes that additional compensation and/or Contract time is due as a result of such suspension or delay, the Contractor shall submit to the Engineer in writing a request for adjustment within 7 calendar days of receipt of the notice to resume work. The request shall set forth the reasons and support for such adjustment.

Upon receipt, the Engineer will evaluate the Contractor’s request. If the Engineer agrees that the cost and/or time required for the performance of the Contract has increased as a result of such suspension and the suspension was caused by conditions beyond the control of and not the fault of the Contractor, its suppliers, or Subcontractors at any approved tier, and not caused by weather, the Engineer will make an adjustment (excluding profit) and modify the Contract in writing accordingly. The Contractor will be notified of the Engineer’s determination whether or not an adjustment of the Contract is warranted.

No Contract adjustment will be allowed unless the Contractor has submitted the request for adjustment within the time prescribed.

No Contract adjustment will be allowed under this clause to the extent that performance would have been suspended or delayed by any other cause, or for which an adjustment is provided or excluded under any other term or condition of this Contract.

#### **E. Extra Work.**

If the Contractor believes that it has been required to perform work not originally in the Contract but found to be essential for the completion of the Contract, the Contractor shall notify the Engineer in accordance with 104.02.G. Failure to provide notice as specified in 104.02.G constitutes a waiver of the Contractor’s entitlement to compensation or a time extension and releases the State from responsibility for providing compensation or a time extension for any related claims filed under 105.18. If the Engineer determines that Extra Work is required, the Engineer will compensate the Contractor for the Extra Work in accordance with 109.04. Time extensions, if warranted, will be determined in accordance with 108.07.

#### **F. Eliminated Items.**

The Department may partially or completely eliminate Contract Pay Items. When notified of the elimination of a Contract Pay Item, if the Contractor believes that such elimination will necessitate a revision to the Contract Amount, the Contractor shall provide notice in accordance with 104.02.G. Failure to provide notice as specified in 104.02.G constitutes a waiver of the Contractor’s entitlement to compensation or a time extension releases the State from responsibility for providing compensation or a time extension for any related claims filed under 105.18. The Department will reimburse the Contractor for the actual Work completed in accordance with 109.04.

#### **G. Contractor Notification.**

1. **Contractor Initial Notification.** The Contractor shall provide immediate oral or written notification to the Engineer upon discovering a circumstance that the Contractor believes will require a revision to the Contract. Upon notification, the Engineer will attempt to resolve the identified issue as quickly as possible. No further work is to be performed or expense incurred related to the alleged revision unless directed otherwise in writing by the Engineer.
2. **Contractor Notice.** If the Engineer has not resolved the identified issue within 2 working days the initial notification was given by the Contractor, then the Contractor shall provide written notice to the Engineer of any circumstance that may require a revision to the Contract and shall contain the following information:
  - A. No further work is to be performed or expense incurred related to the alleged revision unless directed otherwise in writing by the Engineer.
  - B. Immediately notify the Engineer in writing of the alleged revision occasioned by the site conditions or actions by the Department and, within five days of the date that the alleged revision or action was noted, provide the following information to the Engineer in writing:
    1. The date of occurrence and the nature and circumstances of the occurrence that constitute a revision.

## SECTION 104

2. Name, title, and activity of each Department representative knowledgeable of the alleged revision
3. Identify any documents and the substance of any oral communication involved in the alleged revision.
4. Basis for belief that a delay occurred and a time extension is due. Also, provide the basis for any contention that accelerated performance was necessary and compensation due.
5. Basis for belief that the work is not required by the Contract.
6. Particular elements of Contract performance for which additional compensation may be sought under this Section including:
  - a. Pay item(s) that has been or may be affected by the alleged revision.
  - b. Labor or materials, or both, that will be added, deleted, or wasted by the alleged revision and what equipment will be idled or required.
  - c. Delay and disruption in the manner and sequence of performance that has been or will be caused.
  - d. Increases to Contract Amount(s), delivery schedule(s), staging, and Contract Time estimated due to the alleged revision.
  - e. Estimate of the time within which the Department must respond to the notice to minimize cost, delay, or disruption of performance.

The Engineer and Contractor shall maintain records of labor, equipment, and materials used or made necessary by the circumstance. Such record keeping shall start when notice is received by the Engineer.

3. **Written Acknowledgement, by Engineer.** The Engineer will acknowledge in writing the receipt of the Contractor's written notice.
4. **Final Written Response, by Engineer.** Within 5 working days of receiving the Contractor's written notice, unless the Contractor agrees to a longer time period, the Engineer will provide a written response that includes one of the following:
  - a. Confirmation of the need for a revision to the Contract. A time extension, if one is necessary, will be determined in accordance with 108.07. Compensation for the revision, if any is necessary, will be determined in accordance with 109.04. The Engineer will give direction to the Contractor regarding how to proceed with Work affected by the revision.
  - b. Denial of the request for a revision to the Contract, in which case the Engineer will explain why the issue does not represent a revision to the Contract. Upon receipt of such a denial, the Contractor shall immediately proceed with all Work that may have been halted due to the circumstances for which the Contractor provided notice.
  - c. A request for additional information or time for review, in which case the Engineer will identify what is needed and by when; the Engineer will issue a response within 5 working days of receiving the additional requested information.
5. **Contract Revisions Without Notification.** The Department will not make revisions to the Contract Amount or Contract Time allowed by 104.02.B, 104.02.C, 104.02.D, 104.02.E, 104.02.F, 104.04, 104.06, 104.09, 105.06 and 105.08 if the Contractor did not give notice as specified in 104.02.G.
6. **Contractor's Recourse.** If the Contractor disagrees with the Engineer's final written response or the Engineer's response is untimely, the Contractor may pursue a claim in accordance with 105.18.

### 104.03 Maintenance of Traffic.

The Contractor shall keep all roads open to all traffic during construction. Where provided in the Contract, or approved by the Engineer, traffic may be bypassed over an approved detour route. The Contractor may propose to construct detours not shown on the Plans. The Contractor shall submit proposed detour plans for documentation in accordance with 105.02, which shall show the proposed location, alignment, grade, typical cross section, protective fixtures and signing. The section of the project being used by public traffic shall be kept in a condition that safely and adequately accommodates traffic. The Contractor shall furnish, erect, and maintain barricades, warning signs, delineators, striping, flaggers, and pilot cars in accordance with the MUTCD and Sections 618, 619 and 632. The Contractor shall bear all expense of maintaining the section of road undergoing improvement including all temporary approaches or crossings and intersections with trails, roads, streets, businesses, parking lots, residences, garages, farms, and other features as may be necessary. Snow removal from the roadway is not required during winter work suspensions if all conditions set forth in 104.03.D and 619.3.1.9.1 are met. Payment for the furnishing, installation, and maintenance of traffic control will be as provided in Section 619. No other compensation for maintenance will be made except as provided below:

- A. **Detours.** When the Contract contains an item for "Construct and Remove Detours" or "Temporary Bridge," the payment for such items covers all costs of constructing, maintaining, and obliterating detours, including construction and removal of temporary bridges and accessory features. Right-of-Way for temporary highways or bridges designated in the Contract will be furnished by the Department.

**B. Maintenance of Traffic During Suspension of Work.**

1. Suspensions Ordered by the Engineer not caused by the Contractor or Winter Suspensions due to climatic conditions. The Contractor shall make passable and open to traffic the sections of the project and temporary roadways as agreed upon between the Contractor and the Engineer for the accommodation of necessary traffic during the anticipated period of suspension.

During this suspension period, the maintenance of the temporary roadway and sections of the Project will be the responsibility of the Department subject to 105.14.

When Work is resumed, the Contractor shall replace or restore any work or materials lost or damaged because of the temporary use of the Project and remove work or materials used in the temporary maintenance and complete the Project as though its prosecution has been continuous and without interference. Additional work caused by the suspension, for reasons beyond the Contractor's control, in accordance with 104.09 and 619.5.4 will be paid for at Contract prices or as provided for in 109.04.

2. Other Suspensions of Work. When Work is suspended for any other reason including but not limited to the following: for failure to correct conditions unsafe for the workers or the general public, for failure to carry out orders of the Engineer, or for other reasons caused by the Contractor, all costs for maintenance of the roadway to accommodate traffic during the suspended period shall be borne by the Contractor.

- C. **Maintenance Directed by the Engineer.** If the Engineer directs special maintenance for the benefit of the traveling public not otherwise included in the Contract, payment will be on the basis of Contract unit prices or under Subsection 104.02.C Significant Changes in the Character of Work. The Engineer will determine the work to be classed as special maintenance

- D. **Winter Maintenance Meeting.** All Projects, which will encompass construction activities over the course of two or more construction seasons, shall be required to hold a "Project Winter Maintenance Meeting" prior to October 15<sup>th</sup>. This meeting shall as a minimum involve personnel from the Contractor, Bureau of Construction, Division of Operations, and the local municipality, as appropriate. The meeting will serve to determine and document the work required by the Contractor prior to the winter maintenance season and the responsibilities of all the parties during that season. Should the Contractor fail to perform the required work in advance of the winter maintenance season, all costs for maintenance of the roadway to accommodate the safe flow of traffic during that period whether work is suspended or not shall be borne by the Contractor, including all snow removal costs.

**104.04 Rights In and Use of Materials Found on the Project.**

Materials found in the limits of excavation that are suitable for completing bid items of work may be used by the Contractor. The Contractor will be paid both for the removal of the material at the corresponding Contract unit price and for the pay item for which the removed materials are used.

Material within the grading limits below the roadway template may also be removed and used on the project without compensation from the Contractor; however, the Contractor will not be paid for the removal and replacement of this material. The replacement material shall be subject to the approval of the Engineer. The Engineer may prohibit excavation below the planned limits if such excavation and subsequent backfilling will cause damage, additional expense, loss of time or loss of structural integrity.

Material shall not be excavated or removed from within the highway Right-of-Way that is not within the grading limits without written authorization from the Engineer. Material authorized to be removed outside the grading limits may be subject to compensation from the Contractor at an agreed price at the time of authorization. Replacement material covered under 104.04 shall be compacted to the density requirements specified for roadway embankment construction.

It is expressly understood that the Contractor is not entitled to compensation for anticipated profits on the expected use of any materials shown on the Plans as existing and later found to be nonexistent or unfit for use.

Unless otherwise provided, the material from any structures scheduled for demolition or removal may be used temporarily by the Contractor in the erection of the new structure. Such material shall not be modified or otherwise damaged without approval.

Unless otherwise specified herein, or except as stated in Sections 202 and 502, the Contractor shall not take title to structures found on the highway. Such structures, including but not limited to catch basin frames and grates, drop inlet frames and grates, and manhole frames and covers, curbing, beam guardrail, guardrail fittings, pipe, traffic control devices, and all other materials designated to be salvaged, unless otherwise specified or directed, shall be carefully salvaged and stored within approved portions of the right-of-way or in other approved locations for loading by the Contractor onto State owned vehicles as directed. Care shall be taken during removal operations so as not to damage any salvaged materials. The Contractor shall remove and properly dispose of existing guardrail on abandoned sections of the highway as directed.

Structures and obstructions no longer an integral part of the work and not designated or directed for salvage, including guardrail posts, railroad ties, delineators, markers, cables, wire, light pole bases, signs, fence, gates, and any other visible obstruction to the Work, shall become the property of the Contractor, who shall use, recycle, or dispose of them properly at no expense to the State.

## SECTION 104

Removal and disposal of man-made materials that are not visible or designated for removal found within the limits of the project and that are not suitable for fill within the limits of the project or at a disposal site in accordance with 106.10, shall be the responsibility of the Contractor. Compensation for such removal and disposal will be in accordance with 104.02. All other work under this section, unless specifically provided for herein, or in other sections of the Contract, will not be paid for separately, but shall be considered as subsidiary.

### 104.05 Final Cleaning Up.

Before final inspection and acceptance of the Work, the Project Site, borrow, and local material sources and all elements used and areas occupied by the Contractor in connection with the Work shall be cleaned of all rubbish, excess materials, temporary structures, and equipment and all parts of the Work shall be left in an acceptable condition. The cost of final cleanup shall be subsidiary to other items and no separate payment will be made.

### 104.06 Restoration of Surfaces Opened by Permit.

Any individual, firm or corporation may be issued a permit by the proper authorities for entering the Project for the purpose of constructing or reconstructing any utility service. The Contractor shall allow the permit holder to enter and work within the Project limits for this purpose.

When ordered by the Engineer, the Contractor shall make necessary repairs due to the permit holder's work. The repairs will be Extra Work as provided for in 104.02.E.

### 104.07 Railway-Highway Provisions.

If the Contract requires that materials be hauled across the tracks of any railway, the Department will arrange with the railway for use of new crossings or any existing crossings. If the crossings other than those specified in the Contract are used, the Contractor shall make arrangements for the use of the crossings.

Work performed on the railway Right-of-Way shall be performed without interfering with the movement of trains or traffic of the railway company. The Contractor shall prevent accidents, damage, or unnecessary delay or interference with the railway trains or other property. If work on the railway Right-of-Way is to be performed by both the Contractor and Railway Company, the Contractor shall coordinate the work activities with the railway company work forces and schedule.

The Contractor shall secure from the railroad flagging service for the protection of railroad traffic during the progress of work by the Contractor on, over, under, or adjacent to the tracks of the railroad. Reimbursement of these services will be made by the Department to the Railroad through a Force Account agreement. If the railroad grants the Contractor's request for any temporary crossing or any temporary crossing is ordered by the Department's Bureau of Rail and Transit, due to the Contractor's construction method, the Contractor shall assume the cost of installing, maintaining, removing, and protecting such temporary crossing. The type and method of protection of the crossing and the insurance required shall be as determined by the railroad.

### 104.08 Construction Over or Adjacent to Navigable Waters.

Work over, on, or adjacent to navigable waters shall be conducted without interfering with free navigation of the waterways and so that the existing navigable depths will not be impaired except as allowed by permit issued by the U.S. Coast Guard or the U.S. Army Corps of Engineers, as applicable.

### 104.09 Contractor's Responsibility for Work.

Until Final Acceptance of the project by the Engineer, the Contractor is responsible for and shall protect the Work against injury or damage from all causes whether arising from the execution or the nonexecution of the Work except as provided in Subsection 104.03.B.1.

The Contractor, at their expense, shall rebuild, repair, restore, and make good all losses, injuries, or damage to any portion of the Work from any cause before Acceptance, except for loss, injury, or damage due to causes not under the control and without the fault or negligence of the Contractor. Causes not under the control of the Contractor include, but are not restricted to the following:

- A. **Damage by Occurrence.** This includes damage to the work in progress that is caused by natural disasters such as earthquake, tidal wave, tornado, hurricane, or other cataclysmic phenomenon of nature; acts of a public enemy; and acts of governmental authorities.
- B. **Damage by Public Traffic.** This includes damage to any permanent element of the highway which is completed to the stage of serving its intended function and is subsequently damaged by public traffic. It also includes damage to temporary impact attenuation devices during winter suspension.

The Contractor shall repair damage due to such excepted causes and shall be paid at the Contract prices or as provided for in 104.02 as determined and ordered by the Engineer. The Contractor will be reimbursed for damage caused by public traffic (not by vandalism or the Contractor's equipment) if unsuccessful in collecting the cost of repair from the responsible party. In order to be reimbursed, the Contractor must have made every reasonable effort to collect the costs from the person or persons responsible



for the damage. A reasonable effort will be considered to have been made if the Contractor certifies that the law enforcement agency having jurisdiction has been contacted in order to obtain the identity of the responsible person or persons, has corresponded in writing via certified mail with the responsible party and or his/her insurance company, if this information is available, and has failed to recover the cost of damages in spite of these efforts.

In case of suspension of the Work from any cause, the Contractor is responsible for the Work under the Contract and shall prevent damage to the project, provide for normal drainage, and erect necessary temporary structures, signs, or other facilities. The Contractor shall also maintain in an acceptable growing condition all living material in newly established plantings, seedings, and soddings furnished under the Contract, and protect new tree growth and other designated vegetative growth against injury. When work is suspended for reasons delineated in Subsection 104.03.B.2, the costs during the period of suspension shall be borne by the Contractor.

#### **104.10 Environmental Protection.**

The Contractor shall comply with all Federal, State, local laws, and regulations controlling pollution of the environment; and preventing the spread of prohibited invasive plants listed in Table 3800.1 of Part AGR 3800. Pollution of streams, lakes, ponds, and reservoirs with fuels, oils, bitumens, chemicals, suspended silt, or other harmful materials and pollution of the atmosphere from particulate and gaseous matter shall be avoided to the extent practicable. Detailed requirements implementing this policy are outlined in Section 107 and Contract documents.

#### **104.11 Value Engineering Change Proposals by the Contractor.**

The Contractor is encouraged to use ingenuity and experience to develop and offer any Value Engineering Change Proposal (VECP) to the Department for alternative construction designs, methods, procedures, and other innovations that result in a lower total cost, improved quality, or both. It is the intent of this provision to share with the Contractor any direct cost savings as a result of VECP(s) generated by the Contractor and approved by the Department. Any cost savings generated to the Contract as a result of a VECP shall be shared equally between the Contractor and the Department.

Bid prices shall not rely on the anticipated approval of any VECP(s) by the Department. If a VECP is rejected, the Work shall be completed per the Contract requirements at the bid prices. VECP(s) shall only be submitted by the Contractor after the Contract is awarded.

If the Department determines that the time for response indicated in the submittal under item C.5 below is insufficient for review, the Contractor will be promptly notified. Based on the additional time needed by the Department for review and the effect on the Contractor's schedule occasioned by the added time, the Department will evaluate the need for a time adjustment to the Contract in accordance with 108.07.

The Contractor shall have no claim against the Department for any delay to the Contract based on the failure to respond within the time indicated in item B.5 or C.5 below in the submittal if additional information is needed to complete the review.

- A. **Submittal of VECP – General.** VECP(s) that will be considered are those contemplated to produce a savings to the Department without impairing essential functions and characteristics of the facility including but not limited to, service life, economy of operation, ease of maintenance, desired appearance, safety, and impacts to the traveling public or the environment during and after construction.
- B. **Submittal of a Conceptual Proposal.** The Contractor may submit a conceptual proposal for preliminary evaluation for VECP(s) that require a significant amount of design or other development resources. The Engineer will evaluate the information provided and advise the Contractor if any conditions or parameters of the Conceptual Proposal are found to be grounds for rejection. Preliminary review of a Conceptual Proposal reduces the Contractor's risk of subsequent rejection but does not commit the Department to eventual approval of the full VECP. The following materials and information shall be submitted with each Conceptual Proposal:
  1. A statement that the proposal is submitted as a Conceptual VECP
  2. A general description of the difference between the existing Contract and the proposed change, and the advantages and disadvantages of each, including effects on cost, service life, economy of operation, ease of maintenance, desired appearance, safety, and impacts to the traveling public or the environment during and after construction.
  3. A set of conceptual plans and description of the proposed changes to the Contract requirements.
  4. An estimate of the anticipated cost savings.
  5. When a response to the Conceptual VECP by the Department is required.
  6. Amount of time necessary to develop a Full VECP.
  7. Date by which a Contract Change Order must be executed to obtain the maximum benefit from the VECP.
  8. The effect the VECP will have on the completion dates in the Contract.
- C. **Submittal of Full VECP.** The following materials and information shall be submitted with each Full VECP.
  1. A statement that the proposal is submitted as a Full VECP.

## SECTION 104

2. A description of the difference between the existing Contract and the proposed change, and the comparative advantages and disadvantages of each including effects on service life, economy of operations, ease of maintenance, desired appearance, safety and impacts to the traveling public or the environment during and after construction.
3. A complete set of plans and specifications showing the proposed revisions relative to the original Contract features and requirements. The Department requires a NH Professional Engineer's stamp and signature on any Engineering changes.
4. A complete cost analysis indicating the final estimated costs and quantities to be replaced, compared to the new costs and quantities generated by the VECP, and the cost effects of the proposed changes on operational, maintenance, and other considerations.
5. A statement specifying the date by which a Change Order adopting the VECP must be executed so as to obtain the maximum cost reduction during the remainder of the Contract.
6. A proposed revised project schedule illustrating the impacts of the VECP on the Contract completion date(s) and any other milestone dates.
7. A description of any previous use or testing of the VECP and the conditions and results therewith. If the VECP was previously submitted on another Department project, indicate the date, Contract number, and the action taken by the Department.

D. **Conditions.** VECP(s) will be considered only when all of the following conditions are met:

1. VECP(s), approved or not approved by the Department, apply only to the ongoing Contract(s) referenced in the Proposal and become the property of the Department. The VECP(s) shall contain no restrictions imposed by the Contractor on their use or disclosure. The Department has the right to use, duplicate, and disclose in whole or in part any data necessary for the utilization of the VECP. The Department retains the right to utilize any accepted VECP or part thereof on any other or subsequent projects without any obligation to the Contractor. This provision is not intended to deny rights provided by law with respect to patented materials or processes.
2. If the Department is already considering certain revisions to the Contract, or the Standard Specifications, or has approved certain changes in the Contract for general use which are subsequently incorporated in a VECP, the Department will reject the VECP and require the Contractor to proceed without any obligation to the Contractor.
3. The Contractor shall have no claim against the Department for additional costs or delays resulting from the rejection of a VECP, including but not limited to development costs, loss of anticipated profits, increased material or labor costs.
4. The Department will determine if a VECP qualifies for consideration and evaluation. It may reject any VECP that requires excessive time or costs for review, evaluation, or investigations, or which is not consistent with the Department's design policies and basic design criteria for the Project.
5. The Engineer will reject all or any portion of work performed under an approved VECP if unsatisfactory results are obtained. The Engineer will direct the removal of such rejected work and require construction to proceed under the original Contract requirements without reimbursement for any work performed or removal of that work under the VECP. Where modifications to the VECP are approved to adjust to field or other conditions, reimbursement will be limited to the total amount payable for the work at the Contract bid prices as if the work were constructed under the original Contract requirements. The rejection or limitation of reimbursement shall not constitute the basis of any claim against the Department for delay or for any other costs.
6. The VECP proposed work shall not contain experimental features but shall be proven features that have been used under similar or acceptable conditions on other projects or locations acceptable to the Department.
7. VECP(s) will not be considered if equivalent options are already provided in the Contract documents.
8. The savings generated by the VECP must be sufficient to warrant review and processing.
9. A VECP changing the type or thickness or both type and thickness of the pavement structure will not be considered. Also, any VECP that solely substitutes one material for another will not be considered.
10. Additional information needed to evaluate VECP(s), shall be provided in a timely manner. Untimely submittals of additional information will result in rejection of the VECP. Where design changes are proposed, the additional information could include results of field investigations and surveys, design computations, and field change sheets.
11. Approval or disapproval of a VECP on one Contract does not guarantee approval or disapproval on another Contract.
12. Approval of the Conceptual VECP in no way obligates the Department to approve the Full VECP.
13. No work related to a VECP shall be performed under Force Account. Agreed prices must be determined for all pay items related to the VECP before it is approved.
14. VECP(s) that only reduce or eliminate Contract pay items will not be considered.
15. If the VECP creates a significant change as defined in 104.02 that would not have otherwise resulted, the Contractor has no entitlement for additional compensation as provided for in 104.02.

- E. **Payment.** If the VECP is accepted and approved, the changes and payment will be authorized with a Change Order. Reimbursement will be made as follows:
1. The changes will be incorporated into the Contract by changes in quantities of unit bid items, or new agreed price items, as appropriate, under the Contract.
  2. The cost of the revised work as determined from the changes will be paid directly. In addition, the Department will pay the Contractor 50 percent of the savings to the Department as reflected by the difference between the cost of the revised work and the cost of the related construction required by the original Contract computed at Contract bid prices.
  3. The cost for development, design, and implementation of the VECP are not eligible for reimbursement.
  4. The Contractor may submit VECP(s) for an approved Subcontractor. Subcontractors may not submit a VECP(s) except through the Contractor.
  5. VECP payments are for direct savings or costs. Indirect saving or costs (time, user costs, etc.) will not be included in payment calculations.

## SECTION 105

### **SECTION 105 -- CONTROL OF THE WORK**

#### **105.01 Authority of the Engineer.**

The Engineer will decide all questions regarding the quality and acceptability of materials furnished, work performed, the rate of progress of the Work, the interpretation of the Contract, and the acceptable fulfillment of the Contract by the Contractor.

The Engineer will suspend the Work, wholly or in part, for such periods as may be necessary due to the Contractor's failure to correct conditions unsafe for the Project personnel or general public, or carry out provisions of the Contract, or carry out orders of the Engineer.

Work may also be wholly or partially suspended for periods necessary due to existing or forecasted unsuitable weather, or for conditions considered unsuitable for the prosecution of the Work such as hazardous materials, directives of the New Hampshire Department of Environmental Services, Air Resources Division, implementing emergency episode procedures, or any other condition or reason deemed to be in the Department's interest. For suspensions due to these causes, refer to [104.02.D](#) Suspensions of Work Ordered by the Engineer.

#### **105.02 Plans and Working Drawings.**

Plans shall be supplemented by Contractor-prepared working drawings as found necessary to control the Work and its prosecution. Working drawings consisting of details that are not included in the Plans but required for the Work shall be furnished to the Department. Manufacturer's Engineering data for prefabricated material, including that for falsework and forms, shall be furnished with each set of working drawings.

The Contractor shall submit to the Engineer for approval or documentation the required Working Drawings. Copies of any calculations required to prepare the Working Drawings shall be furnished with the drawings. The Working Drawings shall be furnished well in advance of the Work to allow the Engineer time to review or distribute the working drawings. Any work done or materials ordered for work shown on the working drawings prior to approval or distribution of the drawings shall be at the Contractor's risk.

**Working Drawings for Approval.** Working drawings submitted for approval shall include, but not be limited to; the following:

- shop fabrication drawings (3 sets),
- bending diagrams when required for reinforcing steel (3 sets),
- Storm Water Pollution Prevention Plan (4 sets),
- Detour Plans\*, Contractor Designed (3 sets), or any other working drawings where approval is required by the Contract.

\*The Contractor may propose detours not shown on the Plans. The Contractor shall submit proposed detour plans in triplicate for approval, which shall show the proposed location, layout, grade, typical cross section, protective fixtures and signing.

The Contractor shall submit the required sets of working drawings for approval to the Engineer for review. The Engineer will be allowed up to fifteen (15) working days for review of each submission. If the Engineer has not responded to the Contractor after fifteen working days, the Contractor shall contact the Engineer to inquire about the status of the submittal. If the Engineer requires more time for review and the Contractor believes that it is entitled to an extension of the Contract Time due to this additional review time, the Contractor shall request a time extension and proceed as required by [104.02](#) and [108.07](#). A delay caused by additional time required for review is a Noncompensable Delay. Each resubmission including requests for additional information will be treated as a new submission and may require up to fifteen (15) working days for review by the Engineer. The fifteen working days will begin upon arrival at the Bureau of Construction's main office. The review will be considered complete when the date and status has been placed on the submittal. One set of the drawings will be returned to the Contractor marked approved or with corrections to be made. After approval has been given, the Contractor shall supply the Engineer with six sets, or seven sets if a design consultant is involved in the project, of the revised Working Drawings.

**Working Drawings for Documentation.** Working drawings submitted for documentation shall include, but are not limited to the following, unless otherwise noted in the Contract:

- Progress Schedules,
- temporary bridge plans,
- removal of existing bridge structure plans,
- cofferdam plans,
- water diversion structure plans,
- plans of precast elements to be designed by the Contractor,
- erection plans,
- temporary support systems,

- falsework plans,
- scaffolding plans and bridge analysis,
- sign structure plans,
- traffic signal poles and mast arm plans, or
- any other working drawings for documentation required by the Contract.

Working Drawings for documentation, excluding the Progress Schedule, shall be prepared, stamped, and signed by a Licensed Professional Engineer licensed in the State of New Hampshire. The Contractor shall submit five sets of working drawings for documentation to the Engineer for distribution a minimum of fifteen working days prior to commencing work shown on the working drawings. Working drawings for documentation will be placed in the Department's project files as a record of the Contractor's method of operation. The Department reserves the right to return the working drawings for revisions based on the content and non-conformance with the Plans and Specifications.

The Contract Amount will include the cost of furnishing all Working Drawings.

The Engineer's receipt of documentation or distribution of the Contractor's Working Drawings does not relieve the Contractor from responsibility under the Contract for errors in dimensions, incorrect fabrication and erection processes, design requirements specified or successful completion of the Work.

#### **105.03 Conformity with Plans and Specifications.**

Work performed and materials furnished shall be uniform in character and meet the Contract dimensions and material requirements according to tolerances specified in the Contract. If tolerances are specified, deviations beyond the specified limits will be unacceptable. When tolerance limits are not specified, and only single dimensions are indicated, such dimensions are to be regarded as nominal dimensions.

If the materials furnished, work performed, or the finished product does not conform with the Contract, but adequately addresses the design purpose, the Engineer will determine the conditions under which the Work will be accepted and allowed to remain in place unless there are other provisions in the Contract that provide for this determination. Where this determination is made by the Engineer rather than Contract provisions, the Engineer will document the basis of acceptance by Contract Revision. The revision will provide for an appropriate adjustment in the Contract Amount for such work or materials as necessary to support the Engineer's determination.

If the materials, work performed, or the finished product do not conform with the Contract and results in an unsatisfactory or unacceptable product, the work or materials shall be removed and replaced or otherwise corrected to the satisfaction of the Engineer at the Contractor's expense.

If there are provisions in the Contract (QC/QA provisions) for the acceptance of material or work that is not in full compliance with the minimum requirements stated, the use of pay adjustment factors reflecting the payments to be made for the Work or Materials will be included in the applicable Subsection concerning method of measurement and basis of payment or in a separate Subsection.

#### **105.04 Coordination of Plans, Specifications, Supplemental Specifications, and Special Provisions.**

The Specifications, Supplemental Specifications, Plans, Special Provisions, other special Contract requirements and all supplemental documents are essential parts of the Contract and a requirement occurring in one is as binding as though occurring in all. They are intended to be complementary and to describe and provide for a complete Contract. In case of discrepancy between these Contract documents, calculated dimensions, unless obviously incorrect, will govern over scaled dimensions and the parts of the Contract will prevail in the following descending order:

- Special Contract Requirements \*
- Special Provisions
- Plans
- Supplemental Specifications
- Standard Specifications
- Standard Details
- Standard Plans

\* Including, but not limited to, Prosecution of Work, Traffic Control Plan and Special Attentions in the mentioned descending order.

The Contractor shall not take advantage of any apparent error or omission in the Contract. If an error or omission is discovered, the Engineer shall be notified in accordance with [104.02](#) so corrections and interpretations necessary to fulfill the intent of the Contract can be made.

## SECTION 105

When general reference is made on bridge plans to “AASHTO Specifications,” it shall refer to the AASHTO publication entitled “LRFD Bridge Design Specifications.” The reference shall be to the current edition of such specifications, or latest revision adopted thereof and in effect on the date of invitation for bids.

### 105.05 Cooperation by the Contractor.

With the exception of the Standard Specifications and Standard Plans, the Contractor will be supplied with a minimum of two sets of the Contract. The Contractor shall keep one set available on the Project at all times.

The Contractor shall give the Work the constant attention necessary to facilitate progress, and shall cooperate with the Engineer, Department inspectors, and other Contractors.

The Contractor shall have on the project site, at all times when the Work is being performed, a competent English-speaking Superintendent or other authorized representative in responsible charge of the Work. Said individual shall be thoroughly qualified and fully authorized to execute the responsibilities of a Superintendent as described herein. The individual shall not be an owner, employee, or have any affiliation with any firm which is acting as a Subcontractor on the project. The Superintendent shall receive instructions from the Engineer or authorized representatives, be authorized to act for the Contractor as agent on the Work, and have full authority to execute orders or directions of the Engineer without delay.

The Contractor shall promptly supply, irrespective of the amount of work sublet, the necessary Materials, equipment, tools, labor, and incidental items to complete the Contract.

Should the Contractor, or any of its duly authorized representatives, fail to cooperate to the extent that the integrity of the Work is compromised, or the safe prosecution of the Work is jeopardized, the Engineer may immediately suspend all Work. Any unsafe conditions will be corrected by the Contractor and the uncooperative person or persons shall be removed from the Project before the resumption of the Work. Failure to rectify the situation may result in the termination of the Contract in accordance with the provisions of 108.11.

### 105.06 Cooperation with Utilities.

Utility items that are to be relocated or adjusted by the utility, others, or the Contractor will be shown in the Contract.

All utility facilities and appurtenances within the construction limits will be shown on the Plans and relocated or adjusted at the utility owner's expense, unless otherwise specified. The locations of these utilities are as provided by the utility owners and may not be exact, particularly with regard to underground installations. Contractor work procedures are to account for the inaccuracy inherent in the representation of their location. Attention is directed to the possible existence of underground facilities not known to the Department.

New Hampshire State Law, RSA 374:48-56, requires that anyone who excavates in a public way or utility easement must notify the utility damage prevention system, DIG-SAFE, at least 72 hours prior to starting work.

The Contractor shall be responsible to notify the DIG-SAFE Call Center (Tel. No. 1-888-DIG SAFE (1-888-344-7233)) at least 72 hours in advance of starting any excavation or erecting permanent construction signing. Saturdays, Sundays, and legal holidays are not to be included in the computation of the required 72-hour notice.

The Contractor shall provide the Engineer with the date, time, numbers assigned, and the name of the person answering the call at the DIG-SAFE Center.

Notice of intent to excavate cannot be made more than 30 days prior to actual work. All utility facilities within the proposed Work, including advance construction sign locations, should be identified and marked prior to construction. Suspension of the Work for more than 30 days at any time will require re-notification of the DIG-SAFE Center to ensure validity of markings and to protect interim utility construction.

The Contractor shall provide sufficient lead time to allow for Contractor layout of advance permanent construction signs and excavation areas prior to the start of the 72-hour period required by DIG-SAFE.

The Contractor shall additionally notify municipal and privately-owned utilities to identify, locate, and mark their facilities separately from those to be located through the DIG-SAFE system.

Once located and marked, the Contractor shall maintain all utility markings and provide access to any and all installations to permit repairs and maintenance of service as needed.

The Contractor shall cooperate with utility owners in the removal and rearrangement of underground or overhead utility facilities to minimize interruption to utility services and duplication of work by the utility owners.

Facilities or appurtenances that are to remain in place during construction shall be accounted for and protected by the Contractor's work procedures. The fact that an underground facility is not shown on the plans shall not relieve the Contractor of its responsibility under this Section. At points where the Contractor's operations are adjacent to properties of railway, telecommunications, gas, and electric power companies, and other utilities, or are adjacent to other property where damage might result in considerable expense, loss, or inconvenience, Work shall not commence until all arrangements necessary for the protection thereof have been made.

The Department will notify all utility companies, pipe line owners, or other parties affected by the Work and have all necessary adjustments of the public or private utility fixtures and appurtenances within or adjacent to the construction limits made as soon as possible.

In the event utility services are interrupted as a result of damage within the Limits of Construction, the Contractor shall notify the appropriate utility authorities and cooperate with them until service has been restored. Work shall not commence around fire hydrants until provisions for continued service have been made and approved by the local fire authority.

Repairs to damaged utilities caused by carelessness or omissions on the part of the Contractor shall be corrected at the Contractor's expense. The damaged facilities shall be restored to a condition similar or equal to that existing before the damage occurred.

It is understood and agreed that the Contractor has considered in its bid all of the permanent and temporary utility facilities in their present or relocated positions as shown on the Plans and as evident on the site, and that no compensation will be allowed for any delays, inconvenience, or damage sustained due to any interference from such utility facilities or the operation of moving them. Full compensation for furnishing all labor, materials, tools, equipment, and incidentals, and for doing all the work involved in protecting or repairing property as specified above shall be considered as included in the prices paid for the various Contract items of work and no compensation beyond the amounts provided for in the Contract will be allowed therefore.

Should the Contractor desire to have any rearrangement made of any utility facility, or other improvement, for the Contractor's convenience in order to facilitate construction operations, which rearrangement is in addition to or different from, the rearrangements indicated in the Contract, the Contractor shall make whatever arrangements are necessary with the owners of such utility or other non-highway facility for such rearrangement and bear all related expenses.

If utility facilities or appurtenances are found that are not noted in the Contract, the Engineer will determine whether adjustment or relocation of the utility is necessary to accommodate construction and proceed to make necessary arrangements with the utility owner or the Contractor if the work necessary is not otherwise specified. If the Contractor believes that it is entitled to compensation or a time extension based on the Engineer's determination or arrangements, then the Contractor shall proceed in accordance with Section 104.02, including providing notice as required by 104.02.G.

#### **105.07 Cooperation Between Contractors.**

The Department reserves the right at any time to Contract for and perform other or additional work on or near the Work covered by the Contract.

When separate Contracts are let within the limits of any one project or on adjacent projects, each Contractor shall conduct the Work without interfering or hindering the progress or completion of the work by other Contractors. Contractors working on the same project or adjacent projects shall cooperate with each other in a manner to serve the best interest of the State. In case of any unavoidable interference, the Engineer will determine priorities.

Each Contractor involved shall assume all liability, financial or otherwise, in connection with the Contract and shall protect and save harmless the Department from damages or claims that may arise because of inconvenience, delays, or loss experienced because of the presence and operations of other Contractors working within the limits of the same project.

The Contractor shall arrange the Work and place and dispose of materials being used without interfering with operations of the other Contractors within the limits of the same project or on adjacent projects. The Work shall be coordinated with the work and sequence of other Contractors.

#### **105.08 Construction Stakes, Lines, and Grades.**

The Engineer will set stakes and furnish data necessary to establish the line and grade of the finished surface, the lines and grades of all waterways and structures, and such other points and bench marks as are necessary to lay out the Work correctly. This "initial" layout will include control points, bench marks, line ties, and leveled side stakes as required for grade control and reproduction of construction center line. It will also include bridge targets, line ties, and reference stakes for bridges, retaining walls, and full span overhead sign structures.

The Engineer will take cross sections or topographic cross sections as required to complete measurement of quantities as provided in 109.01. This work includes reference points, base lines, stakes, bench marks, and cross sections for borrow pits where applicable.

The Engineer will stake and reference all required Rights-of-Way, easement limits, and bounds.

The Contractor shall cooperate in the setting and shall be responsible for the preservation of all "initial" layout stakes and marks, and if any of the construction stakes or marks have been carelessly or willfully destroyed or disturbed by the Contractor, the cost of replacing them will be charged against the Contractor and will be deducted from the payment for the work. Damaged or destroyed points, bench marks, or stakes or any reference points damaged or made inaccessible by the progress of the construction shall be replaced or transferred by the Contractor, subject to verification by the Engineer. Replacement of all "initial" layout (with the exception of side stakes or drainage reference stakes) shall be performed by or under the direction of a Licensed Land Surveyor.

The Contractor shall perform all necessary layout work not specified above in order to construct all elements of the Project as shown on the Plans and specified in the Contract. This work shall include, but shall not be limited to, stakeout necessary for re-establishment of line and grade as earthwork operations progress, stakeout, layout, and elevations as required for structures, forms, pile layouts, and paving. Prior to paving, the Contractor shall perform all work necessary to set the blue top stakes for fine grading.

## SECTION 105

The Contractor shall perform all required layout work with competent, qualified personnel to meet minimum Third-order, Class I survey accuracy and procedures (Horizontal: 1 in 10,000, Vertical: 0.05 ft. X  $\sqrt{\text{distance in miles}}$ ). Any error, apparent discrepancy, or absence of data in the Department's "initial" layout shall be referred to the Engineer in writing for correction or interpretation. The Contractor is solely responsible for the accuracy of the Work. All computations necessary to establish the exact position of the Work from control points shall be made and preserved by the Contractor. All computations, notes, and other records necessary to accomplish the Work shall be neatly made. Such computations, notes, and other records shall be made available to the Engineer upon request.

The Engineer may check all or any portion of the layout, stake-out, or notes made by the Contractor. Any necessary correction to the Work shall be made immediately by the Contractor. Such checking by the Engineer will not relieve the Contractor of any responsibilities for the accuracy, or completeness of the work. Rechecking, by the Engineer, of any portion of the Contractor's layout, stakeout, or notes will be charged against the Contractor and will be deducted from the payment for the work.

No entitlement to additional compensation will be considered because of alleged inaccuracies unless the Contractor notifies the Engineer in accordance with 104.02.

**105.08.1** No work to establish line and grade will be provided by the Department on resurfacing areas.

**105.08.2** On recycling or reclamation areas the Department will not establish line and grade. The Contractor shall supply all material and perform all work to determine the existing line and grade and cross-slopes prior to recycling or reclamation work and establish finished line, grade and cross-slopes. Original plans and computed cross-slopes at curves will be provided by the Engineer.

The Contractor shall determine and lay out, with survey instruments, the finished alignment at 50-foot intervals including all horizontal curve points (PC, PI, PT, spiral to curve (SC), spiral to tangent (ST), and POC as required). The Contractor shall lay out and set all grade control necessary to complete the final grading.

### **105.09 Authority and Duties of Representatives of the Engineer.**

As the direct representative of the Engineer, the Contract Administrator has immediate charge of the Engineering details of each construction project and is responsible for the administration and satisfactory completion of the Project. The Engineer may appoint such representatives as desired. All representatives have authority to give directions pertaining to the Work or to the safety and convenience of the public, to approve or reject materials, to suspend any work that is being improperly or unsafely performed, to make measurements of quantities, to keep records of costs, and otherwise represent the Engineer. The Contractor may, however, appeal their decision to the Engineer, but any work done pending resolution is at the Contractor's own risk.

Except as permitted and instructed by the Engineer, the representatives are not authorized to revoke, alter, enlarge, relax, or release any requirements of the Contract, nor to issue instructions contrary to the Contract. They are not authorized to act in a supervisory capacity for the Contractor or to interfere with the management of the Work by the Contractor. Any advice that the assistants or representatives of the Engineer may give the Contractor shall not be construed as binding the Engineer or the Department in any way, nor releasing the Contractor from the fulfillment of the terms of the Contract.

All transactions between the Contractor and the representatives of the Engineer that are subject to protest or where payments are involved shall be made in writing.

### **105.10 Inspection of Work.**

Materials and each part or detail of the Work shall be subject to inspection by the Engineer. The Engineer shall be allowed and provided safe access to all parts of the Work and shall be furnished with information and assistance by the Contractor as required to make a complete and detailed inspection.

The Contractor shall remove or uncover such portions of the finished Work if directed by the Engineer. After examination, the Contractor shall restore the Work to the standard required by the Contract. Should the Work prove acceptable, the uncovering, removing, and the replacing of the covering or making good of the parts removed will be paid as provided for in 109.04. Should the Work prove unacceptable, the uncovering, removing, and replacing of the covering or making good the parts removed, shall be at the Contractor's expense.

Work done or materials used without supervision or inspection by an authorized Department representative may be ordered removed and replaced at the Contractor's expense, unless the Department representative failed to inspect the Work after having been given reasonable notice in writing that the Work was to be performed.

When any unit of government or political subdivision, utility, or any corporation is to accept or pay for a portion of the Contract cost or has an interest in the Work for other reasons, its representatives shall have the right to inspect the Work. The inspection by these agencies does not make them a party to the Contract nor will it change the rights of the Contract parties.

### **105.11 Removal of Unacceptable and Unauthorized Work.**

Work that does not conform to the Contract requirements will be considered unacceptable, unless accepted under the provisions of 105.03.



Unacceptable Work, whether the result of poor workmanship, use of defective or unapproved materials, damage through carelessness, or any other cause found to exist before Acceptance of the Work, shall be removed and replaced at the Contractor's expense.

Work done contrary to instructions received from the Engineer, or beyond the Limits of Construction except as specified, without permission of the Engineer is considered unauthorized and will not be considered for payment. Corrective work meeting the Contract provisions shall be at the expense of the Contractor. If the Contractor fails to proceed promptly or provide written notice of intent to proceed, with the performance of corrective work ordered by the Engineer, after 48 hours' notice, the Engineer has the authority under this Subsection to have the unacceptable work removed and remedied by others and to deduct the cost of the work by others from the money due the Contractor.

#### 105.12 Construction Zone(s).

Pursuant to the authority granted the Commissioner of Transportation under RSA 266:20, construction zones are established in accordance with the following:

A construction zone will be established for any highway or related part thereof designated for construction, reconstruction, or repair by the Department.

For the purpose of definition, the limits of the Construction Zone(s) will be the beginning and end of the designated Project, or portions thereof, including approaches and connections as denoted within the Contract Special Provisions. The Construction Zone will become effective at the time the construction signs are erected and will remain in force until the signs are removed.

Use of construction and maintenance equipment within limits of Construction Zone(s) will be as allowed in 105.13.

Extension of the Construction Zone outside the limits noted above may only be granted upon written request and issuance of a Construction Zone extension permit. The permit will expire upon removal of the construction signs, as noted above, or by letter from the Engineer, if conditions warrant an earlier suspension. (Extensions of the Construction Zone will not be permitted on the Interstate System due to the vehicle weight limitations of Federal law 23 USC 127.)

#### 105.13 Load Restrictions.

- A. **Outside Construction Zone Limits.** The Contractor's hauling and construction equipment shall not exceed the legal or posted gross loads for any bridge or highway being used outside a Construction Zone as referenced in 105.12.
- B. **Within Construction Zone Limits.**
  1. **On New or Existing Pavements.** Trucks or equipment hauling loads in excess of legal loads shall be certified per RSA 266:18-d to the weight limitations of RSA 266:18-b. Without written authorization from the Engineer, heavy "off-road" hauling equipment shall not be allowed on pavement that is (or will be subject to use as) a public highway. When such highways are in use by the Contractor and the public, authorization will be contingent upon an approved clear zone or approved physical barrier between construction equipment and the public.
  2. **On New or Existing Bridges.** Gross loads in excess of the legal gross loads will not be allowed unless authorized in writing by the Engineer. Requests for such authorization shall be in writing and shall indicate the length of the vehicle, the type and amount of gross load with the location and the load distribution to each axle. Authorization will specify the maximum speed and location of loads relative to the centerline of the bridge.
 

New concrete bridge decks shall be closed to traffic, including the Contractor's trucks and equipment, for a period of time as specified in 520.3.11.2 with the following exception:

Lightweight vehicular loads weighing less than 6,000 lb. GVW will be allowed after the concrete test cylinders have attained 80 percent of the minimum compressive strength of the specified deck concrete. Heavier loads may be permitted upon written request and authorization in the same manner as for gross loads in excess of the legal gross loads.
- C. **General.** The Contractor shall not operate equipment of such type, weight, or so loaded as to cause any damage to structures, to the roadway, or to any other work. Hauling of materials over the pavement base course or surface course under construction shall be subject to approval by the Engineer. The Contractor shall be responsible for all damage done by the Contractor's equipment. No permit or approval will relieve the Contractor of liability for damages.

It is specifically called to the Contractor's attention that highways not on the State system are the property of the municipality within which they are located. Such highways are maintained and regulated by the municipal authority. Prior to subjecting such highways to construction loads and equipment, the Contractor shall secure the written consent of the proper municipal authority. During the use of these highways, the Contractor shall maintain them in a condition satisfactory to the authorities and safe for the traveling public. Damage attributed to hauling operations shall be repaired by the Contractor to the satisfaction of the proper authorities.

## SECTION 105

- D. **Vehicle Weight.** The Engineer will monitor highway vehicles for compliance with the vehicle's registered weight. If the Engineer discovers a violation, it will be brought to the attention of the Contractor. If a prompt resolution to the problem is not achieved, the State will not pay for the portion of any load delivered to the project in excess of the load within that vehicle's registered gross vehicle weight and any applicable tolerances. The truck will be required to discharge its entire load and payment will be made only for the portion within that vehicles' registered gross vehicle weight at the Item Bid Price (or equivalent Item Bid Price for lump sum items).

### 105.14 Maintenance of Work During Construction.

The Contractor shall maintain the Project work site in a satisfactory condition until the project is accepted. This maintenance shall consist of continuous and effective work prosecuted day-by-day.

The Contractor shall take every reasonable precaution against spillage of construction materials on existing highways and bridges. The Contractor's attention is called to "Spillage of Material" under 107.01. If spillage does occur, the Contractor shall remove such spillage immediately after its occurrence. Particular care shall be taken to see that bridge deck and approach surfaces are kept as smooth as possible and free from all stone, gravel, or any other material that would increase impact or would damage the finished bridge or approach surfaces.

Maintenance shall include, but not be limited to, mowing grass, and cleaning and maintenance of erosion control and drainage structures.

The Engineer will notify the Contractor of failure to meet these provisions. If unsatisfactory maintenance is not remedied within 24 hours after receipt of the notice, the Engineer will proceed to maintain the Project. The Contractor shall pay the entire cost of this maintenance.

Once the work involves the placement of material on, or the use of a previously constructed subgrade, base course, pavement, or structure, the Contractor shall maintain the previously constructed work.

All cost of maintenance work during construction and before Acceptance shall be subsidiary to the bid price for other items of work except as outlined in 104.03, 619.3.1.9 and 619.5.1.8.

### 105.15 Opening Sections of Project to Traffic.

The Engineer may order certain sections of the Project to be opened to traffic before Completion or Acceptance. Opening these sections shall not constitute acceptance of the Work or a waiver of any Contract provisions.

If the Contractor is late in completing features of the Work according to the Contract or Progress Schedule, the Engineer will give written notification establishing a time period for completing these features. If the Contractor fails to complete the Work ordered, or make a reasonable effort to complete the Work according to the written notification, the Engineer may order all or a portion of the Project opened to traffic. The Contractor shall not be relieved of liability or responsibility for maintaining the Work and shall conduct the remaining construction operations with minimum interference to traffic and without compensation for the added cost of the work.

### 105.16 Furnishing Right-of-Way.

The Department will acquire all necessary property rights in advance of construction. Any exceptions will be indicated in the Contract.

Material production facilities may be permitted on state-owned property for the production of Materials needed for particular Department projects. Under no circumstances shall state-owned property be used by the Contractor for any business enterprise unless a request is received by the Commissioner and processed in accordance with RSA 4:40, as amended.

### 105.17 Project Acceptance.

Acceptance will not occur until Project Completion as defined in Section 101. However, at the request of the Contractor and at the discretion of the Engineer, the Contract Time may be stopped without all the required documents, certificates, or proofs of compliance. It must be established that the Contractor could not reasonably or in good faith provide some of the required compliance documentation before incorporating in the Work the Material requiring compliance documentation.

When the Contract Time is stopped, the Contractor is to expeditiously provide the exempted documents, certificates, or proofs of compliance. Acceptance and payment will not be made until all documents, certificates, or proofs of compliance have been executed and delivered to the Engineer.

- A. **Partial Project Acceptance.** When a portion of the Project, such as a structure, interchange, or section of road or pavement is substantially completed, the Contractor may request final inspection of that portion. If the portion has been completed in accordance with the Contract except:
- (1) the removal of temporary by-passes or other temporary structures that have been erected for the convenience of the traveling public and that do not interfere with the normal use of the roadway,
  - (2) the satisfactory cover and mature growth of grass in seeded areas, or

- (3) the clean-up of pits, the Engineer may accept the portion as completed and relieve the Contractor from the cost of future maintenance of the designated portion of the Project. Work subsequently required by the Engineer on the accepted portion shall be paid as provided for in 109.04. The decision to make partial acceptance of a portion of the Project is solely at the discretion of the Engineer. Partial acceptance does not void or alter any of the terms of the Contract.

**B. Project Acceptance.** Upon receiving notice from the Contractor of Project Completion, the Engineer will make an inspection. If the Work required by the Contract is found to be complete, the inspection shall constitute the final inspection and the Engineer will notify the Contractor in writing to acknowledge completion of the work.

If unsatisfactory Work is noted, the Engineer will give the Contractor the necessary instructions for correction of such Work, and the Contractor shall immediately comply with and execute such instructions. Upon correction of the Work, another inspection will be made that shall constitute the final inspection. If the Work has been satisfactorily completed, the Engineer will provide Acceptance of the Work by notifying the Contractor in writing of the date of final inspection and Acceptance.

#### **105.18 Claims.**

The Contractor is not entitled to file a claim in accordance with this subsection 105.18 unless the Contractor has first provided timely and complete notice and fulfilled the requirements of 104.02.G. Within 20 workdays of the date of the Engineer's final written response or the date that 104.02.G.4 specifies that such a response should have been received, if the Contractor disagrees with the Engineer's final written response or the response is untimely, the Contractor shall provide written notice to the Engineer of its intent to file a claim seeking compensation or a time extension for that portion of the Engineer's response with which the Contractor disagrees. Failure of the Contractor to provide timely notice of its intent to file a claim will constitute a waiver of the Contractor's entitlement to compensation or a time extension for any claim for which notice was not provided. Failure of the Contractor to continue to maintain records as required by 104.02.G.2 will also constitute a waiver of the Contractor's entitlement to compensation or a time extension for those aspects of the Engineer's final written response with which the Contractor disagrees.

If the Contractor does not provide the Engineer with documentation as described in 104.02 and 109.04, the Contractor waives entitlement to compensation and/or time adjustment under 109.04 and 108.07. Notice by the Contractor, and the fact that the Engineer has kept account of the costs shall not be construed as substantiating the validity of the claim. Compensation shall be determined in accordance with 109.04 and time extensions shall be determined in accordance with 108.07 will be made to the Contract if the claim is found by the Engineer to have merit. Failure to submit a claim prior to final payment on the Contract shall constitute a waiver of entitlement to compensation and/or time adjustment.

##### **A. Claim Submittals.**

Claim submittals shall be in sufficient detail to enable the Engineer to determine the basis for entitlement and the compensation and time extension due, if any. At a minimum, the Contractor's claim shall include the following pertinent data arranged in a logical sequence:

1. Detailed factual statement of the claim providing all dates, locations, and work affected by the claim.
2. The date or dates conditions resulting in the claim became evident and events resulting in the claim occurred.
3. The name, title, and work assignment of each Department employee knowledgeable of the facts that gave rise to such claim.
4. The name, title, and work assignment of each Contractor employee knowledgeable of the facts that gave rise to such claim.
5. The specific provisions of the Contract that support the claim, and a statement as to why the provisions support the claim.
6. Schedules and updates prepared in accordance with 108.03, if delays or a request for a time extension are relevant to the disputed issue;
7. The identification of any relevant documents, and the substance of any significant oral communications relating to the claim.
8. A statement as to whether the compensation or extension of time being claimed is based on the provisions of the Contract or an alleged breach of Contract.
9. If extension of time is also sought, the specific days for which it is sought, and the basis for such claim as determined by an analysis of the construction schedules.
10. The amount of compensation sought with supporting documentation of the amount in accordance with 109.04 of that amount.

The Contractor's failure to provide this information will constitute a waiver of the Contractor's entitlement to compensation or a time extension for the claim.

## SECTION 105

### B. Required Certification Of Claims.

In addition to the information required in 105.18.A, the Contractor's Claim must be accompanied by the following signed certification. The Contractor's failure to provide this certification will constitute a waiver of the Contractor's entitlement to compensation or a time extension for the claim:

#### CERTIFICATE OF CLAIM

*The undersigned is duly authorized to certify the enclosed documentation on behalf of (the Contractor).*

*(The Contractor) certifies that the documentation is submitted in good faith, that the information provided is accurate and complete to the best of (the Contractor's) knowledge and belief, and that the compensation and time extension requested accurately reflects the Contract Revision for which (the Contractor) believes the department is responsible.*

Name and Title	
Company	
Date	Signature
Notarized:	

### A. Review of Claims.

The Engineer will provide written acknowledgment of receipt of the claim within 10 days to the Contractor. During the claim review process by the Engineer, the Contractor shall provide the Engineer access to and, if requested, copies of the following documents. The Contractor's failure to provide this access or copies as requested will constitute a waiver of the Contractor's entitlement to compensation or a time extension for the claim:

1. Daily time sheets and foreman's daily reports.
2. Union agreements, if any.
3. Insurance, welfare, and benefits records.
4. Payroll register.
5. Earnings records.
6. Payroll tax returns.
7. Material invoices, purchase orders, and material and supply acquisition Contracts.
8. Material cost distribution worksheets.
9. Equipment records (list of company equipment, rates, etc.)
10. Vendor rental agreements.
11. Subcontractor payment certificates and invoices.
12. Canceled checks (payroll and vendors).
13. Job cost report.
14. Job payroll ledger.
15. General ledger, general journal, (if used) and all subsidiary ledgers and journals together with all supporting documentation pertinent to entries made in these ledgers and journals.
16. Cash disbursement journal.
17. Financial statement for all years reflecting the operations on this Project.
18. Income tax returns whether such records are maintained by the company involved, its accountant, or others.
19. All documents that reflect the Contractor's actual profit and overhead during the time the Project was being performed and for each of the five years prior to the commencement of this Project.
20. All documents related to the preparation of the Contractor's bid, including the final calculations on which the bid was based.
21. Worksheets used to prepare the claim, establishing the cost components for items of the claim including, but not limited to, labor, benefits and insurance, materials, equipment, Subcontractors, and all documents that establish the time periods, individuals involved, the hours and the rates for the individuals.

**105.19 Resolution of Claims and Disputes.**

- A. After review of the claim, if the Engineer concludes that the Contractor has established entitlement to compensation or a time extension, the Engineer will determine compensation in accordance with 109.04, and time extensions in accordance with 108.07.
- B. Within 30 calendar days date of the Engineer's decision, if the Contractor does not agree with the Engineer's decision, the Contractor may appeal the matter to the Commissioner in accordance with the Department's statutory appeals procedures. The statutory appeals procedures are available from the Office of Hearings and Rules at the Department. Nothing in this subsection shall be construed as establishing any claim contrary to the terms of 104.02. Compensation shall be in accordance with 109.04 with time extensions as provided for in 108.07 will be made to the Contract if the claim is found by the Commissioner to have merit.

**SECTION 106 -- CONTROL OF MATERIAL****106.01 Source of Supply and Quality Requirements.**

All materials used shall meet the requirements of the Contract. In order to expedite the inspection and testing of materials, the Contractor shall notify the Engineer of the proposed sources of materials to be used in the Work before delivery. The Engineer has the option of conditionally approving materials at the supply source. Any material incorporated into the Work that subsequently fails to meet the Contract requirements shall be corrected to the satisfaction of the Engineer or removed. All materials used in the Work shall be new unless otherwise specifically prescribed in the Contract.

**106.02 Local Material Sources.**

Possible sources of local materials may be indicated on the Plans and described in the Proposal. Since it is not feasible to determine from natural deposit sampling the acceptable limits for an entire deposit, variations in materials quality within the deposits are to be considered usual and to be expected. The Engineer may order procurement of material from any portion of a deposit and will reject portions of the deposit as unacceptable if the material fails to meet specification requirements.

The Department may make available the right to take materials from designated sources described in the Contract together with the right to use the property as specified, for plant site, stockpiles, and hauling roads. If this procedure has been chosen by the Department, the Contract will define the acquisitions or rights provided.

If material is used from other than Contract designated sources, the Contractor shall comply with the regulations of RSA 155-E, acquire the necessary rights to take materials from the sources, and pay all related costs. The Contractor shall submit to the Department a copy of the permit for excavation (required under RSA 155-E) showing that the excavation site has been permitted by the Regulator prior to removing any material from that site.

Where practicable, pits, quarry sites, and access roads shall be located so that they will not be visible from any highway. Pits and quarries shall be excavated so that water does not collect and stand on the site during the work. Following the completion of the work, pits and quarries shall be left in a neat and presentable condition.

For Contractor-acquired rights to excavation sites, upon completion of the work, the Contractor shall ensure that the necessary grading and reclamation work as required per RSA 155-E is done. Acceptance of the project will not be made until a written release from the property owner indicates that the agreement conditions with the Contractor have been satisfied.

The Contractor's attention is directed to RSA 482-A:3, the requirements of which must be fulfilled if the excavation site involves excavation or dredging of wetlands and to the provisions of RSA 483-B and RSA 485-A:17, if the excavation site involves dredging or mining on the border of the surface waters of the State or will significantly alter the characteristic natural runoff or create an unnatural runoff.

The Contractor's attention is also directed to Executive Orders 11988 and 11990 if the excavation site will affect floodplains or wetlands.

The Contractor's attention is also directed to Section 10 of the Rivers and Harbors Act of 1899 and Sections 401 and 404 of the Clean Water Act, for which compliance may require a permit for work in or affecting "navigable waters of the U.S.," or material placed in "waters of the U.S.," including wetlands.

The Contractor is cautioned of the potential to encounter contaminated soils within the excavation area and, if encountered, shall avoid incorporating contaminated soils within the limits of the project. Furthermore, the Contractor shall complete a Historic and Archaeological Resources certification in accordance with the Contract.

A [Pit Agreement Form](#) shall be completed and submitted for each excavation site that the Contractor intends to open in accordance with RSA 155-E:2,IV. The Pit Agreement form may be obtained online at the [Department's Website](#) or from the Engineer.

**106.03 Samples, Tests, Cited Specifications.**

Materials will be inspected, tested, and approved by the Engineer or accepted by a Certificate of Compliance from the Contractor as specified in [106.04](#) unless otherwise specified in the Special Provisions for QC/QA items. The Contractor shall not rely on the results of Department testing being available for Process Quality Control. Materials found to be unacceptable and unauthorized will not be paid for and, if directed by the Engineer, shall be removed at the Contractor's expense.

Unless otherwise designated, materials tests will be performed by and at the expense of the Department using the standard test methods of the Department, AASHTO, ASTM, or FSS (unless other standard methods are designated) that are in effect on the date of advertisement for Proposals, except that the Engineer reserves the right to make use of any information or method of testing to determine that the material meets the Contract requirements. If there is a difference in the test methods, the order of precedence for the test procedures used will be as follows:

1. The Department's Standard Materials Test Methods
2. AASHTO
3. ASTM
4. FSS

Samples for testing purposes shall be furnished by the Contractor at no cost to the Department. The sampling and sample splitting of materials tested by the Department will be performed or observed by a qualified representative of the Department.

The Department may retest and reject unacceptable materials previously tested and conditionally accepted at the source of supply. Materials to be used are subject to inspection, testing, or rejection prior to Acceptance. Copies of any tests will be furnished to the Contractor's representative upon request.

Random samples of materials or completed work may be taken as checks on the control sampling and testing to determine reasonable compliance with the Specifications. Such sampling will be at any time prior to Acceptance of the Work, either while any phase of the Work is in progress or after it has been completed. The extent and locations of such random sampling will be as designated by the Engineer.

In all AASHTO or ASTM specifications, the sections entitled "Inspection" shall be amended to provide that tests of materials may be made in any Laboratory as defined in [Section 101](#).

All sieves shall conform to the requirements of the AASHTO M 92, and shall be square hole wire cloth sieves.

When sampling and testing of seeds is required, sampling and testing methods shall be as prescribed in the Rules and Regulations established in accordance with RSA 433.

Equipment required to be supplied by the Contractor for Department use under the specifications shall be calibrated yearly in accordance with the calibration method indicated below. Newly acquired equipment without manufacturers certification and equipment that has not been calibrated or verified because it has been removed from service shall be calibrated or verified before being placed in service.

<b>Equipment</b>	<b>Calibration Method</b>
Bench Oven	NHDOT Procedure SC-2
Centrifuge Extractor	AASHTO T 164
Marshall Hammer	AASHTO T 245
Marshall Molds	AASHTO T 245
Mechanical shaker	AASHTO T 27, 7.4
Pressure Air Meter	AASHTO T 152
Proctor Molds	NHDOT Procedure SC-3
Proctor Manual Hammers	NHDOT Procedure SC-4
Scales and Balances	AASHTO M 231
Sieves	ASTM E-11 Methods 1&2
Slump Cone	NHDOT Procedure PC-5
Straight edge	NHDOT Procedure SC-6
Standard 1/10 ft <sup>3</sup> Container (Unit Weight Buckets)	NHDOT Procedure PC-2
Vacuum Pump	AASHTO T 209

Any equipment listed above required by Sections [401](#), [520](#), and [698](#) shall be calibrated by the Contractor in accordance with the calibration method specified.

The Contractor shall prepare and maintain record forms and a file for each piece of equipment in each laboratory requiring calibration or verification. The file and form for each piece of equipment shall contain detailed information identifying the equipment, records of calibration, or verification work performed in chronological order and the next date calibration or verification work is required (Month and Year) and shall be kept in the same laboratory as the equipment.

When any test equipment is overloaded, mishandled, giving results that are suspect, or is not meeting specification tolerances, the Engineer shall notify the Contractor and the equipment shall be taken out of service. The equipment shall be returned to service only after appropriate repairs are made and calibration and verification shows the equipment to function satisfactorily or to meet specification tolerances.

#### **106.03.1 Quality Control/ Quality Assurance (QC/QA).**

The Contractor may observe the Department's sampling and testing. If the Contractor believes that a sampling and/or test procedure deviates from the specified procedure, the Contractor shall describe the deviation to the Engineer's designated representative immediately and document the deviation in writing within twenty-four (24) hours. Immediately upon request and explanation of the deviation by the Contractor, the original sampling and/or testing will be completed and recorded, and then a second sample of the material will be taken and tested using what the Contractor believes to be the correct procedure. The specified sample and/or test method will be reviewed at a later time to determine which procedure is correct. The test result obtained using the procedure determined to be correct will be used for the subplot. The Contractor may dispute the results of acceptance tests performed in a laboratory. If the Contractor believes that a laboratory test result is in error, the Contractor shall substantiate the

## SECTION 106

reason for the belief that the test result is in error immediately and document the reasons in writing within 24 hours of this notification. If the Engineer agrees that there is sufficient reason to question the test result, the Engineer shall arrange to have the material tested by a different technician in a different Department laboratory or by an independent laboratory accredited by AASHTO in the test to be performed. If additional samples are necessary, the Contractor shall assist in obtaining the samples at no cost to the Department. If samples are to be taken from the finished work, the Contractor shall replace the removed material to the satisfaction of the Engineer, also at no cost to the Department.

If the original sampling and/or testing procedure or laboratory test result is found to have been done correctly, the Contractor shall bear the cost of the second sampling, testing, and evaluation, as shown in the table below. Such costs shall be deducted from any monies owed the Contractor.

TEST	COST
Concrete Air Test	\$200/test
Concrete Strength Test	\$200/test
Concrete W/C Ratio Test	\$200/test
Concrete Permeability Test	\$500/test
Concrete Cover Test	\$500/test
Asphalt Gradation and/or Voids Tests	\$200/test
Asphalt Voids and/or Thickness Tests	\$300/test
Asphalt Cross-Slope Measurement	\$200/test
Asphalt Ride Quality Test	\$1100/test

Items designated for acceptance under Quality Assurance (QA) provisions will be randomly sampled and tested in accordance with the recommended acceptance guidelines specified for that item. Acceptance tests will govern in all cases for determination of pay factors without regard to quality control tests.

**106.03.1.1** The Contractor shall provide Process Quality Control adequate to produce work of acceptable quality. The Contractor shall perform process quality control sampling, testing, and inspection during all phases of the work at a rate sufficient to assure that the work conforms to the Contract requirements and the minimum guidelines specified for that item.

The Engineer will not sample or test for Process Control or assist in controlling the Contractor's production operations. The Contractor shall provide personnel and testing equipment capable of providing a product that conforms to specified requirements. Continued production of non-conforming work at a reduced price, in lieu of adjustments to bring work into conformance, will not be allowed.

**106.03.1.2** The Contractor shall provide and maintain a Process Quality Control Plan, hereinafter referred to as the "Plan," including all the personnel, equipment, supplies, and facilities necessary to obtain samples, perform tests, and otherwise control the quality of the product to meet specified requirements.

The Contractor shall be prepared to present and discuss, at the pre-construction conference, quality control responsibilities for the specific items indicated in the Contract. The Contractor shall submit five copies of the Quality Control Plan to the Construction Bureau office in Concord directed to the appropriate District Construction Engineer a minimum of 20 working days prior to the pre-placement meeting. A copy of the cover letter or transmittal letter shall be forwarded to the Contract Administrator to notify project personnel of the plan submittal.

The Contractor shall not start work on the subject items without an approved Plan. Partial payment will not be made for materials subject to specific quality control requirements without an approved Plan. The approval process for the Contractor's Plan may include inspection of testing equipment and a sampling and testing demonstration by the Contractor's technician(s) to assure an acceptable level of performance.

**106.03.1.3** The Contractor shall schedule a pre-placement meeting a minimum of five working days prior to the start of related work. The meeting shall include the Plan Administrator, Contract Administrator, District Construction Engineer, Contractor, Supplier, and QC/QA Coordinator. Additional meetings may be required if changes to the plan or procedures are made, or when required to solve problems that arise.

**106.03.1.4** All Contractor process quality control testing under the Plan shall be performed by qualified technicians in laboratories approved by the Bureau of Materials and Research. Technician qualifications shall be as described in the specifications for the item being accepted under Quality Assurance provisions.

Laboratory facilities shall be kept clean and all equipment shall be maintained in proper working condition. The Engineer shall be permitted unrestricted access to inspect and review the Contractor's laboratory facility. The Engineer will advise the Contractor in writing of any noted deficiencies concerning the laboratory facility, equipment, supplies, or testing personnel and



procedures. Deficiencies shall be grounds for the Engineer to order an immediate stop to incorporating materials into the work until deficiencies are corrected.

**106.03.1.5** The Plan shall be administered by a qualified individual. Administrator qualifications shall be described in the specifications for the item being accepted under Quality Assurance provisions. The Plan Administrator or his/her approved designee shall be available whenever work under QC/QA specification is being performed.

The individual administering the Plan must be a full-time employee of or a consultant engaged by the Contractor. The individual shall have full authority to institute any and all actions necessary for the successful operation of the Plan.

**106.03.1.6** The Plan shall contain a system for sampling that assures all material being produced has an equal chance of being selected for testing. The Engineer shall be provided the opportunity to witness all sampling.

When directed by the Engineer, the Contractor shall sample and test any material that appears inconsistent with similar material being sampled, unless such material is voluntarily removed and replaced or corrected by the Contractor. All sampling shall be in accordance with Department, AASHTO, or ASTM procedures.

**106.03.1.7** All testing shall be performed in accordance with the acceptance test procedures applicable to the specified Contract items or other methods set forth in the approved Plan. Should acceptance test procedures not be applicable to quality control tests, the Plan shall stipulate the test procedures to be utilized. Upon request, the Contractor shall provide copies of all test results on forms meeting the approval of the Engineer.

**106.03.1.8** The Contractor shall maintain complete records of all process quality control tests and inspections. The records shall be available to the Engineer for review and copies furnished upon request.

Control Charts acceptable to the Engineer shall be maintained and kept current at a location satisfactory to the Engineer. As a minimum, the Control Charts shall identify the project number, the Contract item number, the test number, each test parameter, the upper and lower specification limit applicable to each test parameter, and the Contractor's test results. The Contractor shall use the Control Charts as part of a process control system for identifying production and equipment problems and for identifying pay factor reductions before they occur.

**106.03.2** Items specified to be sampled and tested on a Quality Assurance (QA) basis will be evaluated for acceptance in accordance with the guidelines specified for that item. All acceptance test results for a lot as defined in the specification will be analyzed collectively and statistically by the Quality Level Analysis-Standard Deviation Method using the procedures listed to determine the total estimated percent of the lot that is within specification limits. Test results on material not incorporated in the work will not be included in the quality level analysis.

**106.03.2.1** A lot containing non-specification material (less than 1.00 pay factor) will be accepted provided the pay factor is at least 0.75 and there are no isolated defects identified by the Engineer.

**106.03.2.2** A lot containing non-specification material that fails to obtain at least a 0.75 pay factor will be subject to the following:

The Contractor shall submit a procedure for correction of the non-specification material for approval by the Engineer. After any approved correction of any sublots, new samples from these sublots will be taken to be used in calculating pay factors for the lot and the old test results will be discarded. Alternatively, the Contractor may submit a written request for acceptance of the material at a negotiated price. Such request for acceptance shall include an Engineering analysis showing expected effects on performance and service life. The Engineer will determine whether the material may remain in place at the negotiated price.

**106.03.2.3** The Engineer may reject material that appears to be defective based on visual inspection. Such rejected material shall not be used in the work.

No payment will be made for the materials rejected by the Engineer unless the Contractor requests the rejected material be tested prior to disposal, and it is found to be acceptable. Three representative samples will be obtained and tested; and the results will be statistically evaluated. If found to have a pay factor of less than 0.75 or as otherwise specified, no payment will be made and the Contractor will bear the cost of the sampling, testing, and evaluation. If the pay factor is 0.75 or greater, or as otherwise specified, payment will be made for the materials at the invoice cost plus 10%.

## SECTION 106

**106.03.2.4** Quality Level Analysis - Standard Deviation Method procedures are as follows:

1. Determine the arithmetic mean ( $\bar{X}$ ) of the test results:

$$\bar{X} = \frac{\sum x}{n}$$

Where:  $\Sigma$  = summation of  
 $x$  = individual test value of  $x$   
 $n$  = total number of test values

2. Compute the sample standard deviation( $s$ ):

$$s = \sqrt{\frac{n\Sigma(x^2) - (\Sigma x)^2}{n(n-1)}}$$

Where:  $\Sigma(x^2)$  = summation of the square of individual test values.  
 $(\Sigma x)^2$  = summation of the individual test values squared.

3. Compute the upper quality index ( $Q_U$ ):

$$Q_U = \frac{USL - \bar{X}}{s}$$

Where: USL = upper specification limit.

4. Compute the lower quality index ( $Q_L$ ):

$$Q_L = \frac{\bar{X} - LSL}{s}$$

Where: LSL = lower specification limit.

5. Determine  $P_U$  (percent within the upper specification limit which corresponds to a given  $Q_U$ ) from Table 106-1.  
Note: If a USL is not specified,  $P_U$  will be 100.
6. Determine  $P_L$  (percent within the lower specification limit which corresponds to a given  $Q_L$ ) from Table 106-1.  
Note: If a LSL is not specified,  $P_L$  will be 100.
7. Determine the Quality Level (total percent within specification limits).  
Quality Level =  $(P_U + P_L) - 100$
8. Determine the Pay Factor (PF) for the lot from Table 106-2 using the Quality Level from step 7.
9. Determine the Composite Pay Factor (CPF) for each lot.

$$CPF = \frac{[f_1(PF_1) + f_2(PF_2) + \dots + f_j(PF_j)]}{\Sigma f}$$

Where:  $f_j$  = price adjustment factor listed in the specifications for the applicable property.

$PF_j$  = Pay Factor for the applicable property.

$\Sigma f$  = Sum of the "f" (price adjustment) factors.

Note: Numbers used in the above calculations will be rounded to 3 places after the decimal point. Pay factors and Composite Pay Factors will be computed to 2 places after the decimal point.

**106.03.2.5** If a measured characteristic is not included in the Contract or is not evaluated due to Department-owned test equipment being inoperable, its pay factor shall be 1.00 when calculating the CPF.

### **106.03.3 Random Sampling Locations.**

The selection of the sampling locations for quality assurance tests must be entirely random. This procedure shall be used for determining the location for taking a sample in order to eliminate any intentional or minimize any unintentional bias on the part of the person taking the sample.

Sampling locations shall be determined on the basis of time, tonnage, volume, distance, area, and the size of the subplot to be sampled. Random numbers shall be selected using the procedures outlined below. Once the random numbers have been selected, they shall be applied to the subplot sizes to determine sampling location.

**106.03.3.1 Sampling In-Place Roadway Material:** Determine tonnage of the subplot. Following method #1 or method #2, pick two random numbers for each subplot. Multiply the random numbers by the width and tonnage to arrive at the sampling location.

Example: A subplot is 750 tons. The lane being paved is 12 ft. wide. Using a random number, which is then multiplied by 750. In this instance, the number chosen was 0.376. Thus, the sample will be taken at 282 tons from the beginning of the subplot. Determine the location from the edge of the pavement by using the second random number, which is then multiplied by 12 ft. In this instance, the number chosen was 0.512. Therefore, the sample should be taken at 282 tons from the beginning of the subplot and 6 ft. from the designated (right or left) edge of the pavement.

**106.03.3.2 Sampling Concrete Truck Loads:** Determine the quantity that represents a subplot of material. To determine which trucks to sample, choose a random number and multiply this number by the total quantity in the subplot. This will give an indication on when to take the sample.

Example: A subplot of concrete is 50 cy. Using a random number, which is then multiplied by 50 cy. In this instance, the number chosen is 0.763. The result comes out at 38 cy, which falls in the 5<sup>th</sup> load (assuming 8 cy. per load). Sample the concrete within the middle third of the 5<sup>th</sup> load.

**106.03.3.3 Random Numbers.** Random numbers may be obtained by using the random number generator function found on hand-held calculators or computer spreadsheet programs.



**Table 106-2 PAY FACTORS**

Pay Factor	Required Quality Level for a Given Sample Size(n) and Given Pay Factor																																																														
	<table style="width:100%; border:none;"> <tr> <td style="width:12.5%;"></td><td style="width:12.5%; text-align:center;">n=</td><td style="width:12.5%; text-align:center;">n=</td><td style="width:12.5%; text-align:center;">n=</td><td style="width:12.5%; text-align:center;">n=</td><td style="width:12.5%; text-align:center;">n=</td><td style="width:12.5%; text-align:center;">n=</td><td style="width:12.5%; text-align:center;">n=</td><td style="width:12.5%; text-align:center;">n=</td><td style="width:12.5%; text-align:center;">n=</td><td style="width:12.5%; text-align:center;">n=</td><td style="width:12.5%; text-align:center;">n=</td><td style="width:12.5%; text-align:center;">n=</td><td style="width:12.5%; text-align:center;">n=</td><td style="width:12.5%; text-align:center;">n=</td><td style="width:12.5%; text-align:center;">n=</td> </tr> <tr> <td></td><td style="text-align:center;">10</td><td style="text-align:center;">12</td><td style="text-align:center;">15</td><td style="text-align:center;">19</td><td style="text-align:center;">26</td><td style="text-align:center;">38</td><td style="text-align:center;">70</td><td style="text-align:center;">201</td><td></td><td></td><td></td><td></td><td></td><td></td><td></td> </tr> <tr> <td></td><td style="text-align:center;">to</td><td style="text-align:center;">to</td><td style="text-align:center;">to</td><td style="text-align:center;">to</td><td style="text-align:center;">to</td><td style="text-align:center;">to</td><td style="text-align:center;">to</td><td style="text-align:center;">To</td><td></td><td></td><td></td><td></td><td></td><td></td><td></td> </tr> </table>																n=	n=	n=	n=	n=	n=	n=	n=	n=	n=	n=	n=	n=	n=	n=		10	12	15	19	26	38	70	201									to	to	to	to	to	to	to	To							
		n=	n=	n=	n=	n=	n=	n=	n=	n=	n=	n=	n=	n=	n=	n=																																															
	10	12	15	19	26	38	70	201																																																							
	to	to	to	to	to	to	to	To																																																							
	n=	n=	n=	n=	n=	n=	n=	n=	n=	n=	n=	n=	n=	n=	n=																																																
1.05	100	100	100	100	100	100	100	100	100	100	100	100	100	100	100																																																
1.04	90	91	92	93	93	93	94	94	95	95	96	96	96	97	99																																																
1.03	80	85	87	88	89	90	91	91	92	93	93	94	95	96	97																																																
1.02	75	80	83	85	86	87	88	88	89	90	91	92	93	94	95																																																
1.01	71	77	80	82	84	85	85	86	87	88	89	90	91	93	94																																																
1.00	68	74	78	80	81	82	83	84	85	86	87	89	90	91	93																																																
0.99	66	72	75	77	79	80	81	82	83	85	86	87	88	90	92																																																
0.98	64	70	73	75	77	78	79	80	81	83	84	85	87	88	90																																																
0.97	62	68	71	74	75	77	78	78	80	81	83	84	85	87	89																																																
0.96	60	66	69	72	73	75	76	77	78	80	81	83	84	86	88																																																
0.95	59	64	68	70	72	73	74	75	77	78	80	81	83	85	87																																																
0.94	57	63	66	68	70	72	73	74	75	77	78	80	81	83	86																																																
0.93	56	61	65	67	69	70	71	72	74	75	77	78	80	82	84																																																
0.92	55	60	63	65	67	69	70	71	72	74	75	77	79	81	83																																																
0.91	53	58	62	64	66	67	68	69	71	73	74	76	78	80	82																																																
0.90	52	57	60	63	64	66	67	68	70	71	73	75	76	79	81																																																
0.89	51	55	59	61	63	64	66	67	68	70	72	73	75	77	80																																																
0.88	50	54	57	60	62	63	64	65	67	69	70	72	74	76	79																																																
0.87	48	53	56	58	60	62	63	64	66	67	69	71	73	75	78																																																
0.86	47	51	55	57	59	60	62	63	64	66	68	70	72	74	77																																																
0.85	46	50	53	56	58	59	60	61	63	65	67	69	71	73	76																																																
0.84	45	49	52	55	56	58	59	60	62	64	65	67	69	72	75																																																
0.83	44	48	51	53	55	57	58	59	61	63	64	66	68	71	74																																																
0.82	42	46	50	52	54	55	57	58	60	61	63	65	67	70	72																																																
0.81	41	45	48	51	53	54	56	57	58	60	62	64	66	69	71																																																
0.80	40	44	47	50	52	53	54	55	57	59	61	63	65	67	70																																																
0.79	38	43	46	48	50	52	53	54	56	58	60	62	64	66	69																																																
0.78	37	41	45	47	49	51	52	53	55	57	59	61	63	65	68																																																
0.77	36	40	43	46	48	50	51	52	54	56	57	60	62	64	67																																																
0.76	34	39	42	45	47	48	50	51	53	55	56	58	61	63	66																																																
0.75	33	38	41	44	46	47	49	50	51	53	55	57	59	62	65																																																

**NOTE:** To obtain a given pay factor, the computed Quality Level shall equal or exceed the value in the table.  
Delete Pay Factor rows more than 1.0 where quality incentives are not allowed.

**106.04 Certification of Compliance.**

The Contractor shall provide a Certificate of Compliance for all materials that are to be permanently incorporated into the Work for which there is no prescribed schedule of acceptance testing by the Engineer. If more than one product is used for the same purpose, a Certificate of Compliance shall be submitted for each product. [Certificates of Compliance](#) shall be submitted on the form shown below. Certificates will also be required for temporary, safety-related items, such as guardrail, impact attenuators, traffic control devices, and pavement markings. No payment will be made for any item until the required certificates have been received. The certificate shall show the following:

- (a) Date of certification.
- (b) Description of material supplied.
- (c) Product Trade Name (as listed on the [Qualified Products List](#) if applicable).
- (d) Name of manufacturer and/or supplier.
- (e) Name of the Contractor to whom the material is supplied.
- (f) Project name and number to which the material is consigned.
- (g) Contract item number and Contract item name.

## SECTION 106

- (h) A statement that the material or assemblies provided fully meets the requirements of the pertinent Contract Specification.
- (i) That records will be maintained for a three-year period as defined below.
- (j) Signature of a person having legal authority to bind the originator of the certificate.
- (k) If the product category is listed on the [Qualified Products List](#), the location where the product was used shall be provided.

Certificates of Compliance may be submitted, by the manufacturer, the supplier, or the Contractor. The required Certificate of Compliance form may be obtained online at the [Department's Website](#) or from the Engineer. In all cases, the Contractor shall fill out the project-related location information at the bottom of the form for products listed on the [Qualified Products List](#). The originator of the certificate must maintain all documentation for said certificates for a period of not less than three years from the date the project has been completed and accepted.

Certificates of Compliance covering more than one type of material or item will be acceptable if a listing is made of the item number, name of item, manufacturer, or supplier or both for each material covered.

Materials or assemblies used on the basis of Certificates of Compliance may be sampled and tested by the Department and if determined not to meet Contract requirements will be rejected or accepted under 105.03. All work done to replace or repair defective material shall be at the Contractor's expense. This provision shall remain in force for a period of three years from the date of Acceptance.

The following is a list of materials that require Certificates of Compliance. This list is not all-inclusive, as certain special materials not commonly used on all projects will also require certificates.

Bearing Assemblies	Light Pole Bases
Bearing Pads	Liquid Asphalt Materials
Bearing Piles and Permanent Sheeting	Luminaries and Supports
Bounds (Concrete and Granite)	Matting for Erosion Control
Bridge Elastomeric Expansion Devices	Membrane Waterproofing
Bridge Railing and Hardware	Paint for Structural Steel
Castings of Grates, Frames and Covers	Pavement Fabrics
Concrete Curing, Waterproofing, Sealing Agents and Admixtures	Pavement Markings consisting of Tapes, Thermoplastics, Markers and Paints
Conduits and Pull Boxes	Permanent/Temporary Lighting Systems
Culverts, Underdrains, Structural Plate Pipe and Structural Plate Arches	Pipe and Accessories for Water, Sewer and Drainage
Delineators	Reinforcing Steel
Drainage/Sewer Structures	Shear Connectors
Fence Materials consisting of Posts, Fabric and Hardware	Sign Materials consisting of Posts, Trusses, Fasteners, Sheeting and Panels
Geotextiles	Structural Steel
Guardrail consisting of Beam Rail, Posts and Fittings	Traffic Control Devices
Impact Attenuators	Traffic Signals and Equipment
Joint Sealants	Waterstops
	Witness Markers

Supplementing the above certificates, when specified or upon request, the Engineer shall be furnished with a copy of the manufacturer's certificate of materials showing the physical properties, chemical composition, methods of testing, and other relevant data.

Products that have been prequalified by Materials and Research and are included on the [Qualified Products List \(QPL\)](#) may be used on projects without further testing, unless otherwise noted on the QPL, but a Certificate of Compliance for the qualified products will be required. The QPL is updated annually, or more frequently if warranted, and is available online at the [Department's Website](#). A product that is not listed will not be used until qualified through a written request to Materials and Research. Such request should be made with sufficient lead-time to allow necessary testing or research.

### 106.05 Plant Inspection.

The Engineer may inspect materials at the acquisition or manufacturing source. Manufacturing plants may be inspected for compliance with specified manufacturing methods. Material samples will be obtained for testing for compliance with materials quality requirements. This may be the basis for acceptance of manufactured lots as to quality.

In the event plant inspection is undertaken, the following conditions shall be met:

1. The Engineer shall have the cooperation and assistance of the Contractor and the producer of the materials.

2. The Engineer shall have full access at any time to all parts of the plant concerning the manufacture or production of the materials being furnished.

3. If required by the Contract, a building shall be provided for the use of the Inspector in which to house the test equipment and perform the required tests. The building shall be located conveniently near the plant, and independent of any use by the material producer.

4. Adequate safety measures shall be provided and maintained.

#### **106.06 Storage and Handling of Materials.**

Materials shall be stored, handled, and transported to preserve their quality and fitness for the Work.

Materials shall be stored to facilitate prompt inspection and will be subject to inspection and retesting before incorporation in the Work in accordance with 106.03.

Approved portions of the right-of-way may be used for storage of materials and the Contractor's plant and equipment, provided that the clear zone restrictions specified in Section 619 are met. Clearing, grubbing, topsoil removal, and other preparation work or restoration for storage areas, if approved, shall be at the Contractor's expense.

Additional space required shall be provided at the Contractor's expense and option. Private property shall not be used for storage purposes without written permission of the owner, or lessee and owner. Copies of such written permission shall be furnished to the Engineer and shall include proposed erosion control and site restoration measures.

Storage and plant sites shall be restored to their original condition, or as directed, by and at the Contractor's expense.

Erosion control measures, including dust control required for stockpiles of materials subject to wind or water erosion, shall be by and at the Contractor's expense.

#### **106.07 Unacceptable Materials.**

Materials not meeting the requirements of the Contract will be considered unacceptable and will be rejected and shall be removed immediately from the project unless the defects are corrected and approved by the Engineer. Should the Contractor fail to remove defective materials within the time indicated by the Engineer in writing, the Engineer will have the materials removed at the Contractor's expense.

#### **106.08 Department-Furnished Material.**

Material furnished by the Department will be delivered or made available to the Contractor at the locations specified in the Contract.

The cost of handling and placing Department-furnished materials after delivery to the Contractor shall be included in the Item Bid Price for the item in which they are used. The Contractor is responsible for materials delivered. Deductions will be made from any money due the Contractor for any shortages, deficiencies, and damage that may occur to the material after delivery. Demurrage charges, resulting from the Contractor's failure to accept the material at the designated time and location of delivery, will also be deducted from money due the Contractor.

#### **106.09 Conservation of Gravel Deposits.**

The Contractor shall make all reasonable efforts to conserve gravel deposits. Unless specifically authorized, gravel shall not be utilized in making deep fills, backfilling swamps, or dressing slopes. Gravel deposits encountered in the excavation shall be used in the several gravel items in the Contract when directed. Disposal of strippings, overburden, and unsuitable material shall be made in such a manner that usable gravel deposits will not be covered.

#### **106.10 Disposal of Surplus and Waste Materials.**

When practicable and whenever directed, surplus and waste material shall be disposed of by flattening slopes or for other grading within the project. When specified as embankment-in-place surplus or stockpile surplus, the material shall be placed as shown on the Plans or as directed in the Proposal in accordance with the appropriate specification. In case it is impossible to dispose of all the surplus and waste material in the manner described above, it shall be the Contractor's responsibility to secure disposal areas for surplus and waste materials. Disposal Agreements, as provided by the Department, for such areas must be submitted to the Engineer for approval. The [Disposal Agreement](#) form may be obtained on line at the [Department's Website](#) or from the Engineer.

**SECTION 107 -- LEGAL RELATIONS AND RESPONSIBILITY TO PUBLIC****107.01 Laws to be Observed.**

The Contractor shall keep fully informed with, and observe and comply with all Federal and State laws, all local laws and ordinances, and regulations, orders, and decrees of bodies or tribunals having any jurisdiction or authority, that affect individuals engaged or employed on the Project, or that affects the conduct of the Work on the Project. The Contractor shall protect, defend, and indemnify the Department and its representatives against any claim or liability arising from or based on the violation of any such law, ordinance, regulation, order, or decree, whether by the Contractor, Subcontractor(s) at any tier, suppliers of materials or services, or others engaged by the Contractor, or their employees.

The Engineer is to be notified immediately in writing if any discrepancy or inconsistency is discovered between the Contract and any law, ordinance, regulation, order, or decree except as noted in 107.04.

The Contractor's attention is called to RSA 275:43, which provides for weekly payment to employees, and to RSA 235:37, which provides requirements relative to worker's compensation. The latter statute provides that the Commissioner of Transportation shall require every private Contractor engaged in construction or maintenance work by Contract with the State, a county, a city or town, on any State, State-aid, or town-aid highway or bridge project to file with the Commissioner of Labor and the Commissioner of Transportation of the State a declaration of acceptance of the provisions of RSA Chapter 281-A, Worker's Compensation, as amended, before any Work is begun on such project.

**Bulletin Board Requirements:** The Contractor shall erect and maintain a bulletin board on which to post the notices, rates, and related items that are required to be posted. The board shall be a minimum of 4 foot by 8 foot in order to allow sufficient space, without overlapping, for both State and Federal poster/information, as required. Additional work classifications and their rates, requested by the Contractor and subsequently approved by the USDOL, shall also be posted. Bulletin boards shall be an enclosure and the posted documents shall be protected from the elements by glass or Plexiglas. Boards shall be erected on the site of work, be placed in a conspicuous and accessible location where it can be easily seen by all workers. If placing the bulletin board on the site of work is not feasible, either for safety reasons or due to the work taking place, the Contractor may recommend placing it in an adjacent location subject to NHDOT approval. If the NHDOT deems the alternate location as unsuitable (the location is too distant or will not be utilized by all Subcontractors, etc.), the NHDOT may instead require the use of employee bulletin board handouts in accordance with FHWA policy. Contractors have two options for posters: Option 1 - Using "all-in-one" Federal and State posters; or Option 2 - Arranging posters in a predetermined manner as shown in the Proposal. The bulletin board shall remain the property of the Contractor and shall be removed upon completion of the Work.

Except for Work done under items in the Contract, work prescribed in this section will not be paid for separately but will be considered as subsidiary.

The Contractor's attention is further called to RSA 281-A:18, which reads in part:

**" 281-A:18 Contractor's Liability for Subcontractors.** A Contractor who subcontracts all or any part of a Contract shall bear the liability of the Subcontractor of that contract for the payment of compensation under this chapter to the employees of the Subcontractor, unless the Subcontractor has secured the payment of compensation as provided for in this chapter. Any Contractor who shall become liable for compensation under this section may recover the amount of the compensation paid and necessary expenses from the Subcontractor. ..."

The Contractor's attention is further called to RSA 266:72, which reads in part:

**" 266:72 Spillage of Material.**

- I. No vehicle shall be driven or moved on any way unless such vehicle is so constructed or loaded as to prevent any of its load from dropping, sifting, leaking or otherwise escaping therefrom, except that sand may be dropped for the purpose of securing traction, or water or other substance may be sprinkled on a way in cleaning or maintaining such way.
- II. No person shall operate on any way any vehicle with any load unless said load and any covering thereon is securely fastened so as to prevent said covering or load from becoming loose, detached, or in any manner a hazard to other users of the way. Without limiting the foregoing provision, no person shall drive on any way any open vehicle loaded with earth, sand, asphalt, stone, gravel, or other particulate substance unless said vehicle is equipped with and said load is entirely covered and secured by a tarpaulin or similar covering which prevents the escape of any substance from said load onto the way.
  - II-a. No person shall operate on any way any open vehicle loaded with light scrap metal, unless the load is covered with and secured by a close-fitting tarpaulin which prevents the escape of any light scrap metal from the load onto the way. For the purposes of this paragraph "light scrap metal" means any fragments less than 8" wide and no more than 1/8" thick of manufactured metal articles or shredded metal parts rejected or discarded and useful only as material for reprocessing. The provisions of this paragraph shall not apply to truck operators transporting crushed vehicles to shredding facilities or to transporters of heavy scrap metals to or from metal scrap dealers or remelting facilities.



- III. Any person who violates the provisions of this section shall be guilty of a violation if a natural person, or guilty of a misdemeanor if any other person. Any person shall be liable to the state or town for any damage done to the way by spillage.
- IV. The provisions of paragraphs I, II, II-a, and III of this section shall not apply to a local farmer transporting his or her own farm products or materials incidental to a local farming operation where such transporting requires incidental use of a way, provided that such farmer shall not thereby be relieved of his or her duty to exercise reasonable care to prevent hazardous spillage.
- V. The provisions of paragraphs II and II-a shall not apply to:
  - (a) The operation of construction equipment as defined in RSA 259:42 and motor vehicles used in the construction of highways provided that such equipment or motor vehicle is used within a highway construction zone as prescribed by the commissioner of transportation, provided that the driver of any such vehicle shall not thereby be relieved of the duty to exercise reasonable care;
  - (b) The operation of municipal and state highway maintenance equipment;
  - (c) The driving of any vehicle on a way at speeds of less than 30 miles per hour. Extensions to a Construction Zone allowed by the Commissioner will not waive the requirement for covered loads beyond such limits.

Projects in this State occur within watersheds under the management of the New Hampshire Department of Environmental Services, Water Division (WD). The purpose of part Env-Ws 1700 of the NH Code of Administrative Rules is to “establish water quality standards for the State’s surface water uses as set forth in RSA 485-A.” The Contractor’s attention is further called to RSA 146-A Oil Discharge or Spillage in Surface Water or Groundwater. The Contractor must take sufficient precautions to prevent the runoff of fuels, oils, bitumens, calcium chloride, or other polluting materials, harmful to humans, fish, or other life, into the water supplies and surface waters of the State. The Contractor shall have oil spill kits on site and readily available during construction.

Unless otherwise permitted by the WD, control measures must be adequate to assure that turbidity in the receiving water due to the runoff of silt and clay will not be increased to more than ten (10) nephelometric turbidity units (NTU) above naturally occurring conditions in Class B waters. Class A waters shall contain no turbidity, unless naturally occurring. Proper planning and scheduling of construction operations are major factors in controlling erosion. Construction of drainage facilities and performance of other Work that will contribute to the control of erosion and sedimentation shall be carried out concurrently with earthwork operations or as soon thereafter as practicable. Where there is a high potential for erosion and subsequent water pollution, the duration of the exposure of the uncompleted construction to the elements shall be kept to a minimum. Fine material placed or exposed during the Work shall be so handled and treated as to minimize the possibility of its reaching any stream or water supply. Diversion channels, dikes, sediment traps, and any other effective measures may be used. Where applicable and unless otherwise permitted where an alternate procedure would be acceptable to the State and the Contractor, before water shall be allowed to run into any ditch or channel, the waterway shall be prepared with permanent erosion control measures so that the waterway will be safe against erosion. Prior to beginning the work, the Contractor shall submit a schedule of operations indicating the special precautions proposed to control erosion.

Special precautions shall be taken in the use of construction equipment to minimize erosion. Wheel tracks shall not be left where erosion might begin. Wherever crossing of live streams is necessary, temporary culverts or bridges shall be constructed to allow equipment to cross. Fording of streams shall not be permitted unless approved by the Engineer and appropriate permits have been obtained. Disturbance of lands and waters that are outside the limits of the construction as staked will be prohibited except as may be found necessary and ordered.

All waterways shall be cleared as soon as practicable of falsework, piling, debris, or other obstructions placed during construction operations and not a part of the finished Project.

Prior to suspension of construction operations for appreciable lengths of time, the Contractor shall shape the earthwork in a manner that will permit storm runoff with a minimum of erosion. Temporary erosion and sediment control measures such as berms, dikes, slope drains, or sedimentation basins shall be provided and maintained until permanent drainage facilities and erosion control features have been completed and are operative.

The Contractor’s attention is called to RSA 482-A:3 **Excavating and Dredging Permit; Certain Exemptions** which reads in part:

**“ 482-A:3 Excavating and Dredging Permit; Certain Exemptions.**

- I. (a) No person shall excavate, remove, fill, dredge, or construct any structures in or on any bank, flat, marsh, or swamp in and adjacent to any waters of the state without a permit from the department. Unless otherwise specified in rules adopted by the commissioner pursuant to RSA 482-A:11, any person seeking to obtain a permit shall submit to the department:

- (1) A complete application form that has been signed by the town or city clerk of the municipality in which the property is located or, if the property is located in more than one municipality, by the city or town clerk of each such municipality, certifying that the municipality has received 4 copies of the form and attachments as provided in subparagraph (a)(2). The town or city clerk shall send a copy of the form and attachments to the local governing

## SECTION 107

body, the municipal planning board, if any, and the municipal conservation commission, if any, and shall retain one copy to be made reasonably accessible to the public. Applications and fees for projects by agencies of the state may be filed directly with the department, with 4 copies of the application, plan, and map filed at the same time with the town or city clerk.

(2) Such other information as required by rules adopted by the commissioner pursuant to RSA 482-A:11, which may include maps and plans.

(3) A nonrefundable application fee as specified in subparagraphs (b) or (c), as applicable.

(b) The application fee for shoreline structure projects shall be \$200 plus an amount based on the area of dredge, fill, or dock surface area proposed, or a combination thereof, which shall be \$2 per square foot for permanent dock surface area; \$1 per square foot for seasonal dock surface area; and \$.20 per square foot for dredge or fill surface area or both. For projects involving only the repair, reconstruction, or reconfiguration of an existing docking structure, the application fee shall be \$200.

(c) The application fee shall be \$200 for minimum impact dredge and fill projects under this chapter. The application fee for all projects under this chapter which are not covered by subparagraph (b) or (c) or paragraphs IV-a, V, X through XII, XV, XVI, or XVII through XIX shall be \$.20 per square foot of proposed impact, with a minimum fee of \$200 for all such projects that impact fewer than 1,000 square feet.... “

and RSA 485-A:17 **Terrain Alteration** which reads in part:

“ **485-A:17 Terrain Alteration.** I. Any person proposing to dredge, excavate, place fill, mine, transport forest products or undertake construction in or on the border of the surface waters of the state, and any person proposing to significantly alter the characteristics of the terrain, in such a manner as to impede the natural runoff or create an unnatural runoff, shall be directly responsible to submit to the department detailed plans concerning such proposal and any additional relevant information requested by the department, at least 30 days prior to undertaking any such activity. The operations shall not be undertaken unless and until the applicant receives a permit from the department. The department shall have full authority...”

In order to prevent the dissemination of harmful or destructive plants or insects, no person shall collect, transport, sell, distribute, propagate, transplant or release any living and viable portion of any plant or any insect species listed in Table 3800.1 of Part AGR 3802 of the New Hampshire Code of Administrative Rules (Statutory Authority RSA 430:55).

Complete information may be secured from the NH Department of Agriculture, Markets & Food Division of Plant Industry.

The Contractor shall also protect the atmosphere from particulate and gaseous pollutants in conformance with rules promulgated by the New Hampshire Department of Environmental Services, Air Resources Division.

The Contractor's attention is called to Part Env-A 1000 Prevention, Abatement and Control of Open Source Air Pollution; which reads in part:

Env-A 1001.04 General Open Burning Requirements. Open burning in any part of the state shall be permissible when the burning:

- (a) Is conducted in accordance with all local ordinances;
- (b) Is authorized by an official having jurisdiction over open burning, whenever authorization is required;
- (c) Does not create a nuisance; and
- (d) Includes only materials burned in conformance with this part.

The Air Resources Division may order unauthorized burning to cease and may order authorized burning creating a nuisance to cease. The order may be issued directly to the Contractor or to the Contractor through the Engineer.

### 107.02 Permits, Licenses, and Taxes.

The Contractor shall procure all permits and licenses, pay all charges, fees, and taxes, and give all notices necessary and incidental to the due and lawful prosecution of the Work. The costs for all charges, fees, and taxes shall be included in the unit prices bid for the various items of the Contract. Necessary permits from the proper authorities for the Work as shown on the Plans or indicated in the Proposal in coastal and inland waters and wetlands within the State have been or will be obtained by the Department as described in the Prosecution of Work. It will be the Contractor's responsibility to secure permits, variances, or modifications to the permits secured by the Department for additional work not shown on the Plans or work necessary for the Contractor's method of construction. Additional work shall not begin until permits, variances, or modifications have been obtained.

Permit applications for Work within waters of the State are obtainable from the Wetlands Bureau, State of New Hampshire, Department of Environmental Services, 29 Hazen Drive, PO Box 95, Concord, NH 03302-0095, or from their website at [www.des.state.nh.us/wetlands](http://www.des.state.nh.us/wetlands). Applications may also be obtained from town and city clerk offices. This permit process may take

60 days or more to complete. Furthermore, if warranted, additional time should be allowed for a public hearing in accordance with RSA 482-A:8.

The Contractor is further notified that if the total project impact to wetlands under the jurisdiction of the United States Army Corps of Engineer (USACOE) (work shown on the Plans plus additional work proposed by the Contractor) is between 3000 ft<sup>2</sup> and 3 acres, the State permitting process is subject to Federal review. The USACOE will notify the applicant within 30 days after issuance of the State permit if a USACOE individual permit is required. If the total project impact to jurisdictional wetlands exceeds 3 acres, then an USACOE individual permit is required and the application is subject to a Federal public hearing, which may require submission of additional information to the USACOE.

The attention of the Contractor is called to RSA Chapter 293-A, Business Corporation Act, which, among other provisions, requires that out-of-state corporations obtain a certificate of authority to do business in the State from the Secretary of State; to RSA Chapter 305-A, Registration of Foreign Partnerships, which, among other provisions, requires that every foreign partnership desiring to do business in this State shall register with and obtain a certificate of authority to do business in the State from the Secretary of State; and to RSA Chapter 349, Trade Names, which, among other provisions requires that every sole proprietor doing business in this State under any other name than their own shall register the trade name of such business, and that every person, proprietorship, partnership, or association, engaged in the conduct of any business, enterprise, venture, or activity within the State under a trade name, firm, or style shall, subject to limitations, file in the office of the Secretary of State a certificate signed and sworn to by such person or proprietorship or by members of such partnership or association stating the name under which the business is to be conducted, the principal place of said business, and a brief description of the kind of business to be carried on, with the names and addresses of the principal parties engaged therein.

The Contractor's attention is further called to RSA 72-B, Excavation Tax and related administrative rules of the Department of Revenue Administration, which among other provisions, levies a tax on earth and excavations as defined in RSA 155-E. The Contractor is required, on a yearly basis, to file a Notice of Intent to Excavate in each municipality where excavation operations are anticipated. Additionally, the Contractor shall post the Excavation Tax Certificate, received from the Department of Revenue Administration, at the Contractor's project bulletin board.

Bidders with the word "Engineer" or any form of such word in the name of their business should review RSA 310-A:20, which prohibits the Secretary of State from issuing a certificate of incorporation to any business or registering a foreign business organization with any derivative of the word "Engineer" in its name or which practices Engineering until the business organization obtains a certificate of authorization from the State Board of Licensure for Engineers.

---

The Contractor's attention is further called to RSA 80:7, RSA 80:7a, RSA 80:7b, and RSA 80:7c, which read:

- “ 80:7 Contractors’ Taxes.** Whenever any person, firm or corporation enters into a Contract or agreement with the state or any political subdivision thereof it shall be a term or condition of such Contract that the state or such political subdivision shall withhold or retain from the Contract price provided for in such Contract such sum or sums as will secure the payment of the taxes levied and assessed against the property of such Contractor or against the property for which such Contractor may be liable for the payment of taxes thereon, until such taxes are paid by such Contractor, or are authorized paid by him from the sums so withheld, provided the collector of taxes or other person responsible for the collection of such taxes notifies the treasurer of the state or political subdivision that such taxes have been assessed but are unpaid. Such notice shall not be given to the treasurer as aforesaid until the expiration of a period of ten days after the collector or other person responsible for the collection of the taxes has presented or sent by first class mail, postage prepaid, addressed to the last known address of such Contractor a tax bill, or a duplicate or copy of the tax bill presented or sent to a Subcontractor or lessee for the payment of whose taxes said Contractor is liable together with a notation to said Contractor stating therein a date certain when said collector or other person responsible for the collection of such taxes will notify the treasurer as aforesaid. If the taxes so assessed are not paid by the person, firm or corporation liable therefore by December first of the year of assessment, the treasurer, upon notice from the collector of taxes that the taxes remain unpaid, shall pay over the amounts withheld to the collector and take his receipt therefore which shall be a full and complete discharge of the treasurer from any further liability for the sum so withheld. If on December first the person, firm or corporation is not entitled to sufficient sums under the Contract from which the treasurer can withhold the amount of taxes due, the treasurer as soon thereafter as sufficient sums are available for the purpose shall immediately pay over to the collector the sums so withheld. If the person, firm or corporation shall pay to the collector the taxes for which he or it is liable after notice to withhold by the collector to the treasurer, the collector shall immediately notify the treasurer so withholding, and the sum so withheld shall be paid to the person, firm or corporation, if otherwise due.
- 80:7-a Subcontractors’ Taxes.** Whenever a person, firm or corporation enters into a Contract or agreement with the state or any political subdivision thereof and such Contractor employs a Subcontractor to perform any of the work contemplated by such Contract or agreement, it shall be a stated term or condition of such Contract, that said Contractor will be liable for the payment of any taxes assessed in the name of and upon the property of the

## SECTION 107

Subcontractor, used by said Subcontractor in the performance of said subcontract if assessed while said Contract is being performed, to the extent of any sum or sums that may be due from the Contractor to the Subcontractor at the time of or after the Contractor has been notified by the collector of taxes in writing that payment of said taxes has been demanded of said Subcontractor but said Subcontractor has failed, neglected or refused to pay the same. Said Contractor may retain from the Contract price the amount for which he is liable hereunder. The amount of the taxes for which the said Contractor may be liable hereunder may be withheld or retained from the Contract price under the provisions of RSA 80:7.

**80:7-b User's Taxes.** Whenever a person, firm or corporation enters into a Contract or agreement with the state or any political subdivision thereof and such Contractor has in his possession and uses any taxable property owned by another upon the job to be performed under the Contract or agreement, it shall be a stated term or condition of such Contract that the Contractor having such property in his possession shall be liable for the amount of taxes assessed against such property in the name of the owner of such property while the same is in the possession of such Contractor to the extent of the amount of any sum or sums of money that may be due from said Contractor to the owner of such property for rental or hire thereof at the time of or after the collector of taxes has notified said Contractor in writing that he has made demand upon the owner of such property for payment of the taxes assessed upon said property but that the owner of such property has failed, neglected or refused to pay said taxes. Said Contractor may retain from the sums to be paid for the use of such property the amount for which he is liable hereunder. The amount of the taxes for which the said Contractor may be liable hereunder may be withheld or retained from the Contract price under the provisions of RSA 80:7.

**80:7-c Exemption from Attachment.** The sums so withheld by the treasurer of the state or any political subdivision thereof upon notice from a collector of taxes under the provisions of RSA 80:7 and the sums so withheld and to be withheld by any Contractor under the provisions of 80:7-a and 80:7-b shall be exempt from attachment, garnishment and trustee process by any person except in an action or suit brought by the collector of taxes to collect such taxes.”

### 107.03 Patented Devices, Materials, and Processes.

If the Contractor employs any design, device, material, or process covered by letters of patent or copyright, the Contractor shall provide for such use by suitable legal agreement with the patentee or owner. The Contractor and Contract Surety shall defend and indemnify the Department, any affected third party, or political subdivision from any and all claims for infringement by reason of the use of any such patented or copyrighted design, device, material, or process, or any trademark or copyright.

The Contractor shall indemnify the Department from costs, expenses, and damages that may be obligated for payment by reason of an infringement during the prosecution of the Work or after the completion of the Project.

### 107.04 Federal Aid Participation.

When any Federal laws, rules, or regulations are in conflict with any provisions of a federally assisted Contract, the Federal requirements shall prevail, take precedence, and be in force over and against any such conflicting provisions.

If there is Federal participation in the cost of the Contract, the Work shall be under the supervision of the Department but subject to the inspection and approval of the proper officials of the United States Government. Inspections made by authorized Federal representatives shall not make the United States Government a party to the Contract and will not interfere with the rights of the Contract parties.

### 107.05 Sanitary, Health, and Safety Provisions.

The rules and regulations of Federal, State, and local health officials shall be observed. No employees of the Contractor or Subcontractor(s) shall be required to work in surroundings, or under conditions that are unsanitary, hazardous, or dangerous to their health or safety. Any inspector of the OSHA or other legally responsible agency involved in safety and health administration shall be admitted without delay and without presentation of an inspection warrant to all areas of the Work and Project upon presentation of proper credentials.

The Contractor shall provide and maintain in a neat, sanitary condition such accommodations for the use of its employees and Department representatives as may be necessary to comply with the requirements of the State Board of Health, or of other bodies or tribunals having jurisdiction. Except as provided under Section 698, this work shall be subsidiary.

The Federal occupational safety and health standards comprise Part 1910 and Part 1926 respectively of Title 29 of the Code of Federal Regulations and are amended periodically in the Federal Register. In case any revisions in the Code of Federal Regulations are published, such revisions will be deemed to supersede the appropriate Part 1910 and Part 1926, and be effective as of the date set forth in the revised regulation.

The Contractor's attention is directed to RSA Chapter 277, Safety and Health of Employees, which among other provisions, states rules regarding elevators and scaffolding at construction sites.

In protecting employees from hazardous or toxic exposure, RSA Chapter 277-A, Toxic Substances In The Workplace, states that the employees have the right to know of possible toxic substances in the workplace, and RSA 277-A:5, in part, states that employers shall inform employees as to possible contact with toxic materials and conduct education and training programs.

#### **107.06 Public Convenience and Safety.**

Construction shall be conducted in a manner so that obstructions to traffic are minimized. The safety and convenience of the public and the protection of persons and property shall be provided as specified under [104.03](#). The safety provisions of all laws, rules, codes, and regulations applicable to the class of work being performed shall be followed.

No footways, gutters, sewer inlets, or portions of highways adjoining the highway under construction shall be obstructed more than is necessary. Fire hydrants and water holes for fire protection on or adjacent to the highway shall be kept accessible to the fire apparatus at all times and no obstructions shall be placed within ten feet of any such facility. The Contractor shall be responsible for proper and timely notification to local residents prior to any interruptions of their access or services. In the event that all or part of the highway is officially closed to traffic during construction, the Contractor shall provide and maintain safe and adequate traffic accommodations for residences and businesses along and adjacent to the highway so closed.

Except for work done under items in the Contract, work prescribed herein will not be paid for separately but will be considered as subsidiary.

#### **107.07 Barricades and Warning Signs.**

The Contractor shall provide, erect, and maintain barriers, barricades, lights, signals, signs, and other traffic control devices, and shall take all necessary precautions for the protection of the Work and safety of the public. Highway sections closed to traffic shall be protected by effective barriers and barricades. Obstructions shall be illuminated during darkness. Warning signs shall be provided to control and direct traffic.

The Contractor shall erect warning signs in advance of operations that may interfere with the use of the road by traffic and where the new work crosses or coincides with an existing road. Warning signs shall be placed according to the Traffic Control Plan and maintained in accordance with the Contract. Signs, barriers, barricades, lights, or other protective devices shall not be dismantled or removed without permission of the Engineer.

The Contractor will be held responsible for all damage to the Work from traffic, pedestrians, animals, or any other cause due to lack of adequate protective devices.

All barricades, warning signs, lights, temporary signals, and other protective devices shall conform with the MUTCD and [Section 619](#).

#### **107.08 Use of Explosives.**

All laws, ordinances, and regulations, including the rules of the Director of State Police as well as Part 1926 - Safety and Health Regulations for Construction (OSHA) of Title 29 of the Code of Federal Regulations and the appropriate parts of Title 30, whichever is the most restrictive, shall be followed in the use, handling, loading, transporting, and storing of explosives and blasting agents.

The Contractor's attention is called to RSA Chapter 158, which gives the Director of the Division of State Police the authority to regulate the sale, storage, handling, transportation, inspection, administration, and use of explosives or explosive substances.

Explosives used in the prosecution of the Work shall not endanger life, property, or new work. The Contractor shall be liable for all property damage, injury, or death resulting from the use of explosives.

The Contractor shall notify each property owner and public utility company having structures or facilities close to the Work of any intention to use explosives. The notice shall be given sufficiently in advance to enable the owners to protect their property.

All explosives shall be stored in a secure manner. All storage places shall be clearly marked. Explosives shall be stored in a magazine which shall be located in respect to buildings, railways, and highways in a manner as required by the Director of State Police.

Explosives shall be used only during daylight hours, shall be handled only by competent workers, and particular care shall be taken to ensure that no unexploded charges remain in the Work.

All persons within the danger zone of blasting operations as determined by the blasting Contractor (per [203.3](#)) shall be warned and no blasting shall be done until the zone has been cleared. Sufficient flaggers shall be stationed outside the danger zone to stop all approaching traffic during blasting operations.

#### **107.09 Protection and Restoration of Property and Landscape.**

Public and private property shall be preserved in the prosecution of the Work. Land monuments and property markers shall not be moved, disturbed, or damaged until the Engineer has witnessed or referenced their location.

The Contractor is responsible for damage to public and private property resulting from any act, omission, neglect, misconduct in the Contractor's method of executing the work, defective work or materials, or failure to perform the Contract. This responsibility shall not be released until Completion and Acceptance.

## SECTION 107

Damaged property shall be restored to a condition similar or equal to that existing before the damage or injury occurred. The repairing, restoring, rebuilding, or making good of such damage or injury shall be at the Contractor's expense.

If the Contractor fails to repair, restore, rebuild, or make good such damage or injury, the Engineer, after 48 hours' notice, may proceed to do so, and the cost thereof will be deducted from any money due or which may become due the Contractor under the Contract.

### 107.09.1 Cultural Resources.

When construction operations encounter possible historic or potential Native American artifacts of archeological significance, operations shall be immediately suspended in the area and the Engineer notified. The Engineer will contact the Department's Cultural Resource Manager (603-271-3226) and the State archaeologist who with the Project Manager will determine the disposition of the site. It may be necessary for others to conduct investigations to determine the extent of importance of the site and to recover the remains prior to commencement of the project within the defined boundaries of the site. Compensation and time extensions for this work shall be determined in accordance with 104.02.

When construction operations encounter human remains, operations in the immediate area shall be temporarily discontinued and the Contractor shall notify the Engineer who will notify state and local police and the Department's Cultural Resource Manager. The County Medical Examiner will determine whether the remains require a criminal or archaeological investigation. A buffer zone will be defined for the burial sites; no work will be performed within that zone until after removal of the remains by others. The Contractor will be directed to continue work in the area when the investigation is completed. Compensation and time extensions for this work shall be determined in accordance with 104.02.

The Contractor shall maintain a 25-foot buffer zone around known cemeteries. If the Contract specifies work within this buffer zone or cemetery, contact the NHDOT Cultural Resource Manager two (2) weeks prior to beginning work in that area. The Contractor's attention is directed to RSA 227-C:8 a-g, RSA 290, RSA 635, and Federal Regulations 36-CFR-800 dealing with cemeteries and human remains.

### 107.10 Forest Protection.

Work within or adjacent to State or National Forests shall be accomplished under the rules and regulations of the State Fire Marshal, State Forest Fire Control Supervisor, Department of Resources and Economic Development, Department of Fish and Game, National Forest Supervisor, or other authority having jurisdiction governing the protection of forests. Sanitary laws and regulations regarding the performance of work within or adjacent to State or National Forests must be obeyed. The Contractor shall keep the project site in an orderly condition, dispose of all refuse, and obtain permits for the construction and maintenance of all construction camps, stores, warehouses, residences, latrines, cesspools, septic tanks, and other structures in accordance with the regulations and instructions issued by the Forest Supervisor.

Forest fires shall be prevented and suppressed. The Contractor shall require employees and Subcontractors, both independently and at the request of forest officials, to prevent and suppress and to assist in preventing and suppressing forest fires and to notify a forest official of the location and extent of any fire. The requirements as to burning are as follows:

No open burning shall be done by the Contractor without advance written approval from the New Hampshire Department of Environmental Services, Air Resources Division (see 107.01). The Contractor shall abide by such rules and directions as are prescribed by the local forest fire warden or the forest ranger of the New Hampshire Department of Resources and Economic Development, Division of Forest and Lands, or both.

### 107.11 Responsibility for Damage Claims.

The Contractor shall indemnify, defend, and save-harmless the State; adjoining states, cities, or towns; the railroad where operations will affect railroad property; and all of their officers, agents, and employees from and against any and all claims, liabilities, suits, or penalties arising out of (or which may be claimed to arise out of) acts or omissions of the Contractor or Subcontractors in the performance of work covered by the Contract. This responsibility shall survive the termination of the Contract. Notwithstanding the foregoing, nothing herein contained shall be deemed to constitute a waiver of the sovereign immunity of the State, which immunity is hereby reserved by the State.

- A. Liability insurance for damages imposed by law of the kinds and amounts specified herein shall be obtained and maintained by the Contractor. The insurance obtained shall cover all operations under the Contract whether performed by the Contractor or Subcontractor of any tier and shall be maintained until Acceptance.
- B. Before submittal of the Contract to Governor and Executive Council for approval, certificates of insurance in the standard form employed in the State of New Hampshire by underwriters licensed or approved by the Department of Insurance shall be furnished evidencing the required coverages and conditions. In addition, the underwriters must have a rating of no less than B+ based on the current A.M. Best rating guide. The Contractor shall have a continuing duty to provide new certificates of insurance as policies are amended or renewed. The minimum required insurance coverages and conditions are as follows:

1. Workers' Compensation and employers liability as required by law.

Limits of Liability: \$100,000 each accident;  
 \$500,000 disease - policy limit;  
 \$100,000 disease - each employee.

Deductible, if applicable, to be shown on certificate.

2. Commercial General Liability; Occurrence Form, to include Contractual Liability (see Indemnification Clause), Explosion, Collapse and Underground coverages.

Limits of Liability: \$1,000,000 Each Occurrence Bodily Injury & Property Damage;  
 \$2,000,000 General Aggregate-Include Per Project Aggregate Endorsement;  
 \$2,000,000 Products/Completed Operations Aggregate; or

Comprehensive General Liability Form; to include Premises/Operations, Independent Contractors, Products/Completed Operations, Personal Injury, Contractual Liability (see Indemnification Clause), Collapse and Underground, Medical Payment coverages (Broad Form Comprehensive GL Endorsement)

\$1,000,000 Combined Single Limit of Liability for Bodily Injury & Property Damage.

Note: If blasting or demolition or both is required by the Contract, the Contractor or Subcontractor shall obtain the respective coverage and shall furnish to the Engineer a Certificate of Insurance evidencing the required coverages prior to commencement of any operations involving blasting or demolition or both.

3. Owner's Protective Liability Coverage for the benefit of the State of New Hampshire Department of Transportation.

Limits of Liability: \$2,000,000 Each Occurrence;  
 \$3,000,000 Aggregate.

or \$2,000,000 Bodily Injury & Property Damage per occurrence (1973 form).

4. Comprehensive Automobile Liability covering all motor vehicles including owned, hired, borrowed and non-owned vehicles.

Limits of Liability: \$1,000,000 Combined Single Limit for Bodily Injury & Property Damage.

5. Commercial Umbrella Liability

Limits of Liability: \$1,000,000 Each Occurrence;  
 \$1,000,000 Aggregate.

6. Railroad Protective Liability if the Contract involves work on, over, under or within 20 feet of the right-of-way of the railroad, on behalf of and payable to the railroad company and, if applicable, to the owner of the railroad corridor specified in the Prosecution of Work. Combined Single Limit of Liability for Bodily Injury and Property Damage.

Limits of Liability: \$2,000,000 per Occurrence;  
 \$6,000,000 Aggregate

7. General Insurance Conditions

- (a) Each policy shall contain a clause prohibiting cancellation or modifications of the policy earlier than 30 days, or 10 days in cases of non-payment of premium, after written notice thereof has been received by the Department.

8. Builder's Risk Insurance: The Contractor shall insure the work included in the Contract on an "All Risk" basis, on one hundred percent (100%) completed value basis of all building construction. This coverage shall specifically insure all landscape plantings on a one hundred percent (100%) completed value basis. Coverage need not include work involving parking areas, driveways, roads or bridges. Builder's Risk coverage shall include materials located on-site, in-transit, and at any temporary site. The policy by its own terms or by endorsement shall specifically permit partial or beneficiary occupancy prior to completion or acceptance of the entire work. The policies shall be in the names of the State Agency and the Contractor. The policies shall provide for the inclusion of the names of all other Contractors, Subcontractors, and others employed on the premises as insureds. The policies shall stipulate that the insurance companies shall have no right of subrogation against any Contractors, Subcontractors or other parties employed on the premises.

9. Additional types of coverage may be established and required in the Proposal.

## SECTION 107

Insurance requirements described above shall be the responsibility of the Contractor. The Contractor may require Subcontractors to maintain similar coverage.

### **107.12 No Third Party Beneficiary.**

It is specifically agreed between the parties executing this Contract that it is not intended by the Contract provisions to make the public or any member thereof a third party beneficiary hereunder, or to authorize anyone not a party to the Contract to maintain a suit for personal injuries or property damage pursuant to the terms or provisions of the Contract. The duties, obligations, and responsibilities of the parties to this Contract with respect to third parties shall remain as imposed by law.

### **107.13 Personal Liability of Public Officials.**

The Department's authorized representatives are acting solely as agents and representatives of the Department when carrying out and exercising the power or authority granted to them under the Contract. There shall not be any liability either personally or as employees of the Department. No part of this Contract shall be understood to waive the sovereign immunity of the State.

### **107.14 No Waiver of Legal Rights.**

Acceptance will not prevent the Department from correcting any measurement, estimate, or certificate made before or after completion of the Contract. The Department will not be prevented from recovering, from the Contractor or Surety or both, overpayments sustained for failure to fulfill the obligations under the Contract. A waiver on the part of the Department of any breach of any part of the Contract shall not be held to be a waiver of any other or subsequent breach.

The Contractor is liable to the Department for latent defects, fraud or such gross mistakes as may amount to fraud, or as regards the Department's rights under any warranty or guaranty without prejudice to the terms of the Contract.

### **107.15 Civil Rights.**

The Contractor shall comply with Federal, State and local laws, rules, and regulations that set forth unlawful employment practices including that of discrimination because of race, religion, color, sex, or national origin, and that define actions required for Affirmative Action and Disadvantaged Business Enterprise programs.

### **107.16 Assignment Provision.**

The Contractor hereby agrees that it will assign to the State all causes of action that it may acquire under the antitrust laws of New Hampshire and the United States as the result of conspiracies, combinations, or Contracts in restraint of trade which affect the price of goods or services obtained by the State under this Contract if so requested by the State.

### **107.17 Hazardous Materials.**

The Contractor shall be aware of laws and regulations relating to hazardous materials that may be encountered during construction operations, either within project limits or at material sites off the project. The health and safety of employees, the general public, and the potential for damage to the overall environment is possible if hazardous materials are not recognized, reported, and the appropriate action taken to dispose of, remove from the site, or otherwise contain the possible contaminants.

State laws such as RSA141-E, Asbestos Management and Control, RSA 147-A, Hazardous Waste Management, and RSA 149-M, Solid Waste Management, identify the major areas of concern. Parts Env-Wm 100-110, Env-Wm 101-300, 2100-3700, and Env-Wm 3900 of the New Hampshire Code of Administrative Rules identify various contaminants related to hazardous waste, solid waste, and asbestos and their management, respectively.

If any abnormal condition is encountered or exposed that indicates the presence of a hazardous material or toxic waste, construction operations shall be immediately suspended in the area and the Engineer notified. No further work shall be conducted in the area of the contaminated material until the site has been investigated and the Department has given approval to continue the work in the area. The Contractor shall fully cooperate with the Engineer and perform any remedial work as directed. Work shall continue in other areas of the Project unless otherwise directed.

Exposure to hazardous materials may result from contact with, but not necessarily limited to, such items as drums, barrels, other containers, and waste such as cars, batteries, and building construction debris. Containers leaking unknown chemicals or liquids, abandoned cars leaking petroleum products, batteries leaking acid, construction debris that may include asbestos, or any other source of suspected hazardous material found within excavation areas or stockpiled on land within construction limits shall be referred to the Department of Environmental Services so that a proper identification of the materials may be made and disposal procedures initiated as required.

Disposition of the hazardous material or toxic waste shall be made under the requirements and regulations of the Department of Environmental Services. Work required to dispose of these materials shall be performed under Contract item(s), or Supplemental Agreement; compensation and time adjustment shall be as provided for in 104.02. If the waste material disposal requires special procedures, the Department will make arrangements to dispose of the material.



**SECTION 108 -- PROSECUTION AND PROGRESS****108.01 Subletting of Contract.**

The Contractor shall not sublet, sell, transfer, assign, or dispose of any portion of the Contract or Contracts without written consent of the Department. The Contractor's organization shall perform work amounting to not less than 50 percent of the Contract Amount unless a higher percentage is specified in the Contract. Items designated in the Contract as "specialty items" may be subcontracted and the cost of specialty items performed by subcontract may be deducted from the Contract Amount before computing the amount of work required to be performed by the Contractor's own organization. Any subcontracts, or transfer of Contract, shall not relieve the Contractor, or its Surety of liability under the Contract and Bonds.

For proposed Subcontractor or lower-tier Subcontractor approval, the Contractor shall file all required forms and a copy of the executed subcontract with the Bureau administering the Contract at least five working days prior to the requested subcontract work being started. Retroactive subcontract or lower-tier subcontract agreements will not be allowed.

In accordance with New Hampshire law (RSA 228:4-b), prior to any on-site work being performed on any highway, bridge, or other construction, reconstruction, alteration, or maintenance project funded by the Department, each Contractor, Subcontractor, lower-tier Subcontractor, must submit a "Work Certificate" with supporting documentation and obtain approval from the Bureau administering the project.

The Contractor shall not knowingly sublet, sell, transfer, assign, or dispose of any portion of the Contract or Contracts with any person or entity which, under any federal or state law or regulation, or by voluntary agreement, is currently debarred or disqualified from bidding for construction Contracts or participating in construction projects in any jurisdiction of the United States, unless after disclosure of such ineligibility, such participation is authorized by appropriate federal and State authorities, including the Engineer. No payment will be made for work performed by any such Contractor.

Transmittal requests (OFC Form 15) shall indicate either subcontract work or lower-tier subcontract work and shall include a copy of the subcontract agreement attached to a certification that all required Contract provisions, notices and report forms are a part of each subcontract.

If, during the course of the Work, a Subcontractor or lower-tier Subcontractor fails to complete or perform satisfactory work, the Contractor shall complete the Work itself or with another approved Subcontractor. The Contractor shall not substitute another Subcontractor for an approved Subcontractor except for reasons acceptable to the Department, nor shall an approved Subcontractor be allowed to perform work not prescribed in the executed agreement on file without prior consent by the Department.

No payment will be made for work performed by any Subcontractor, lower-tier Subcontractor, or Independent Contractor performing work without consent by the Department. Consent will be contingent upon submittal of all required forms including a "Work Certificate". Any Subcontractor, lower-tier Subcontractor, or Independent Contractor that fails to comply with this requirement may be reported to the New Hampshire Department of Labor for review under RSA 228:4-b.

**108.02 Notice to Proceed.**

The Notice to Proceed will stipulate the date on which it is expected the Contractor will begin the construction and the date from which Contract Time will be charged. Commencement of work by the Contractor, prior to the Notice to Proceed, shall constitute the beginning of construction and the date from which Contract Time will be charged.

**108.03 Pre-Construction Activities.**

Prior to commencement of any major work on the Project, a pre-construction conference shall be held to review the proposed project schedule and coordinate the Work of the Contractor, utilities, and Subcontractors. The Contractor shall be prepared to discuss in detail the proposed schedule; the [Storm Water Pollution Prevention Plan \(SWPPP\)](#), and the Traffic Control Plan particularly as these relate to coordination with schedules of the utilities and Subcontractors. In addition, the Contractor shall be prepared to provide details on the sources and delivery of materials.

If required the Contractor shall submit a written SWPPP and Traffic Control Plan to the Engineer for approval in accordance with [105.02](#).

The Contractor shall submit a Progress Schedule to the Engineer for documentation in accordance with [105.02](#); the Engineer reserves the right to return the Progress Schedule for revision based on the form, compliance with the Contract and good scheduling practice. No work shall proceed on the project, other than mobilizing, installation of the permanent construction signs, and installing the field office, until the Progress schedule has been submitted and accepted for documentation.

The Progress Schedule submission shall include at a minimum a paper copy and an electronic file. The New Hampshire Department of Transportation has adopted Microsoft Project Scheduler as the official Department scheduling software. All electronic submissions shall be compatible with MS Project.

## SECTION 108

### A. Progress Schedule

#### A.1 General.

Plan and schedule the project and provide sufficient materials, equipment, and labor to guarantee completion of the project within the Contract Time. Provide a schedule using the Critical Path Method as specified in Subsection 108.03.A.2, except when the Contract specifies a schedule using the Bar Chart Method, in which case, the schedule shall meet the requirements of Subsection 108.03.A.3. If a bar chart is specified, the Contractor may provide a CPM schedule in place of the bar chart schedule.

**A.1.1** Prosecute the work according to the schedule and ensure that all Subcontractors, and suppliers at any tier; also prosecute the Work according to the Progress schedule. The Progress schedule shall show major construction activities, project phasing, critical activities, project required milestones, activity durations by working day or calendar day, and project suspensions that are 3 days or longer. Major activities shall include activities such as installation of cofferdam, excavate bridge footing, pave top at areas designated, etc. Subcontractor work, utility relocation work, submission of any working drawings including the review periods indicated in 105.02 for each submission, and manufacturing of key components shall be included as major activities. The schedule shall also include the proposed utility relocation schedule as outlined in the Prosecution of Work. Critical activities shall be those activities that, if delayed, would delay the scheduled project completion date. Milestones shall include the start date of the project, winter suspensions if planned, project intermediate, and final project completion dates. All work shall be scheduled to be completed by or prior to project required milestones. The Contractor is not entitled to a time extension or compensation for the delay except as explicitly allowed by 104.02, 105.18, 108.07, and 109.04.

**A.1.2** At least 10 calendar days before the preconstruction meeting, submit to the Engineer for review an initial Progress schedule that meets the requirements specified in Subsection 108.03.A.2 or 108.03.A.3, as applicable. The Engineer and Contractor will review the initial schedule at the preconstruction meeting. Within 5 working days after the preconstruction meeting, the Engineer will accept the Contractor's initial schedule or request additional information. The type of information requested may include estimated manpower, equipment, unit quantities, and production rates used to determine the duration of an activity or item of work. Provide the requested information and resubmit the revised initial schedule within 5 working days after receiving the Engineer's request.

**A.1.3** The Engineer will use the schedule to monitor the progress of the work. The Engineer will accept for documentation or return the initial Progress Schedule based solely compliance with the Contract and good scheduling practice. Acceptance does not modify the Contract or constitute endorsement or validation by the Engineer of the Contractor's logic, activity durations, or assumptions in creating the schedule or relieve the Contractor of the obligation to complete the Contract Work within the Contract Time. The Department may withhold monthly progress payments until the Engineer accepts the initial Progress Schedule.

**A.1.4** Submit a schedule update to the Engineer on the first working day of each month, or as requested by the Engineer. The Department may withhold monthly progress payments if schedules are not updated as specified or requested. The Contractor shall participate in the Engineer's review of the submittals. Meetings will be held to review progress and planning when requested by the Engineer

**A.1.5** All costs relating to the preparation, submittal, and acceptance of the schedule, reports and revisions, and all requirements of this subsection are subsidiary to Contract bid items.

#### A.2 Critical Path Method (CPM).

Use either Microsoft Project or Primavera Scheduling software to develop and manage the Critical Path Schedule. The Contractor shall notify the Engineer in writing, when submitting the first schedule, which software will be used. This choice cannot be changed after the first submittal. When the Contractor uses Primavera scheduling software, an electronic file of all required schedule and reports converted to the Microsoft Project format on acceptable media, shall be submitted. This additional information shall be submitted with all schedule submittals and updates. Perform all work required to ensure that the schedule accurately reflects the planned schedule and progress. Microsoft Project scheduling software shall be provided by the Contractor for the duration of the project for use by the Contract Administrator.

**A.2.1 Initial Work Plan.** Submit before work begins a schedule for the first 60 calendar days of work that meets the requirements for an initial bar chart as specified in Subsection 108.03.A.3.1. With prior approval, the Engineer may accept activity durations of more than 15 working days. Include a summary bar chart schedule for the balance of the project; activity durations on the summary chart may exceed 15 working days. Submit an updated version of the bar chart every 14 calendar days, until the Department accepts the initial CPM schedule. An Initial CPM Schedule in accordance with A.2.2 may be submitted in place of the bar chart.

**A.2.2 Initial CPM Schedule.** Within 30 calendar days after providing the initial bar chart, submit an initial CPM schedule to the Engineer for review. Define and sequence activities so as to accurately describe the project and to meet Contract requirements with respect to the scope of work, phasing, accommodations for traffic, and interim, milestone, and project completion dates. Use working days to create the schedule, beginning with the date of the notice to proceed or the date the Contractor began the work, whichever date is earlier.

**A.2.2.1 CPM Schedule Requirements.** Ensure that the CPM schedule identifies and includes the following:

- (a) Planned start and finish dates for each activity;

- (b) Duration of each activity in work days, and with activities of more than 15 work days in duration broken into two or more activities distinguished by location or some other feature;
- (c) Finish-to-start relationships among activities, without leads or lags, unless otherwise approved by the Engineer;
- (d) Interim, milestone, and project completion dates specified in the Contract as the only constraints in the schedule logic;
- (e) Activities related to the procurement of critical materials, equipment, and articles of special manufacture;
- (f) Activities related to the submission of working drawings, plans, and other data specified for review or approval by the Engineer;
- (g) Activities related to Department inspections; and
- (h) Activities related to specified activities by the Department or third parties.

**A.2.2.2 CPM Schedule Submission Requirements.** Provide the following items with each schedule submission. Submit 1 paper copy and 1 electronic file of the schedule to the Engineer. The Contractor shall include the following in the paper submission:

- (a) A logic diagram in color, depicting no more than 50 activities on each 11" by 17" sheet, and with each sheet including title, match data for diagram correlation, and a key.
- (b) Tabular sorts of activities by early start, predecessor and successor, work area by early start, longest path, and total float;
- (c) 60-day look-ahead bar charts by early start; and a
- (d) Narrative report indicating the workdays per week, holidays, number of shifts per day, number of hours per shift, and how the schedule accommodates adverse weather days for each month.

**A.2.2.3 Schedule Updates.** Update the schedule on a monthly basis, or as requested by the Department, to show current progress. Include the following with each update:

- (a) Actual start and finish dates of each activity or remaining durations of activities started but not yet completed; and
- (b) Narrative report describing progress during the month, shifts in the critical activities from the previous update, sources of delay, potential problem areas, work planned for the next update period, and changes made to the CPM schedule. Changes include additions, deletions, or revisions to activities due to the issuance of a Contract Revision, changes to an activity duration, changes to relationships between activities, or changes to the planned sequence of work or the method and manner of its performance.
- (c) The updated schedule shall show completion of the Work within the Contract Time and the Contractor shall modify operations to provide such additional materials, equipment, and labor necessary to meet the updated schedule unless the Contract Time has been extended per 108.07.
- (d) Notify the Engineer at least three working days in advance of resuming operations when the prosecution of work is discontinued for any reason.
- (e) Submit the updated schedule electronically to the Engineer. Also provide 1 paper copy of tabular sorts by total float, longest path, and activity by early start.

### **A.3 Bar Chart Method. Use this scheduling method when specified.**

**A.3.1 Initial Bar Chart Progress Schedule.** The initial bar chart Progress schedule shall include the following:

- (a) Activities that describe the essential features of the work, activities that might delay Contract completion, and other critical activities;
- (b) The planned start and completion dates for each activity, the duration of each activity (stated in work days, and with activities of more than 15 work days in duration broken into two or more activities distinguished by location or some other feature), and the sequencing of all activities;
- (c) For Contracts without weather day allowances, the Contractor shall provide a written indication of how the schedule accommodates adverse weather days for each month;
- (d) Activities related to the procurement of significant materials, equipment, and articles of special manufacture;
- (e) Dates related to the submission of working drawings, plans, and other data specified for review or approval by the Agency;
- (f) Dates related to Department inspections; and
- (g) Dates related to specified activities by the Department and third parties.

**A.3.2 Project Schedule Updates.** Conduct job site meetings with the Engineer to verify schedule accuracy. Hold meetings monthly or as required by the complexity of the project. Update the schedule as required to reflect actual work modifications and progress and to document approved Contract Revisions, including all time extensions. Include the actual start and finish of each activity, percentage complete, and the remaining duration of activities started and still ongoing. Submit [2] copies of the schedule update to the Engineer for review within 72 hours of the job site meeting.

## SECTION 108

### A.4 Schedule Revisions.

The Engineer may request a revised schedule. Circumstances that may lead to such a request include the following:

- (a) A delay (actual or projected) to scheduled milestone or project completion dates;
- (b) A difference between the actual sequence or duration of work and that depicted in the schedule; and
- (c) Issuance of a Contract Revision that, by adding, deleting, or revising activities, changes the planned sequence of work or the method and manner of its performance.

Prepare and submit the revised schedule within 10 calendar days after the Engineer's request. Within 10 calendar days of receipt, the Engineer will accept the revised schedule, reject the revised schedule, or request additional information. Address the reasons for rejection and submit the information requested no more than 10 calendar days after the Engineer's request.

### B. Storm Water Pollution Prevention Plan (SWPPP).

The SWPPP shall detail the methods planned for accomplishment of temporary and permanent erosion control work for operations including, but not limited to, clearing, grubbing, grading, drainage, and bridge operations, especially in or adjacent to existing waters, water courses, or wetlands. The SWPPP shall include proposed methods of erosion control for haul roads, borrow pits, and disposal areas.

### C. Traffic Control Plan.

The traffic control plan shall include the Contractor's detailed plan for controlling traffic through the Project and shall be in conformance with the MUTCD and other applicable standards. This plan shall include specific design details on lane closures, detours, and temporary bridges. The plan shall also include the layout of signing, barricades, and other warning devices, as well as the placement of flaggers and uniformed officers. If the Contractor does not submit a traffic control plan for approval, it will be presumed that the Contractor plans to adhere to the Traffic Control Plan contained in the Contract. Changes to the approved traffic control plan shall be submitted to the Engineer for review and approval at least fifteen working days in advance of implementation of the change.

#### 108.04 Limitation of Operations.

Construction operations shall be conducted to ensure the least interference with traffic, with due regard to the location of detours and to the provisions for handling traffic. The Engineer may require the Contractor to finish a portion of the Project before work is started on any additional portions of the Project if the opening of such portion is essential to public needs.

No work shall be performed on Sundays or legal holidays as defined in [Section 101](#) or without the written permission of the Engineer except in cases of emergency. Whenever a holiday is observed on a Friday or a Monday, the Contractor may be required to suspend work for three days. Prior to the close of work, the Project shall be placed in the best condition possible for the comfort and safety of the traveling public, and definite arrangements shall be made for responsible personnel to maintain the Project in the above condition throughout the period of time when work is not being performed. No work will be permitted at night unless sufficient lighting is provided to ensure a comparable degree of accuracy, workmanship, and conditions regarding safety as would be obtained in daylight.

#### 108.05 Character of Workers.

The Contractor shall employ sufficient resources for prosecuting all classes of work in the manner and time required by the Contract.

Workers shall have sufficient skill and experience to properly perform their assigned work. Workers engaged in work requiring special skills shall be sufficiently knowledgeable and experienced in the work and in the operation of the equipment required to perform the work satisfactorily.

Any person employed by the Contractor or by any Subcontractor who, in the opinion of the Engineer, does not perform the Work in a proper and skillful manner or is intemperate or disorderly shall, at the written request of the Engineer, be removed from the Work, and shall not be employed again in any portion of the Work without the approval of the Engineer.

Should the Contractor or Subcontractor fail to remove the person or persons or fail to furnish suitable and sufficient personnel for the proper prosecution of the Work, the Work may be suspended by written notice until the Engineer's orders are followed. The Contractor is not entitled to a time extension or compensation for delays or costs incurred as a result of such a suspension.

#### 108.06 Methods and Equipment.

All equipment used on the Project shall be of sufficient size and mechanical condition to meet the requirements of the Work and to produce work of satisfactory quality. Equipment used shall not cause injury to the roadway, adjacent property, or other highways.

If equipment used by the Contractor or Subcontractor, proves inadequate to obtain the results prescribed by the Contract, the Engineer may order said equipment to be improved or other equipment substituted or added.

When the methods and equipment to be used by the Contractor in accomplishing the construction are not prescribed in the Contract, the Contractor is free to use any methods or equipment that will accomplish the Work that meets the Contract requirements.

Where practicable, spray applications of materials containing fertilizer, asphalt, and other injurious substances which cause pitting or which impair the reflective and brightness values of metal shall precede the installation of susceptible roadside structures such as signs, sign supports, and guardrail; otherwise, coverings shall be used to protect such structures installed prior to the spray applications.

Failure on the part of the Contractor to observe the necessary precautions to prevent damage to property; injury to persons; or the runoff of fuels, oils, bitumens, or other polluting materials into surface and ground waters (in accordance with RSA 146-A) shall be sufficient grounds for suspension of the Work. The Contractor is not entitled to a time extension or compensation for such suspensions.

When the methods and equipment to be used are specified, other methods and equipment shall not be used unless requested in writing by the Contractor and approved by the Engineer. The request shall include a description of the methods and equipment proposed and the reasons for making the change. If approval is given, the Contractor shall be responsible for producing work meeting the Contract requirements. If the Engineer determines that the work produced does not meet the Contract requirements, the use of the substitute methods or equipment shall be discontinued and the remaining Work shall be completed with the specified methods and equipment. Deficient work shall be removed and replaced or repaired to the specified quality by and at the Contractor's expense. The Contractor is not entitled to a time extension or compensation for an approved change in methods or equipment.

### **108.07 Determination of Contract Time Extension for Excusable, Nonexcusable, Noncompensable, and Compensable Delays.**

#### **A. General.**

The number of days allowed for completion of the Work or the completion date will be stated in the Proposal and Contract. It is an essential part of the Contract that the Contractor performs fully, entirely, and in an acceptable manner, the Work under the Contract within the Contract Time. It is likewise essential that those parts, phases, or stages, as stipulated in the Contract, for the purpose of benefiting the traveling public or for the coordination of work performed by others, shall be completed by the date indicated. An extension of the Contract Time may be granted by the Department for conditions that prevent the Contractor from effective prosecution of the critical activity which at that time control the progress of the work as specified in 108.07.B or 108.07.C. Strict adherence to the provisions of this section is necessary for the Engineer's consideration of an extension to the Contract Time.

The Engineer will not evaluate a request for extension of the Contract Time unless the Contractor notifies the Engineer as specified in 104.02.G, provides the required analysis as specified in 108.03.A.4, and further provides the documentation to the Contract Administrator as specified in 108.07.G and H. It is the intention of the Department to act to mitigate or grant time extensions for delays before the delay is actually experienced by the project. For this reason, the Contractor shall provide proper notice of a delay per 104.02.G when it is first recognized, not at its conclusion. The Contractor's contention that it did not know the actual duration of the delay is not a valid excuse for failing to comply with the notice requirements of 104.02.G. However, if the Contractor requests in writing and the Engineer agrees, the Engineer may extend the deadlines set forth in 104.02.G.

The Engineer will evaluate the Contractor's analysis and determine the time extension due, if any.

The Contractor's plea that insufficient time was specified is not a valid reason for an extension of time. When the Contract sets forth a calendar completion date, due consideration will have been given to the Saturdays, Sundays, legal holidays, and the period between December 1 and April 1 inclusive in the anticipated period of construction. No extension of the Contract completion date will be allowed due to such days. When the Contract stipulates a completion date that falls on a Saturday, Sunday, or legal holiday, or when the time as extended by the Engineer falls on a date that is a Saturday, Sunday, or legal holiday, the Contract Time will be extended to the next working day.

The extended Completion Date shall have the same standing and effect as though it was the original Completion Date.

If the Contractor contends that an excusable delay is also compensable, as specified in 108.07.C, the Contractor shall submit a detailed cost analysis of the requested additional compensation prepared in accordance with 109.04 along with the request for the extension of the Completion Date.

In the event that the Engineer extends the Contract Time into a period of the year during which the working conditions are less favorable, consideration will be given to further extension of time as influenced by the nature of the work involved.

If the Contract Time or phase of work as established in the Contract is based on working days, the Engineer will furnish a weekly statement showing the number of working days charged for the preceding week and the number of working days remaining for completion of the Contract. The Contractor will be allowed 5 working days after the Engineer issues the weekly statement to file a written protest setting forth the reasons the Engineer's weekly statement is incorrect, otherwise the statement will be considered accepted by the Contractor. Once accepted by the Contractor, whether explicitly or as a result of the Contractor's failure to file a timely protest the weekly statement is final and the Contractor waives entitlement to a time extension or

## SECTION 108

compensation for any delays not explicitly identified by the weekly statement. An increase of quantities will increase the number of allowable working days by the ratio of the final Contract Total to the original Contract Amount (Total).

### **B. Excusable, Noncompensable Delay.**

Excusable, non-compensable delays are delays that are not the Contractor's or the Department's fault or responsibility. The Contractor is not entitled to compensation for excusable, non-compensable delays.

The following are excusable, non-compensable delays:

1. Delays due to floods, tornadoes, lightning strikes, earthquakes, or other natural disasters.
2. Delays due to unfavorable weather or ground conditions on days, other than the days from December 1 through April 1, determined as follows: for each day on which weather or ground conditions prevent the Contractor from effective prosecution of the critical activity that at that time controls the progress of the work, an extension of one working day will be added to the Contract Time. The Engineer will not consider weekends and holidays as lost work days unless the Engineer directs the Contractor to work those days.
3. Extraordinary delays in material deliveries the Contractor or its suppliers cannot foresee or avoid resulting from freight embargoes, government acts, or nation-wide material shortages. When an extension of the Contract Time is requested due to delays in the delivery of critical materials, sufficient documentary evidence must be furnished to the Department at the time the delay occurs showing that such delay results from the materials being unavailable by reason of an unusual market condition such as an industry-wide strike, natural disaster, or area-wide shortage which arises after bids are taken and which prevents the timely procurement of materials. The Contractor is not due a time extension for delays due to slow delivery from a source of supply when the required material is available elsewhere. Delays due to the Contractor's, Subcontractor's, or supplier's insolvency or mismanagement are not excusable.
4. Delays due to the failure of the Department to provide right-of-way in accordance with the Contract.
5. Delays due to civil disturbances or acts of the public enemy.
6. Delays due to fires.
7. Delays due to epidemics or quarantine restrictions.
8. Delays from labor strikes that are beyond the control of the Contractor's, Subcontractor's, or supplier's and are not caused by improper acts or omissions of the Contractor, Subcontractor, or supplier.
9. Delays due to added quantities of work or Extra Work. The Department will base the time extension on the ratio of the original bid amount to the final Contract amount, computed as follows:

$$TE = \frac{(TC - CA) OT}{CA}$$

*TE* is the time extension in working days (rounded to the next highest whole day);

*OT* is the original Contract time in working days. This time does not include time added by Contract Revisions or Saturdays, Sundays, legal holidays, and the period between December 1 and April 1;

*TC* is the total cost of the work performed, including cost increases resulting from Extra Work for which a time extension was not previously provided; and the net increase or decrease in the Contract amount resulting from the performance of greater or lesser quantities for which an extension was not previously provided; and excluding costs associated with liquidated damages, incentive/disincentive or bonus payments, and costs for Contract Revisions for which additional time has already been allowed;

*CA* is the original Contract Amount.

To determine a revised completion date, the Department will add the working days indicated by the formula to the original Contract completion date.

If the Contractor believes that this formula does not result in a fair and reasonable time extension for Extra Work or for increased quantities, as an alternative, but not in addition, to the formula, the Contractor may submit an alternative analysis based on the delay to the critical path of the Progress schedule accepted for documentation caused by the Extra Work or additional quantities. The Contractor's analysis must consider not only the work added, but also the work deleted in its analysis.

10. Delays due to utility or Railroad relocations or any other Railroad coordination delays.
11. Delays due to an emergency episode procedure carried out under the direction of the New Hampshire Department of Environmental Services, Division of Air Resources.
12. All other delays not the Contractor's or Department's fault or responsibility and not reasonably foreseeable or avoidable by the Contractor.

**C. Excusable, Compensable Delay.**

Excusable, compensable delays are delays that are not the Contractor's fault or responsibility but are the Department's fault or responsibility. For the following excusable, compensable delays, the Engineer will extend the Contract Time if the conditions specified in 108.07.A are met:

1. Delays due to revised Work as specified in 104.02.B or 104.02.C.
2. Delays due to an Engineer-ordered suspension as specified in 104.02.D.
3. Delays due to acts of the government or a political subdivision other than the Department; however, these compensable delay costs are limited to escalated labor and material costs only, as allowed in 109.04.
4. Delays due to the neglect of the Department or its failure to act in a timely manner.

Compensation for excusable, compensable delays will be determined by the Engineer according to 109.04.

**D. Non-Excusable Delays.**

Non-excusable delays are delays that are the Contractor's fault or responsibility or delays that the Contractor could have reasonably anticipated. Delays due to the Contractor's, Subcontractor's, or supplier's insolvency or mismanagement are not excusable. The Contractor is not entitled to a time extension or compensation for a non-excusable delay.

**E. Concurrent Delays.**

Concurrent delays are separate delays to critical activities occurring at the same time. When a non-excusable delay is concurrent with an excusable delay, the Contractor is not entitled to a time extension for the period the non-excusable delay is concurrent with the excusable delay. When a non-compensable delay is concurrent with a compensable delay, the Contractor is entitled to a time extension but not entitled to compensation for the period the non-compensable delay is concurrent with the compensable delay.

**F. Notification of Delay.**

In addition to the notice requirements of 104.02.G, the Contractor shall provide the following detailed information when giving notice of a delay:

- a) A detailed description of the events causing delay.
- b) The identification of the party(ies) responsible for the delay and the Contractual basis for this determination.
- c) Activities in the current Progress schedule affected by the delay.
- d) The magnitude of the delay, whether known or forecast, using the current Progress Schedule update as a basis for this determination.

**G. Record Keeping.**

After notifying the Contract Administrator of the delay, Contractor shall keep daily records of the labor, material, and equipment affected by the delay as specified in 109.04. The Contractor shall maintain a daily record of each operation affected by the delay and the station location(s) of the operations affected. Daily records of the operations and stations will also be maintained by the Department. Each Monday, the Contractor shall compare the previous week's daily records with the records kept by the Department. The Contractor shall also prepare and submit written reports to the Contract Administrator containing the following information each Monday:

1. Number of days behind schedule.
2. A summary of all operations that have been delayed, or will be delayed.
3. In the case of a compensable delay, the Contractor shall explain how the Department's act or omission delayed each operation, and estimate the amount of time required to complete the Project.
4. Itemize all extra costs being incurred, including:
  - a. How the extra costs relate to the delay and how they are being calculated and measured;
  - b. The identification of all non-salaried Project employees for whom costs are being compiled; and
  - c. A summary of time charges for equipment, identified by manufacturer's number for which costs are being compiled.

Provide written notice to the Engineer within ten days of the results of the comparison of the detailed reports performed each Monday and define any disagreements between specific records.

Failure to meet to review the Department's records or to report disagreements between the records shall establish that that the Department's records are accurate and that the Contractor agrees that the Department's records will be the basis for determining the delay and any compensation that may be due as a result of the delay. The Contractor waives entitlement to a time extension or compensation for delay incurred prior to notifying the Contract Administrator that operations have been delayed. Delay costs allegedly incurred prior to notifying the Contract Administrator that operations have been delayed will not be allowed.

## SECTION 108

### 108.08 Blank.

### 108.09 Failure to Complete on Time.

For each calendar day or work day that work remains uncompleted after the Contract Time, the sum specified below will be deducted from any money due the Contractor. This sum shall not be considered and treated as a penalty but as liquidated damages due the Department by reason of inconvenience to the public, added cost of Engineering and supervision, and other extra expenditures of public funds due to the Contractor's failure to complete the Work on time. Any adjustment of the Contract Time for completion of the Work granted under the provisions of 108.07 will be considered in the assessment of liquidated damages.

In the case of a date in the Contract being given for the completion of parts, phases, or stages, the liquidated damages will be deducted for the period during which that particular work remains incomplete.

Permission for the Contractor or Surety to continue and finish work after the Contract Time and approved time extensions have elapsed shall not waive the Department's rights under the Contract.

The assessment of all or any of the liquidated damages that accrue may be terminated if the Department has determined that the Work is substantially complete and is in a condition for safe and convenient use by the traveling public.

The Work will be considered substantially complete when all necessary signing, striping, guardrail, and other safety appurtenances have been installed, and when applicable opened to the traveling public. For projects that will not be opened to the traveling public, the Contract will be considered substantially complete when it is ready for the subsequent project. This shall not be construed as a Contractual right and its application will be contingent upon the Contractor's diligence in completing the remaining items of work.

Liquidated damages shall be assessed in accordance with the following schedule:

Original Contract Amount		Daily Charge	
From more than	To and including	Calendar Day	Working Day
\$0	\$100,000	\$260	\$370
100,000	750,000	520	740
750,000	2,000,000	780	1,110
2,000,000	5,000,000	1,040	1,480
5,000,000	10,000,000	1,550	2,210
10,000,000	20,000,000	2,070	2,950
20,000,000	----	2,580	3,690

When the Contract Time is on a calendar date basis, the schedule for calendar date shall be used. When the Contract time is on a working day basis, the schedule for working days shall be used.

When Acceptance has been made by the Engineer as prescribed in 105.17, the daily charge will no longer be assessed.

Should the amount of money otherwise due the Contractor be less than the amount of such liquidated damages, the Contractor and the Surety shall be liable to the State for such deficiency.

The Engineer has the right to deduct the amount of anticipated liquidated damages against the Contractor from any estimated payment for Work performed under the Contract; or to claim and recover such sums by process of law. Review of anticipated Contract completion and potential liquidated damages will commence when 80% of the original Contract Time has elapsed.

### 108.10 Default of Contract.

The Engineer may declare the Contract in default to the Contractor and the Surety advising them of the actions required for remedy if the Contractor:

- A. Fails to begin the Work under the Contract within the time specified in the Notice to Proceed, or
- B. Fails to perform the Work with sufficient resources to ensure the timely completion of the work, or
- C. Fails to perform the Work in accordance with the Contract requirements or neglects or refuses to remove and replace rejected materials or unacceptable work, or
- D. Discontinues the prosecution of the Work, or
- E. Fails to resume work which has been discontinued within a reasonable time after notice to do so, or
- F. Becomes insolvent, is declared bankrupt, or commits any act of bankruptcy. or insolvency, allows any final judgment to remain unsatisfied for a period of ten days, makes an assignment for the benefit of creditors, or
- G. Fails to comply with Contract requirements regarding minimum wage payments or EEO requirements, or
- H. Is a party to fraud.

The Engineer will give notice in writing to the Contractor and the Surety of such delay, neglect, or default.



If the Contractor or Surety does not proceed in accordance with the notice within ten days of receipt, the Department has full power and authority, without violating the Contract, to take the prosecution of the Work from the Contractor. The Department may appropriate or use Materials at the Project site and enter into an agreement with another Contractor for the completion of the Work remaining. Acceptable materials obtained by the Contractor for use on the Project and not yet included in the Work, may be purchased by the Department from the Contractor at invoiced costs.

The methods used for completion of the Contract will be determined by the Department.

All costs and charges incurred by the Department, as a result of the delay, neglect, or default, including the cost of completing the Work under Contract, and any applicable liquidated damages or disincentives will be deducted from money due the Contractor for completed work. If such costs exceed the sum that would have been payable under the Contract, the Contractor and Surety shall be liable and shall pay the Department the balance of such costs in excess of the Contract Amount.

If it is determined, after termination of the Contractor's right to proceed, that the Contractor was not in default, the rights and obligations of the parties will be the same as if the termination had been issued for the convenience of the Department under 108.11. Thus, damages to which a Contractor may be entitled as a result of the improper default termination will be limited to appropriate amounts for the items listed in 108.11.

#### **108.11 Termination of Contract for the Convenience of the Department.**

The Department may, with the concurrence of the Governor and Executive Council, and with the approval of the FHWA where applicable, terminate the entire Contract or any portion thereof, if the Engineer determines that a termination is in the Department's interest. The Engineer will deliver to the Contractor a Notice of Termination specifying the extent of termination and the effective date.

- A. **Submittals and Procedures.** After receipt of a Notice of Termination, the Contractor shall immediately proceed with the following obligations:
1. Stop Work as specified in the notice.
  2. Place no further subcontracts or orders or materials, services, or facilities, except as necessary to complete the continued portion of the Contract.
  3. Terminate all subcontracts to the extent they relate to the Work terminated.
  4. Settle all outstanding liabilities and termination settlement Proposals arising from the termination of purpose of this clause.
  5. Transfer title and deliver to the Department (1) the fabricated, partially fabricated, or unfabricated parts, Work in process, completed Work, supplies, and other material produced or acquired for the Work terminated, and (2) the completed or partially completed plans, drawings, information, and other property that, if the Contract had been completed, would be required to be furnished to the Department.
  6. Complete performance of the Work not terminated.
  7. Inventory acceptable Materials obtained by the Contractor for the Project that have not been incorporated in the Work in conjunction with the Engineer at a date identified by the Engineer.
  8. Take any action necessary, or that the Engineer may direct, for the protection and preservation of the property related to the Contract that is in the possession of the Contractor and in which the Department has or may acquire an interest.
- B. **Settlement Provisions.** When the Department orders termination of all or a part of the Contract effective on a certain date, completed items of Work as of the date will be paid for at the item bid price(s). Payment for partially completed Work will be made either at agreed prices or under the provisions below. Items that are eliminated in their entirety by such termination shall be paid for as provided in [104.02.F](#).
1. **Additional Costs.** Within 60 days of the effective termination date, the Contractor shall submit a claim for additional damages or costs not covered above or elsewhere in the Contract. Such claim may include such cost items as reasonable idle equipment time, mobilization efforts, bidding and project investigative costs, overhead expenses attributable to the Project terminated, accounting charges involved in claim preparation, Subcontractor costs not otherwise paid for, actual idle labor cost if Work is stopped in advance of termination date, guaranteed payments for private land usage as part of the original Contract, and any other cost or damage for which the Contractor feels reimbursement should be made. Anticipated profits will not be considered as part of any settlement.
- The Contractor and the Department may agree upon the whole or any part of the amount to be paid because of the termination. The settlement amount shall not exceed the total Contract Amount reduced by the amount of payments previously made plus payment for Work not terminated. The Contract shall be amended, and the Contractor paid the agreed amount.

## SECTION 108

2. Additional Cost Review. If the Contractor and the Department fail to agree on the whole amount to be paid the Contractor because of the termination of work, the Department will pay the amounts determined as follows, but without duplication of any amounts agreed upon above:
  - a. For Contract Work performed before the effective date of termination, the total (without duplication of any items) of:
    1. The Engineer will determine compensation in accordance with 109.04 for Work performed;
    2. The cost of settling and paying termination settlement Proposals under terminated subcontracts that are properly chargeable to the termination portion of the Contract if not included in subparagraph 1 above; and
    3. A sum, as profit on (1) above determined by the Department to be fair and reasonable. The Department shall allow no profit under this subdivision if the Contractor's costs incurred on work performed exceed the bid item payments made.
  - b. The reasonable costs of settlement of the work terminated, including:
    1. Accounting, clerical, and other expenses reasonably necessary for the preparation of termination settlement proposals and support data;
    2. The termination and settlement of subcontracts (excluding the amounts of such settlements); and
    3. Storage, transportation, and other costs incurred, reasonably necessary for the preservation, protection, or disposition of the termination inventory.
  - c. Except for normal spoilage, and to the extent that the Department expressly accepts the risk of loss, the Department will exclude from the fair value all that is destroyed, lost, stolen, or damaged so as to become undeliverable to the Department or to the buyer.
  - d. In arriving at the amount due the Contractor under this clause, there will be deducted -
    1. All unliquidated advance or other payments to the Contractor under the terminated portion of the Contract;
    2. Any claim that the Department has against the Contractor under the Contract; and
    3. The agreed price for, or proceeds from the sale of Materials, supplies, or other things acquired and sold by the Contractor not recovered by or credited to the Department.

If the termination is partial, the Contractor may file a proposal with the Department for an adjustment of the price(s) of the continued portion of the Contract. The Department will make any payment agreed upon. Any proposal for compensation under this clause shall be requested within 90 days from the effective date of termination unless extended in writing by the Engineer.

The Department may, under the terms and conditions it prescribes, make partial payments and payments against costs incurred by the Contractor for the terminated portion of the Contract, if these payments will not exceed the amount to which the Contractor is entitled.

The Contractor shall maintain and make available all project cost records to the Department for audit to the extent necessary to determine the validity and amount of each item claimed. This includes all books and other evidence bearing on the Contractor's costs and expenses under the Contract. These records and documents shall be made available to the Department at the Contractor's office, at all reasonable times, without charge. If approved by the Department, photographs, microphotographs, or other authentic reproductions may be maintained instead of original records and documents.

Termination of the Contract or portion thereof shall not relieve the Contractor of Contractual responsibilities for the Work completed, nor shall it relieve the Surety of its obligation for and concerning any just claims arising out of the Work performed.

### **108.12 Termination of Contractor's Responsibility.**

Whenever the improvement provided for by the Contract shall have been completely performed on the part of the Contractor and all parts of the Work have been approved and accepted, the Contractor shall then be released from further obligations except as set forth in their bond and as provided in 107.14.

### **108.13 Understanding of Parties Regarding Department's Performance.**

It is understood and agreed by the parties to the Contract that all obligations of the Department hereunder, including the continuance of payments, are contingent upon the appropriation and continued availability of State and Federal funds, and in no event shall the Department be liable for any payments hereunder in excess of such appropriated and available funds. In the event the General Court or any of its Committees orders the reduction of expenditures of State funds and the Governor and Council fails to encumber funds or reduces or terminates the expenditure of anticipated funds or appropriations relative to the Contract, the Department may, by written notice to the Contractor, immediately terminate the Contract in whole or in part in accordance with the applicable provisions of 108.11.

**SECTION 109 -- MEASUREMENT AND PAYMENT****109.01 Measurement of Quantities.**

Work completed under the Contract will be measured by the Engineer according to the United States customary measure or metric system, as specified for the Contract. The units of the two systems are not equal and therefore not interchangeable within a Contract.

A station, when used as a definition or term of measurement, will be 100 linear feet measured horizontally.

The method of measurement and computations to be used in determination of quantities of material furnished and work performed will be those methods generally recognized as conforming to good Engineering practice.

Unless otherwise specified, longitudinal measurements for area computations will be made horizontally, and no deductions will be made for individual objects having an area of 9 square feet or less. Unless otherwise specified, transverse measurements for area computations will be the neat dimensions shown on the plans or ordered in writing.

Structures will be measured according to neat lines shown on the plans or as ordered to fit field conditions.

Items which are measured by the linear foot, such as pipe culverts, guardrail, curb, underdrains, etc., will be measured parallel to the base or foundation upon which such structures are placed.

In computing volumes of excavation, embankment, and borrow, the average end area method will be used. Where it is impracticable to measure material by the cross-section method due to irregular, isolated deposits, acceptable methods involving three-dimensional measurement may be used. When measurement of materials in vehicles is permitted, the quantity will be determined as 80 percent of the loose volume.

In computing volumes of concrete and masonry, the prismatic method will be used.

The space occupied by pipe will not be included in the volume of headwalls. In the case of pipe having a wall thickness of 2" or more, the area of the pipe will be based on the manufacturer's nominal dimensions, outside to outside, or the shell of the pipe. In the case of pipe having a wall thickness of less than 2", the area of the pipe will be based on the nominal inside diameter of the pipe.

The thickness of plates and galvanized sheets used in the manufacture of corrugated metal pipe, metal plate pipe culverts and arches, and metal cribbing will be specified and measured in decimal fractions of inches.

The term "ton" will mean the short ton consisting of 2,000 pounds avoirdupois. Except as specified below, materials which are measured or proportioned by weight shall be weighed on scales that the Contractor has had sealed by the New Hampshire Department of Agriculture or by a company approved by that Department. All weighing shall be performed in a manner prescribed under the Rules and Regulations of the Bureau of Weights and Measures of the New Hampshire Department of Agriculture. Weighing of materials on scales located outside New Hampshire will be permitted for materials produced or stored outside the State, when requested by the Contractor. Out-of-State weighing, in order to be approved, must be performed on scales sealed by the appropriate governmental authority.

If material is shipped by rail, the car weight may be accepted, provided that payment is made only for the actual weight of material. Car weights will not be acceptable for material to be passed through mixing plants.

Trucks used to haul material being paid for by weight shall be weighed empty daily at times directed by the Engineer. Each truck shall bear a plainly legible identification mark.

When material is weighed, the individual weight slips, which shall be furnished by the Contractor, for trucks, trailers, or distributors, shall show the following information: the date, the project name and number; slip number; the material or commodity; the dealer or vendor; the Contractor or Subcontractor; the location of the scales; the time of loading; the vehicle registration number or other approved legible identification mark; the tare and net weights, with gross weights when applicable; and the weigher's name, signature, or signed initials.

The right is reserved to weigh any truck, trailer, or distributor, at locations designated, before and after making deliveries to the Project.

When requested by the Contractor and approved or ordered by the Engineer in writing, material specified to be measured by the cubic yard may be weighed and converted to cubic yards. Factors for conversion from weight measurement to volume measurement will be determined by the Engineer and agreed to by the Contractor before this method of measurement of pay quantities is used.

Bituminous materials will be measured by the gallon or short 2000 lb. Volumes will be converted to weights, or weights will be converted to gallons, corrected to volume at 60 °F, using ASTM D 1250 for asphalts or ASTM D 633 for tars.

To assist in computing the number of short ton, 2000 lb. of material required when the rate of application is specified in gallons per square yard, the following approximations may be used:

## SECTION 109

<b>Bitumen</b>	<b>Gallons per Ton at 60 °F</b>	<b>Pounds per Gallon at 60 °F</b>
RC-MC 70	248	8.05
RC-MC 250	247	8.11
RC-MC 800	244	8.18
RC-MC 3000	240	8.33
AC-10	235	8.51
AC-20	233	8.58
Emulsion	239	8.38

Each vehicle used in transporting liquid bituminous material shall be weighed before and after loading and the difference in weights used as the basis for computing pay quantities. A copy of the original weight slip shall be delivered with each truck shipment. In addition to the information required above, the following shall be shown on the slip: the plant and tank number from which the material was obtained, the grade of the material and the percent of additive, if any.

When a slip shows a “Part Load On” or indicates a “high tare,” the delivery slip shall be accompanied by a copy of the delivery or weight slip from the previous load indicating the grade of material together with substantiation of the tare weight of the vehicle. If the Engineer has already been furnished the slip with the previous load, reference by slip number will satisfy the latter part of this requirement.

Liquid bituminous material delivered but not used in the Work shall be weighed and credit given by the vendor. A copy of the weight slip showing such credit shall be returned to the Engineer within three days.

Timber will be measured by the thousand feet board measure (MBM) actually incorporated in the structure. Measurement will be based on nominal widths, thicknesses, and the extreme length of each piece.

The term “Unit,” , when used as an item of payment, will mean complete payment for the Work described in the Contract.

When a complete structure or structural unit (in effect, “Unit” work) is specified as the unit of measurement, the unit includes all necessary fittings and accessories.

Except as may be otherwise provided, partial payments for Unit items will be made approximately in proportion to the amount of the Work completed on those items.

Rental of equipment will be measured in hours of actual working time and necessary travel time of the equipment within the limits of the Project. If special equipment has been ordered by the Engineer in connection with force account work, travel time and transportation to the project will be measured. If equipment is ordered held on the property on a standby basis by the Engineer, payments will be made under [109.04.D.3](#).

When standard manufactured items are specified such as fence, wire, plates, rolled shapes, pipe, conduit, etc., and these items are identified by gauge, unit weight, section dimensions, etc., the identification will be considered to be nominal weights or dimensions. Unless more stringently controlled by tolerances in cited specifications, manufacturing tolerances established by the industries involved will be accepted.

Material wasted without authority will not be included in the final pay quantity.

When the estimated quantities for a specific portion of the Work are designated as final pay quantities in the Contract, they shall be the final pay quantities for which payment will be made in accordance with [109.11](#).

### **109.02 Scope of Payment.**

The Contractor shall receive and accept compensation provided for in the Contract as full payment for furnishing all materials; for performing work under the Contract in a complete and acceptable manner; and for all risk, loss, damage, or expense arising out of the nature or prosecution of the work, subject to the provisions of [107.14](#).

If the “Basis of Payment” clause relating to any unit price in the Contract requires that the unit price cover and be considered compensation for certain work or material essential to the item, this same work or material will not be measured or paid for under any other pay item appearing in the Contract.

The Contractor shall not use publicly-owned equipment on projects financed in whole or in part with federal funds except in exceptional cases where such rental may be clearly in the public interest. Public interest will be indicated to the Contractor in one of two ways:

- (1) when the Special Provisions suggest the possibility of renting specified equipment with the rates and points of availability or delivery of such equipment, or
- (2) if, during construction, an emergency should develop caused by breakdown or loss of equipment from accidents or other unforeseeable causes beyond the control of the Contractor, and the Contractor is otherwise unable to secure equipment with which to continue the work. In this emergency, publicly-owned equipment may be made available to the Contractor at rental rates agreeable between the Contractor and the Department or other public agency that owns the equipment.

**109.03 Compensation for Altered Quantities.**

When the accepted quantities of work vary from the quantities in the Contract, the Contractor shall accept payment at the original Contract unit prices for the accepted quantities of work performed except as provided for in 109.11. The Contractor is not entitled to compensation at unit prices different than those set forth in the Contract for quantities greater or less than estimated quantities, except as provided in Subsection 104.02 and then only if timely and sufficient notice has been provided in accordance with 104.02.G. A time extension for quantities in excess of the estimated quantities will be determined in accordance with 108.07.

**109.04 Payment for Revisions to the Contract.****109.04.1 General.**

If the Department revises the Contract as provided in 104.02, the Department will pay for the revision following the sequence specified in 109.04.2 through 109.04.4. Such payment will include compensation for performing the revised work, delay costs, and all other costs not expressly precluded by 109.04.5. The Department may, at any time, direct the Contractor to perform all or part of the revised work in accordance with 109.04.4. Force Account.

If a Contract Revision includes a time extension for compensable delays as provided by 108.07, the Department will pay the costs associated with time extension in accordance with 109.04.6.

**109.04.2 Contract Pay Item.**

Before proceeding to another pricing method, the Engineer will attempt to price and pay for revised work using Item Bid Price.

**109.04.3 Negotiated Prices.**

If the Engineer and Contractor cannot agree on compensation in accordance with 109.04.2 they will attempt to negotiate the price of a Contract Revision.

When determining a negotiated price, the Contractor shall first provide an estimate of the proposed unit prices or lump sum price for the Contract Revision to the Engineer. The Engineer may request that the Contractor justify the estimate by providing one or more of the following:

1. Labor requirements by trade in hours for each task.
2. Equipment costs and time requirements.
3. Material costs.

The Contractor shall provide the justification within 5 working days after the Department's request. The Department will respond to the estimate within 5 working days after receipt of the Contractor's justification. The Department and the Contractor can mutually agree to extend these 5-day requirements.

If the Department and the Contractor cannot agree on a negotiated price for the Contract Revision, the Engineer may direct the Contractor to perform all or part of the revised work in accordance with 109.04.4 Force Account.

**109.04.4 Force Account.****109.04.4.1 General.**

When directed to perform work on a force account basis the Department will pay the Contractor as specified in 109.04.4.2 through 109.04.4.6, as full compensation for performing the force account work, including delay costs, and all other associated costs. The Engineer may request the Contractor submit a written proposal for the work, including the planned equipment, materials, labor, and work schedule.

The Contractor's representative and the Engineer at the end of each work day shall compare records of the cost of work completed on a Force Account basis. These daily records shall be set forth on the forms provided by the Engineer and shall thereafter be considered to be the basis for payment of the work performed, but shall not preclude subsequent revision based on a later audit by the Department.

No payments will be made for work performed on a Force Account basis until the Contractor has furnished the Engineer with a statement of the cost of the Force Account work showing the following:

- a. Name of Subcontractor, if appropriate.
- b. Name, classification, date, daily hours, total hours, rate, and extension for each laborer, operator, and foreman.
- c. Quantities of materials, prices, and extensions.
- d. Charges for transportation of materials.
- e. Specialized work charges.
- f. Designation, dates, daily hours, total hours, rental rate, and extension for each unit of equipment or plant.
- g. Cost of property damage liability, and worker's compensation insurance premiums, unemployment insurance contributions, and social security.

## SECTION 109

The Contractor shall certify that the labor, materials, and equipment listed were actually used on the Force Account Work described, that the labor and equipment were used for the hours indicated, and that the rates for labor do not exceed those for comparable labor currently employed on the project.

Statements shall be accompanied and supported by certified copies of the appropriate payrolls, and invoices for all materials and specialized work and for transportation charges. If materials used on the Force Account work are not specifically purchased for the work but are taken from the Contractor's stock, the Engineer shall be furnished an affidavit certifying that the materials were taken from stock, that the quantity claimed was actually used, and that the price and transportation costs claimed represent the Contractor's actual cost.

During the life of the Contract and for a period of not less than three years after the date of Acceptance thereof, the Contractor's cost records pertaining to work paid for on a Force Account basis shall be open to inspection or audit by representatives of the Department, and the Contractor shall retain such records for that period. Where payment for materials or labor is based on the cost thereof to forces other than the Contractor, the Contractor shall make every reasonable effort to ensure that the cost records of such other forces will be open to inspection and audit by representatives of the Department on the same terms and conditions as the cost records of the Contractor.

Payment for force account work will be determined by the Engineer as follows:

### **109.04.4.2 Labor.**

For all labor, including equipment operators, and foremen in direct charge of the specific operation, the Contractor shall receive the rate of wage agreed to in writing for each and every hour that the labor and foreman are actually engaged in the work. In case the Contractor is required to pay overtime pay or holiday pay to labor engaged in the Work, such rate will be the rate reimbursed. When the Contractor is ordered to return to the project solely to perform Force Account work, labor will be considered as being actually engaged in the Work during the hours while traveling.

No part of the salary or expenses of anyone connected with the Contractor's forces above the grade of foreman or having general supervision of the Work will be included in the labor item as specified above.

The Contractor will also receive an additional amount (i.e. a labor burden rate) equal to 50 percent of the actual hourly wage rate paid to, or in behalf of workers, for costs of health and welfare benefits, taxes, insurances, retirement, and union benefits. A Contractor can request a different labor burden rate be used if an independently audited breakdown of the actual aforementioned costs, prepared by a Certified Public Accountant, is provided. The audit of the burden rate shall be prepared on current financial data and in conformity with the accounting practices prescribed by the Federal Acquisition Regulations 48 CFR, Part 31.

An amount equal to ten percent of the sum of the above items will also be paid the Contractor to compensate for all field and home office overhead costs and profit.

Subsistence and travel expenses paid by the Contractor will be reimbursed only when the Engineer orders Force Account Work and, in order to perform such work, it is necessary to move workers to the project particularly for that operation. Such subsistence and travel expenses allowed shall be carried on the daily report form under the classification of "Material," without, however, being subject to the added percentage for materials. If work other than such Force Account Work is performed by the individuals during or in connection with that operation, no subsistence or travel expenses will be allowed.

### **109.04.4.3. Materials and Specialized Work.**

**109.04.4.3.1. Materials.** The actual cost of materials per itemized invoice approved for use by the Engineer and incorporated into the work, including transportation charges (exclusive of equipment rentals as hereinafter set forth) will be paid to the Contractor, to which cost 15 percent will be added to compensate for field and home office overhead costs and profit.

The cost of materials will be the cost to the purchaser, whether Contractor, Subcontractor, or other, from the supplier thereof, except as the following are applicable:

- a. If materials are procured by the purchaser by any method which is not a direct purchase from and a direct billing by the actual supplier to such purchaser, the cost of such materials will be deemed to be the price paid to the actual supplier as determined by the Engineer. No markup except for actual costs incurred in the handling of such materials will be permitted.
- b. If the materials are obtained from a supply or source owned wholly or in part by the purchaser, payment will not exceed the price paid by the purchaser for similar materials furnished from said source on Contract items or the current wholesale price for such materials delivered to the job site, whichever price is lower.
- c. If, in the opinion of the Engineer, the cost of such materials is excessive, then the cost of such material will be deemed to be the lowest current wholesale price at which such materials are available in the quantities concerned delivered to the job site.
- d. If the Contractor does not furnish satisfactory evidence of the cost of such materials from the actual supplier, the cost will then be determined in accordance with paragraph (c).

**109.04.4.3.2 Specialized Work.** Work directed by the Engineer not included in the Contract and not performed by the Contractor or Subcontractor, requiring special skills, tools, and equipment unlike those used by the Contractor. Payment for such specialized work shall be based on current market prices and industry practice per an itemized invoice. If accepted, the Contractor will receive the cost of the invoice to which cost 5 percent will be added to compensate for field and home office overhead costs and profit.

In those instances wherein a Contractor is required to perform Extra Work necessitating a fabrication or machining process in a fabrication or machine shop facility away from the job site, the charges for that portion of such work performed in such facility may, by agreement, be accepted as Specialized Work.

**109.04.4.4 Equipment and Plant.**

For any Contractor-owned machinery or special equipment (other than small tools), the use of which is approved by the Engineer, the hourly rate will not exceed that determined from the appropriate edition of the “ Rental Rate Blue Book for Construction Equipment” published by Equipment Watch used in the following manner:

- a. The hourly equipment rental rate R will be determined by formula as follows:

$$R = (A \times B \times C) + D$$

Where A = Monthly rate divided by 176. The listed weekly, hourly, and daily rates will not be used.

B = Average regional adjustment factor for New Hampshire.

C = Factor from Rate Adjustment Table for the year of equipment manufacture.

D = Estimated operating costs per hour.

- b. The number of hours to be paid for will be the number of hours that the equipment or plant is actually used on a specific Force Account activity and, in addition, shall include the time required to move the equipment to the location of such Force Account activity and return it to the original location or to another location requiring no more time than that required to return it to its original location, except that moving time will not be paid for if the equipment is used during the move on work other than the specific Force Account activity.
- c. The current revision of the “ Blue Book” applicable to the specific Force Account work is as of the beginning of the calendar year in which the Extra Work is being performed. Revised sections published during the year will not be incorporated in the “ Blue Book” until the beginning of the next calendar year.
- d. The average regional adjustment factor applicable for this Contract will be specified in the Supplemental Specification for this Subsection. The average regional adjustment factor will be reviewed and revised annually subsequent to revisions of “ Blue Book” sections. Equipment life adjustments will be made using the rate adjustment tables.
- e. Overtime shall be charged at the same rate indicated in subparagraph (a) above.
- f. The estimated operating costs per hour will be used for each hour that the equipment or plant is in operation on the Force Account work. Operating costs are not reimbursable for the time the equipment is idle.
- g. The maximum rental period to be paid for per day shall not exceed eight hours unless the equipment operates for eight or more hours.
- h. If equipment is idled solely due to the responsibility of the Department, then the Contractor may be compensated for such idle equipment at 50% of the rate defined in “ A” above (monthly rate divided by 176).
- i. The rates established above shall include the cost of fuel, oil, lubrication, supplies, small tools, necessary attachments, repairs, overhauls, and maintenance of any kind, depreciation, storage, field and home office overhead, profits, insurance, and all incidentals.

The Contractor shall provide the Engineer with the following: the manufacturer’s name, equipment type, year of manufacture, model number, type of fuel used, horsepower rating, attachments required, together with their size or capacity, and any further information necessary to ascertain the proper rate. Unless otherwise specified, manufacturer’s ratings and manufacturer approved modifications shall be used to classify equipment for the determination of applicable rental rates. Equipment which has no direct power unit shall be powered by a unit of at least the minimum rating recommended by the manufacturer. The Contractor shall have available for the Engineer’s use a revised copy of the “ Blue Book” as referenced above.

Equipment used by the Contractor shall be in good working condition and shall be of suitable size and suitable capacity required for the work to be performed. The rate for the basic equipment with the appropriate attachments shall include only the rate for the combined equipment necessary to perform the Extra Work. In case the Contractor elects to use equipment of a higher rental value than that suitable for the work, payment will be made at the rate applicable to the suitable equipment. The equipment actually used and the suitable equipment to be paid for will be recorded as a part of the record for Force Account work. The Engineer will determine the suitability of the equipment. If there is a differential in the rate of pay of the operator of oversize or higher rate equipment, the rate paid for the operator will likewise be that for the suitable equipment.

## SECTION 109

Payable time periods will not include:

- (1) time elapsed while equipment is inoperative due to breakdowns,
- (2) time spent repairing equipment, or
- (3) time elapsed 24 hours after the Engineer has advised the Contractor that the equipment is no longer needed.

If a piece of equipment is needed that is not listed in the above stated rental rate guide, a rate will be established by the Engineer in writing before the equipment is used. The Contractor may furnish any cost data which might assist the Engineer in the establishment of such rate.

If the Contractor does not own a specific type of equipment or if the Department orders the Contractor to utilize a specific type of equipment and the equipment must be obtained by rental, the Contractor shall inform the Contract Administrator of the need to rent the equipment and of the rental rate for that equipment before using it on the work. Provided that the rate is reasonable, the Contractor will be paid the actual rental cost for the equipment for the time that the equipment is actually used to accomplish the work, plus the cost of moving the equipment onto and away from the job. A 5 percent mark-up will be added to the actual rental cost, provided the total cost does not exceed the *Rental Rate Blue Book for Construction Equipment* rate (in accordance with 109.04.4.4(a)). The Contractor shall provide a copy of the paid receipt or canceled check for the rental expense incurred.

Transportation charges for each piece of equipment, whether owned or rented, moved to and from the site of the work will be paid provided:

- (1) the equipment is obtained from the nearest approved source,
- (2) the return charges do not exceed the delivery charges,
- (3) haul rates do not exceed the established rates of licensed haulers,
- (4) charges are restricted to those units or equipment not already available and not on or near the Project, and
- (5) equipment is not used elsewhere on the project.

### **109.04.4.5 Miscellaneous.**

No additional allowance will be made for general superintendence, the use of small tools, or for other costs for which no specific allowance is provided.

### **109.04.4.6 Subcontracting.**

For administration costs in connection with approved subcontract work, the Contractor shall receive an amount equal to five percent of the total cost of work computed as set forth above to compensate for field and home office overhead costs and profit, except that no percentage will be allowed for equipment rented from the Contractor.

### **109.04.4.7 Bond.**

The Contractor will receive the actual costs for bond premium as a percentage of the total cost of the Work computed as set forth above for work paid under items not originally in the Contract. The Contractor shall furnish evidence of the rate paid for such bond.

### **109.04.4.8 Compensation.**

The compensation herein provided shall be accepted by the Contractor as payment in full for Force Account work, including superintendence, subcontracting, taxes, bond, field and home office overhead, profit, and other costs in connection with the Work which are not provided for.

### **109.04.5 Non-Allowable Charges.**

Whether payments for Contract Revisions are based on negotiated unit prices, agreed lump sum prices, negotiated prices, or force account, the Department will not reimburse the Contractor for the following:

1. Home office overhead or profit in excess of that specified in 109.04.2 through 109.04.5.
2. Loss of anticipated profit.
3. Consequential damages, including loss of bonding capacity, loss of bidding opportunities, and insolvency.
4. Indirect costs.
5. Attorneys' fees, claims preparation expenses, or costs of litigation.
6. Interest.

### **109.04.6 Compensation for Delay**

**109.04.6.1 General.** For a compensable delay as identified in 108.07.D, the Department will pay for the costs specified in 109.04.6.2. The Department will not pay for non-allowable charges specified in 109.04.5, nor duplicate payment made under 109.04.2 through 109.04.4.



The Department will make no payment for delay costs before the Contractor submits an itemized statement of those costs. Provide the following content for the applicable items in this statement.

#### **109.04.6.2 Allowable Delay Costs.**

**109.04.6.2.1 Extended Field Office Overhead.** The Department will pay the Contractor for extended field office overhead costs that include costs for general field supervision, field office facilities and supplies, and for maintenance of field operations.

General field supervision labor costs include, but are not limited to, field supervisors, assistants, watchman, clerical, and other field support staff. Compute these labor costs as specified in 109.04.4.2. For salaried personnel, calculate the daily wage rate actually paid by dividing the weekly salary by 5 days per week.

Field office facility and supply costs include, but are not limited to, field office trailers, tool trailers, office equipment rental, temporary toilets, and other incidental facilities and supplies. Compute these costs to provide these services on a calendar-day basis using actual costs incurred due to the delay.

Maintenance of field operations costs include, but are not limited to, telephone, electric, water, and other similar expenses. Compute these costs to maintain these services on a calendar-day basis using actual costs incurred due to the delay.

**109.04.6.2.2 Idle Labor.** Compute labor costs during delays as specified in 109.04.4.2 for all non-salaried personnel remaining on the project as required under collective bargaining agreements or for other Engineer-approved reasons.

**109.04.6.2.3 Escalated Labor.** To receive payment for escalated labor, demonstrate that the Department-caused delay forced the work to be performed during a period when labor costs were higher than planned at the time of bid. Provide adequate support documentation for labor costs, allowances, and benefits.

**109.04.6.2.4 Idle Equipment or Equipment Demobilization.** The Department will pay the Contractor the idle equipment rate calculated in 109.04.4.4 for equipment, other than small tools, that must remain on the project during Department-caused delays. The Department will pay the Contractor's transportation costs to remove and return equipment not required on the project during delays.

**109.04.6.2.5 Materials Escalation or Material Storage.** The Department will pay the Contractor for increased material costs or material storage costs due to the Department-caused delay. Obtain the Engineer's approval before storing material due to a delay.

#### **109.05 Blank.**

#### **109.06 Progress Payments.**

Progress payments will be made at least once each month as the work progresses. Progress payments may be prepared twice each month by the Engineer. Payments will be based on estimates prepared by the Engineer for the value of the work performed and materials placed under the Contract and for materials in accordance with 109.07 or 109.08.

No progress payment will be made when the total value of the work done since the last estimate amounts to less than \$1,000.00.

No money, payable under the Contract or any part, except the estimate for the first month or period, shall become due and payable, if the Engineer so elects, until the Contractor satisfies the Engineer that the Contractor has fully settled or paid for all labor performed or furnished, for all equipment hired, including trucks, for all materials used, and for fuels, lubricants, power, tools, hardware, and supplies purchased by the Contractor and used in carrying out said Contract and for labor and parts furnished upon the order of said Contractor for the repair of equipment used in carrying out said Contract. The Engineer may pay any and all such bills, in whole or in part, and deduct the amount so paid from any monthly or final estimate, excepting the first estimate.

#### **109.07 Payment for Material on Hand.**

Partial payments may be made for materials to be incorporated in the work, provided the materials meet the requirements of the Contract and are delivered on, or in the vicinity of, the Project site and stored in acceptable places. Partial payments will not exceed 90 percent of the Contract unit price for the item or the amount supported by copies of paid invoices, freight bills, or other supporting documents required by the Engineer. The quantity paid will not exceed the corresponding quantity estimated in the Contract.

No partial payment will be made on living or perishable materials until incorporated in the work.

When material payments exceed \$100,000.00 or 10 percent of the total Contract amount, whichever is less, notarized copies of paid invoices or copies of canceled checks for all such materials must be submitted to the Engineer within 45 days of the end date of the estimate on which the material allowance was paid. Failure to provide such documentation will result in the deduction of such material allowance from future estimates until documentation is provided.

#### **109.08 Payment for Material Not on Hand.**

Upon receipt of a written request by the Contractor, partial payment may be made for acceptable, fully-fabricated, nonperishable materials not delivered that are unique to the Project provided the materials meet the requirements of the Contract

## SECTION 109

and are stored in excess of 30 days at locations approved by the Engineer, preferably within the State of New Hampshire, and provided all required certificates of compliance, mill test reports, shop inspector's acceptance, and any other required materials certification have been furnished. Though not fully fabricated, an exception may be allowed for payment for structural steel plate, beams, bearing piles, and reinforcing provided per Items 550.1x, 510.61x, and 544; partial payment for these items may be made as stipulated below. Materials shall be identifiable and accessible for inspection. Storage areas shall provide adequate protection so that such materials will meet the Contract requirements upon delivery to the site.

Partial payment will be based on the material invoices the Contractor shall furnish to the Engineer. Notarized copies of paid invoices or copies of canceled checks for all such materials must be submitted to the Engineer within 45 days of the end date of the estimate on which the material allowance was paid. Failure to provide such documentation will result in the deduction of such material allowance from future estimates until documentation is provided.

Payment shall not exceed 90 percent of the bid price. No payment will be made on materials for any item in the Contract whose total dollar value is less than \$5,000. Approval of partial payment will not constitute acceptance of the materials for use in completing items of work.

### 109.09 Prompt Payments to Subcontractors.

The Prime Contractor shall pay all Subcontractors for the work performed no later than 21 calendar days from the date the Prime Contractor received payment from the Department for said work, including materials in accordance with 109.07 and/or 109.08 paid for in the progress payments. Subcontractors are required to pay their Subcontractors and/or material suppliers, within 21 calendar days from the date they receive payment for satisfactory work performed or supplies received. This Prompt Pay requirement shall be made part of all subcontracts and agreements.

If the Prime Contractor believes that any portion of the payment should be withheld from the Subcontractor, the Prime Contractor shall notify the NHDOT Contract Administrator in writing, prior to the estimate being processed. The NHDOT Office of Federal Compliance shall be made part of this notification. The NHDOT may withhold payment for the portion of work in dispute pending resolution.

This prompt payment provision is a requirement of 49 CFR 26.29 and does not confer third-party beneficiary right or other direct right to a Subcontractor against the Department. This provision applies to both DBE and non-DBE Subcontractors.

**Satisfactory Work Performed.** Satisfactory work performed shall be defined for purposes of this prompt payment provision as:

1. Upon review, the Engineer finds the work completed in accordance with the contract, plans and specifications, and;
2. Required paperwork, for Progress and Partial payments, including material certifications and payrolls, has been received.

The determination of whether work meets the standards set forth above is the responsibility of the Engineer. If the Subcontractor becomes insolvent after it satisfactorily performs work as defined above but before payment is due, the obligation to pay is not extinguished. (Payment may have to be made to the bankruptcy trustee or to an escrow account for the benefit of creditors.)

The Prime Contractor must include, in all subcontract agreements, notices to Subcontractors of their right to prompt payment, and of the Department's policy prohibiting Prime Contractor's from holding retainage from Subcontractors under 49 CFR 26.29.

Failure of a Prime Contractor or a Subcontractor to comply with these prompt payment provisions may result in sanctions.

- **Non-Payment Claims.** All notifications of failure to meet prompt payment provisions shall be referred by Subcontractors, in writing, to the NHDOT Office of Federal Compliance with a copy supplied to the respective Contract Administrator.
- **Payment Certifications.** The Prime Contractor or any Subcontractor who receives payment for work and/or materials (specifically supplied to the project in excess of \$10,000) shall submit a "Monthly Prompt Pay Certification," OFC Form 18, to the NHDOT Office of Federal Compliance no later than the 10<sup>th</sup> calendar day of each month.

### 109.10 Acceptance and Final Payment.

When the project has been accepted as provided in 105.17 and 107.14 and upon submission by the Contractor of all required reports, completed forms, and certifications, the Engineer will prepare the final estimate of the Work performed. The Contractor may be required to certify that all bills for labor and material used under this Contract have been paid.

If the Contractor accepts the final estimate or files no claims or objections to the quantities therein within 60 days of receiving the final estimate, the Department will process the estimate for final payment. Upon acceptance of the final estimate by the Contractor or after the 60 day waiver of claims, payment will be made for the entire sum found to be due after deducting all previous payments and all amounts to be retained or deducted under the provisions of the Contract.

If the Contractor files a claim under the Contract requirements, it shall be submitted in accordance with 105.18. Upon review or final adjudication of the claim, any additional payment determined to be due the Contractor will be placed on a supplemental estimate and processed for payment.

All prior partial estimates and payments shall be subject to correction in the final estimate and payment. If the final estimate shows an overpayment was made to the Contractor, then the Contractor shall pay this amount to the Department within 60 days of receipt of the final estimate, unless a valid claim has been filed in accordance with 105.18. If the Contractor fails to make the reimbursement as prescribed, the Department will send a Notice of Non-Payment letter giving the Contractor an additional 30-days to make payment. If payment is not received as prescribed the Department will, in writing, temporarily suspend the Contractor's bidding privileges for 60 days. If the Contractor fails to make the reimbursement within the suspension, the Department will, in writing, initiate steps to remove the Contractor from the Pre-Qualifications list and refer the matter to the Attorney General's Office for further action and Surety notification.

#### 109.11 Final Pay Quantity.

When an item of work is designated as a final pay quantity in the Method of Measurement, or Basis of Payment, or Bid Schedule as (F), the estimated bid quantity for that item of work shall be the final pay quantity, unless the dimensions of any portion or the quantity of that item are revised by the Engineer, or the item or any portion of the item is eliminated. If the dimensions of any portion or the quantity of the item are revised, and the revision results in an increase or decrease in the estimated quantity of that item of work, the final pay quantity for the item will be revised in the amount represented by the changes in the dimensions or the quantity. If a final pay item is eliminated, the estimated quantity for the item will be eliminated. If a portion of a final pay item is eliminated, the final pay quantity will be revised in the amount represented by the eliminated portion of the item of work.

The estimated quantity for each item of work designated as a final pay quantity in the Method of Measurement or Basis of Payment or Bid Schedule shall be considered as approximate only, and no guarantee is made that the quantity that can be determined by computations, based on the details and dimensions shown on the plans, will equal the estimated quantity. No adjustment will be made in the event that the actual quantity based on measurements / computations does not equal the estimated quantity except under the following conditions:

- a. **For Bridge Items:** If the actual value\* of the discrepancy is either \$10,000.00 more or \$10,000.00 less than the estimated bid amount for the item, or the actual quantity is more than 125 percent or less than 75 percent of the estimated bid quantity for that bridge item on that structure, then an adjustment will be made in accordance with 109.04.3.
- b. **For Other Items:** If the actual value\* of the discrepancy is either \$10,000.00 more or \$10,000.00 less than the estimated bid amount for the item, or the actual quantity is more than 125 percent or less than 75 percent of the estimated bid quantity, then an adjustment will be made in accordance with 109.04.3.

\* Actual value is determined by materials, equipment, and labor (not necessarily the bid price).

The Contractor may review the computations of final pay quantity items at the Department of Transportation in Concord. The computations requested will be available within one Working Day after a request is received by the contact person stated in the Invitation for Bids.

In case of discrepancy between the quantity shown in the Bid Schedule for a final pay item and the quantity or summation of quantities for the same item shown on the plans or in the proposal, payment will be based on the quantity shown in the Bid Schedule.



**DIVISION 200 -- EARTHWORK****SECTION 201 -- CLEARING AND GRUBBING****Description**

**1.1** This work shall consist of clearing and grubbing within the limits shown on the plans or as ordered, except objects designated to be removed in accordance with other sections of these Specifications. Vegetation and objects designated or ordered to remain shall be preserved from injury or damage.

**1.2** This work shall also consist of clearing and grubbing areas of brush within the project limits, but outside the limits of clearing and grubbing shown on the plans

**1.3** The items of removing trees, pruning trees, removing stumps, roadside clean up, and selective clearing and thinning will be used for work performed outside of the areas designated under 1.1 and 1.2.

**1.4 Definitions:**

- (a) Clearing. Cutting, removing and disposing of all trees, logs, brush, debris and vegetation within a designated area.
- (b) Grubbing. Removing and disposing of all stumps and roots within a designated area.
- (c) Large Tree. Tree measuring in circumference 75" and over at a point 4 ft. above the average ground.
- (d) Small Tree. Tree measuring in circumference less than 75" but more than 12" at a point 4 ft. above the average ground.
- (e) Brush. Area of growth including grass, weeds, crops and trees measuring in circumference 12" or less at a point 4 ft. above the average ground.

**Construction Requirements****3.1 Clearing and Grubbing.**

**3.1.1** No trees shall be cut until designated by the Engineer. Particular reference is made to fruit, ornamental or shade trees or plants at the edge of the roadside slopes. Cut or scarred surfaces of trees or shrubs selected for retention shall be painted with an approved wound dressing or treated according to other accepted arboricultural practices.

**3.1.1.1** The Contractor may be required to file an intent to cut and shall pay all charges, fees, and taxes as may be required under Chapter 79 of the RSA.

**3.1.2** All trees ordered to be cut shall become the property of and shall be disposed of by the Contractor, except as provided hereinafter. In the interest of energy and material conservation, the Contractor shall salvage wood from cut trees in accordance with standard commercial logging practices.

**3.1.3** Unless otherwise shown on the plans, clearing and grubbing shall extend 10 ft. beyond areas of excavation and 5 ft. beyond embankment slopes.

**3.1.4** The Contractor shall perform the work of clearing and grubbing to include the removal of only the materials specified herein. In order to conserve topsoil, rake teeth on bulldozers shall be used when removing stumps and brush unless other equipment is permitted.

**3.1.5** Except in areas designated to be excavated, any excavation caused by the grubbing operations shall be filled with suitable material and compacted to conform to the surrounding ground.

**3.1.6** All stumps and large roots within the limits of the roadbed shall be completely removed to a depth of 3 ft. below subgrade unless a greater or lesser depth is specified on the plans. Stumps within the limits of the roadbed below such depth and stumps under embankments or outside the roadbed shall be cut off within 6" of the existing ground surface except in the area to be rounded at the top of backslopes, where stumps are to be cut off flush with the surface of the final slope line or removed at the Contractor's option.

**3.1.6.1** When stumps are designated to be removed by grinding, the Contractor shall use an approved stump-grinding machine such that no damage occurs to surrounding structures.

**3.1.7** All stumps, roots, branches, brush, weeds, and other perishable material resulting from the clearing and grubbing operations shall be disposed of by an approved method. The Contractor's attention is directed to RSA 149-M regarding the fact that stumps and roots from grubbing operations are classified as solid waste. As such, these stumps shall be disposed of in permitted sites, through firms having facilities to convert the stumps to marketable products, or by grinding or chipping. Permits for sites are obtained from the New Hampshire Department of Environmental Services, Division of Waste Management. It is the responsibility of the person disposing of the stumps to obtain all the necessary permits and to comply with the New Hampshire Solid Waste Rules and Design Standards in effect at the time of disposal.

## SECTION 201

**3.1.7.1** All wood less than 5" in diameter and not cut into 4 ft. lengths for firewood shall be chipped. Burying of brush will not be permitted. Stumps, roots, and rotten wood may be buried at approved sites on or off the project. Approved sites shall have a minimum of 24" of cover material and shall be graded and shaped as directed by the Engineer. If burial is to be on private land, the agreements as to how the area is to be left shall be set forth on the Disposal Agreement form provided by the Department in accordance with 106.10. Three signed copies of the Disposal Agreement shall be furnished to the Engineer. Approval of the proposed disposal area will be contingent upon agreement by the Contractor and the property owner to leave the area in such shape that it blends with the surrounding terrain and that erosion is kept to a minimum. Without special permission, slopes shall not be left steeper than 3:1 (horizontal to vertical). No disposal area shall be left in such condition that erosion, after completion of the work, might result in water pollution by silt or other deleterious substances. Areas shall be left in such shape and condition that material does not wash and block or obstruct drainage ways. If holes caused by settlement appear, they shall be filled as directed. A release from the property owner is required prior to final project acceptance.

**3.1.7.2** Except in the case where wood is piled neatly for future use, storage locations should be outside the limits of view from the project, other highways, and residences.

**3.1.7.3** When ordered, available chipped material shall be stockpiled in the quantity directed to be used for erosion control. The Contractor may market any remaining chips or dispose of them by other approved methods.

**3.1.7.4** Unless otherwise ordered, disposal areas shall be covered with material capable of supporting vegetation and either fertilized and seeded with grass seed or planted with seedlings. Seedlings shall be set out in accordance with accepted horticultural practices as directed in the agreement.

**3.1.7.5** Unless permission is given to preserve access roads to disposal areas adjacent to highways, such access roads shall be obliterated.

**3.1.8** When fence lines go through wooded areas, a strip 3 ft. wide shall be cleared for the fence line.

### 3.2 Roadside Cleanup.

**3.2.1** Roadside cleanup of leaning, dead, unsound, and unsightly trees, branches, stubs, refuse, and slash (material remaining after logging operations), generally to a limit of approximately 15 ft. outside the limits specified in 3.1.3 above, shall be performed where and as directed. The material shall be disposed of as provided in 3.1. This work will not ordinarily be required outside of the right-of-way lines, but the Engineer may order that portions of medians or entire medians be cleaned up under this Section. All tree trimming in connection with roadside cleanup shall be done in accordance with accepted tree surgery practices.

### 3.3 Trimming of Trees.

**3.3.1** On trees or shrubs designated to remain, low hanging, unsound, or unsightly branches shall be removed as directed. Branches of trees extending over the roadbed shall be trimmed to give a clear height of 20 ft. above the roadbed surface. All trimming shall be done in accordance with accepted tree surgery practices.

### 3.4 Invasive Species.

**3.4.1** Statutory authority of RSA 430:55, the NH Department of Agriculture, Markets, and Foods prohibits the spread of invasive plants listed in Table 3800.1 of Part AGR 3800. Follow best management practices (BMPs) to avoid spreading these plants to new sites. The NHDOT manual "Best Management Practices for Roadside Invasive Plants" is available on line at the [Department's Website](#) or through the NHDOT Records Section (603) 271-1601.

### Method of Measurement

**4.1** Clearing, grubbing, and clearing and grubbing will not be measured, but shall be the acre final pay quantity in accordance with 109.11 for the area(s) shown on the plans.

**4.1.1** Clearing for fence lines will not be measured, but shall be the acre final pay quantity in accordance with 109.11 for the area(s) shown on the plans.

**4.2** Trees will be measured by the number of trees of each size removed or pruned.

**4.3** Stumps will be measured by the number of stumps removed measuring more than 12" in circumference at the cutoff. Stumps of trees cut by the Contractor will not be measured.

**4.4** Roadside cleanup will be measured by the acre, to the nearest 0.01 acre.

**4.5** Selective clearing and thinning will not be measured, but shall be the acre final pay quantity in accordance with 109.11 for the area(s) shown on the plans.

### Basis of Payment

**5.1** Clearing, grubbing, and clearing and grubbing are final pay quantity items and will be paid for at the Contract unit prices per acre in accordance with [109.11](#).

**5.1.1** When no quantity for clearing and grubbing is included in the Contract, the work will be subsidiary.

**5.1.2** Clearing for fence lines is a final pay quantity item and will be paid for at the Contract unit price per acre in accordance with [109.11](#).

**5.1.3** When no quantity for clearing for fence lines is included in the Contract, the work will be subsidiary.

**5.1.4** Clearing and grubbing in areas of brush within the project limits, but outside the limits shown on the plans will be subsidiary.

**5.2** The accepted quantities of removed trees and their stumps will be paid for at the Contract unit price per each of the size of tree specified.

**5.2.1** When an item for removing trees but no item for removing stumps appears in the Contract, each stump shown on the plans as a tree and removed as ordered will be paid for at one-half the Item Bid Price of a tree of the respective size shown.

**5.2.2** This item will not include trees and stumps removed from areas paid for under clearing and grubbing, roadside cleanup, or trees or stumps previously disposed of.

**5.2.3** When there is no item for removing small trees and there is an item for large trees, small trees shall be paid for at one-half the Item Bid Price of large trees; conversely large trees shall be paid for at two times the Item Bid Price for small trees.

**5.2.4** When no quantity for large trees and their stumps is included in the Contract, the removal of large trees and their stumps will be paid for as provided in [109.04](#).

**5.2.4.1** When no quantity for small trees and their stumps is included in the Contract, the removal of small trees and their stumps will be subsidiary.

**5.3** The accepted quantity of stumps will be paid for at the Contract unit price per each.

**5.3.1** When no quantity of stumps is included in the Contract, the removal of stumps will be subsidiary.

**5.4** The accepted quantity of roadside cleanup will be paid for at the Contract unit price per acre.

**5.4.1** When no quantity of roadside cleanup is included in the Contract, work ordered of such nature will be paid for as provided for in [109.04](#).

**5.5** Trimming of trees where directed outside of the areas measured under the item of roadside cleanup will be paid for as provided for in [109.04](#).

**5.6** Selective clearing and thinning is a final pay quantity item and will be paid at the Contract unit price per acre in accordance with [109.11](#).

**Pay items and units:**

201.01	Clearing (F)	Acre
201.02	Grubbing (F)	Acre
201.1	Clearing and Grubbing (F)	Acre
201.21	Removing Small Trees	Each
201.22	Removing Large Trees	Each
201.31	Tree Pruning, Small Trees	Each
201.32	Tree Pruning, Large Trees	Each
201.4	Removing Stumps	Each
201.51	Roadside Cleanup	Acre
201.6	Clearing for Fence Lines (F)	Acre
201.7	Selective Clearing and Thinning (F)	Acre
201.89	Fertilizing Individual Trees	Ton
-----	Trimming of Trees	Extra Work

**SECTION 202 -- REMOVAL OF STRUCTURES AND OBSTRUCTIONS****Description**

**1.1** This work shall consist of the demolition, removal and satisfactory disposal of buildings, including contents, foundations, above ground fuel storage tanks in and adjunct to buildings, decommissioning of septic systems and wells, and other obstructions pertaining thereto, as designated on the plans or in the Contract.

**1.2** The work shall also consist of the removal and salvage, satisfactory disposal of pipes or filling abandoned pipes with flowable fill, and other items as designated on the plans or ordered.

**1.3** When the item of demolishing buildings is shown as “ subject to prior removal”, the Department reserves the right to arrange for the removal or demolition of the building or buildings that have been designated on the plans to be removed by others prior to a specified date. If the buildings have not been completely removed by others prior to that date, the work to be done shall be that described in 1.1 and 1.4.

**1.4** Salvaging of designated materials; removing or breaking up, as ordered, of septic tanks; backfilling any resultant spaces, trenches, holes, or pits including dug wells and cesspools; furnishing and erecting temporary barricades; and the final grading and cleaning up of the site shall be included under this work unless such work is included under other items in the Contract.

**Material Requirements**

**2.1** Backfill material shall conform to AASHTO M 57 using the definitions given in AASHTO M 146, except the density requirements shall conform to [203.3.8](#).

**2.2** Flowable fill for filling abandoned pipes shall consist of materials conforming to [Section 520](#).

Portland Cement (Type II)	20 lb.
Ground Granulated Blast Furnace Slag	100 lb.
Sand	2,830 lb.
Water	40 - 50 gal
Air Entrainment	10 - 15 percent

**Construction Requirements****3.1 General.**

**3.1.1** The Contractor's attention is directed to [104.04](#). The Contractor must also comply with all Federal, State, and local laws and regulations for removal, transportation, and disposal of structures and obstructions. As ordered, the Contractor shall raze, remove, and dispose of all buildings and foundations, structures, guardrail, fences, and other obstructions any portions of which are on the right-of-way except utilities and those obstructions for which other provisions have been made for removal. All designated salvageable material shall be removed without unnecessary damage in sections or pieces that are readily transportable, and shall be stored by the Contractor at specified places within the project limits. Unusable perishable material shall be destroyed. Nonperishable material not designated for salvage shall be buried as directed or, with written permission of the property owner, may be disposed of off the project provided that the material remains outside the limits of view from the project, other highways, and residences. Copies of all such agreements with property owners shall be furnished to the Engineer. If disposal is by burial on private land, it must be in accordance with [106.10](#).

**3.1.2** Blasting or other operations necessary for the removal of an existing structure or obstruction, which may damage new construction, shall be completed prior to placing the new work.

**3.1.3** Foundations and holes resulting from operations, except within the limits of subsequent excavation, shall be backfilled in accordance with the provisions of [Section 203](#). If caving has occurred, the caved material shall be removed before backfilling is undertaken. All excavated material shall be used or disposed of in accordance with the provisions of [Section 203](#).

**3.2 Demolishing Buildings.**

**3.2.1** In the case of buildings to be demolished, the Engineer will notify the Contractor when any building becomes available. Upon notification of availability, ownership of the building or buildings, including all equipment, fixtures, building materials, and debris remaining on the lot, except facilities belonging to a public or private utility company, shall transfer from the State to the Contractor.

**3.2.2** The Contractor shall ascertain whether any water, sewer, gas, electric, cable TV, or telephone services are still connected to the building; if so, the Contractor shall disconnect and terminate all services in compliance with the requirements of the controlling municipality or company and then proceed with the demolition of the building.

**3.2.3** The Contractor shall protect all openings resulting from demolition or removal by use of temporary barricades as necessary for the protection and safety of the public. All barricades and obstructions shall be illuminated at night when ordered.



**3.2.4** Basements remaining in embankment areas shall be cleared of all interior partition walls and materials including but not limited to storage tanks, other equipment, and debris. When directed, to provide vertical drainage, the floor shall be thoroughly broken up into pieces no larger than 4 ft<sup>2</sup> or shall be perforated at least every 10 ft. , lengthwise and crosswise, with holes 1 ft<sup>2</sup> or more in area. Foundation walls shall be pushed in or removed to at least 1 ft. below the adjacent ground level.

**3.2.4.1** When the Engineer has ascertained that the above provisions have been complied with, the basement shall be filled to the level of the surrounding ground with the same type of material as that found at the site and shall be compacted as ordered.

**3.2.5** When the buildings have been substantially demolished and removed by others, the Engineer may require the Contractor to remove and dispose of rubbish and debris; demolish foundations; break up basement floors; clean the basement of partitions and other materials; clean up the site; and grade, loam, seed, fertilize, and mulch the area.

**3.2.6** All materials that result from building demolition shall be disposed of by an approved method. The Contractor's attention is directed to RSA 149-M in that building demolition material is classified as solid waste and as such shall be disposed of only in permitted sites. New Hampshire Department of Environmental Services, Division of Waste Management is the permitting agency.

**3.2.7** Existing sewer laterals or septic system shall be decommissioned. Existing sewer laterals shall be disconnected and capped. The septic system shall be decommissioned by pumping out the septic tank, removing or breaking up the septic tank, removing any pipes or chambers, if in existence, aerating leach field material, and burying aerated leach field material a minimum of one foot below existing ground.

**3.2.8** Existing wells shall be sealed in accordance with N.H. Water Well Board Administrative Rules, part We 604. Existing dug wells shall have the cover and well tiles removed to an elevation of two feet below the proposed roadway excavation or within two feet of the finished ground. The well shall then be backfilled with gravel free of organic matter to within two feet of roadway subgrade or finished ground in accordance with the requirements of 304.3 as appropriate. The remaining two feet outside and/or below the roadbed shall be filled with impervious material such as clay or hardpan.

**3.2.9** The Contractor shall remove any existing pump, waterline, and miscellaneous hardware from the well. The existing pump, waterline, and miscellaneous hardware removed from the well shall become the property of the Contractor, unless otherwise noted, and shall be properly disposed of according to current State and Federal regulations. The Contractor shall notify the Engineer before removing the pump.

### **3.3 Removal of Pipes and Other Drainage Structures.**

**3.3.1** Existing sewer, water, miscellaneous other pipes and appurtenances, catch basins, manholes, and other drainage structures, that are not to remain as integral parts of a drainage system, shall be removed as directed. Those under roadways in use by traffic shall not be removed until satisfactory arrangements have been made to accommodate the traffic.

**3.3.2** When the Engineer determines that sections of pipe removed are suitable for re-use, they shall be stockpiled, where directed, within the project area; when not suitable for re-use, they shall be disposed of by the Contractor. Catch basin and drop inlet grates, manhole covers, frames and all such castings, and granite curb inlets shall be carefully removed and likewise stockpiled for salvage by the State. Other parts of catch basins, drop inlets, and manholes shall be disposed of by the Contractor.

**3.3.3** Trenches and holes resulting from removal operations, except those within the limits of subsequent excavation, shall be backfilled in accordance with the provisions of 203. If caving has occurred, the caved material shall be removed before backfill is undertaken. All excavated material shall be used or disposed of in accordance with the provisions of [Section 203](#).

### **3.4 Removal of Underground Storage Fuel Tanks and Hazardous Materials.**

**3.4.1** The Contractor shall perform all work as shown on the plans and specified in the Contract.

**3.4.2** Contractor's attention is directed to the regulations that may affect the removal operations relative to contaminated soil identification, removal, and disposal; tank removal, transportation, and disposal; and site safety as follows:

National Fire Safety Code, Chapter 30, Appendix B  
 New Hampshire Hazardous Waste Rules He-P 1905  
 Water Supply WS 411  
 US Laws 49CFR 173.29 and 40CFR part 280

### **3.5 Blank.**

### **3.6 Removal of Guardrail.**

**3.6.1** Existing guardrail that is not to remain as an integral part of the Project shall be removed as specified in the Contract documents or as directed. Beam and cable guardrail, in whole or in part designated to be salvaged, shall be carefully removed and

## SECTION 202

handled in a manner that will allow reuse. Buckets, brackets, bolts, nuts, and miscellaneous hardware shall be placed in suitable containers for storage. Guardrail designated to be salvaged shall be stored in accordance with 3.1.1.

**3.6.2** Beam and cable guardrail, fittings, hardware, post, and blocks determined unfit for reuse, or not designated for salvage, shall be properly disposed of in accordance with 3.1.1.

**3.7 Abandon Pipes.** Existing pipe or drainage structures or portions thereof designated to be abandoned in place shall be filled with flowable fill.

**3.7.1** Ends of pipes and longitudinal drainage structures shall be capped or blocked closed with vents to allow air to escape and flowable fill to show when drainage structure is full.

**3.7.1.1** For pipes that are greater than 25 feet in length it will be necessary to insert a grout pipe or pull a hose through the pipe and pump the flowable fill. The Contractor may propose alternate mixes of flowable fill or grout to the Engineer for approval as a means to reduce the pumping requirements. Pipes 4 feet in diameter or greater shall be filled in two lifts. The first lift shall fill the pipe two thirds of the diameter and then be allowed to cure for a minimum of 18 hours. The remainder shall then be filled.

**3.7.2** Proportioning, batching, placing and curing of flowable fill shall conform to the appropriate sections of 520.3.

**3.7.2.1** Test data of the proposed mixture shall be submitted to the Engineer for review and approval prior to placing.

**3.8 Removal of Fences.** Existing fence that is not to remain as an integral part of the Project shall be removed and disposed of in accordance with 3.1.1 as specified in the Contract documents or as directed.

**3.9 Curb removal for salvage.** Existing curb that is not to remain as an integral part of the Project shall be carefully removed for salvage and stored as specified in the Contract documents or as directed.

### Method of Measurement

**4.1** Individual buildings, or groups of buildings when such are designated as separate units, will each be measured as a unit. When more than one unit is specified in the Contract, a separate item numbers will appear for each separate and complete unit.

**4.2** Pipe removed will be measured by the linear foot to the nearest 1 ft. within the specified size group, measured in place prior to removal if practicable; otherwise, the length of pipe removed will be computed as the product of the number of commercial lengths and the nominal lengths.

**4.2.1** All solid rock will be measured as rock structure excavation. Boulders, mortared structures such as headwalls, and the like, found to measure 1 cy or more, will also be measured as rock structure excavation when such excavation is performed for pipe removal, but pipe itself will not be measured as rock.

**4.3** Catch basins, drop inlets, and manholes removed will be measured by each. No extra measurement will be made for granite curb inlets removed unless an item therefore is included in the Contract.

**4.4** Curb removal for salvage will be measured by the linear foot to the nearest 1 ft.

**4.4.1** Removal of Bituminous curb and/or curb board with fillet will not be measured.

**4.5** Removal of guardrail will be measured, by the linear foot to the nearest 1 ft.

**4.6** Fill abandoned pipe will be measured by the cubic yard to the nearest of flowable fill based on delivery slips of material placed.

**4.6.1** Flowable fill removed because of faulty workmanship, or remaining in the delivery vehicle will not be included in the pay quantity.

### Basis of Payment

**5.1** The accepted quantities of buildings, pipes, box culverts, catch basins, drop inlets, manholes, removal of guardrail, curb removal for storage and other obstructions demolished or removed will be paid for at the Item Bid Price per unit of measurement for each of the pay items listed hereinafter.

**5.1.1** No payment will be made herein for the removal of obstructions encountered within the payment limits of another excavation item in the Contract.

**5.1.2** Removal of the pump, waterline and miscellaneous hardware from the well will be subsidiary.

**5.2** There will be no separate payment for excavation for items paid for herein except that rock measured under 4.2.1 will be paid for under 206.2.

**5.2.1** Gravel and the impervious material for backfilling the well(s) will be subsidiary.

**5.3** Existing pavement removed will be paid for under the pertinent excavation items.

5.3.1 Sawcutting pavement for removal shall be subsidiary.

5.4 The following provisions are in connection with the item of demolishing buildings:

5.4.1 There will be no separate payment for the cost of any utility work including charges, if any, that may be made by the municipality and utility companies.

5.4.2 If the bid is such that the Contractor is to pay the State, the Contractor shall indicate such payment by writing the word “credit” and deducting such amount in arriving at its total bid.

5.4.3 The State cannot assume responsibility and must be held harmless for damage to buildings or losses of or from buildings between the date of advertising for bids and the time the Contractor can take possession.

5.4.4 Work performed under 3.2.5 and 3.4 will be paid for either under pertinent items of the Contract or as provided under 109.04.

5.5 When no basis of payment for the removal of structures and obstructions is included in the Contract, such work will be subsidiary except as provided for in 5.4.4.

5.6 Removal of guardrail will be paid for at the Contract unit price per linear foot.

5.6.1 Removal of bituminous curb and/or curb board with fillet will be paid for under the excavation item unless otherwise specified in the plans.

5.6.2 No separate payment will be made for the removal of guardrail anchors or terminal units.

5.7 There will be no separate payment for backfill material and such work will be subsidiary to the respective removal item.

5.8 There will be no separate payment for decommissioning sewer laterals or septic systems and such work will be subsidiary to demolishing buildings.

5.9 The accepted quantities of fill abandoned pipe or drainage structure will be paid for at the Contract unit price per cubic yard complete in place. Capping or blocking, installation of grout pipes or hoses, vents and pumping will be subsidiary.

**Pay items and units:**

202.1XX	Demolishing Buildings Subject to Prior Removal	Unit
202.2	Demolishing Buildings	Unit
202.2XX	Demolishing Buildings	Unit
202.31	Fill Abandoned Pipe	Cubic Yard
202.32	Fill and Abandon Structure	Cubic Yard
202.41	Removal of Existing Pipe 0 to 24” Diameter	Linear Foot
202.42	Removal of Existing Pipe Over 24” Diameter	Linear Foot
202.5	Removal of Catch Basins, Drop Inlets, and Manholes	Each
202.51	Removal of Granite Curb Inlets	Each
202.6	Curb Removal for Salvage	Linear Foot
202.7	Removal of Guardrail	Linear Foot
202.9	Removal of Fuel Tanks	Unit

**SECTION 203 -- EXCAVATION AND EMBANKMENT****Description**

**1.1** This work shall consist of excavation of all material not being removed under some other item, placement and compaction of all material required for the work, and necessary disposal of all other material. The excavation will be classified as described below. Embankment-in-place shall consist of furnishing, placing and compacting the total volume of embankment material required to construct fills below subgrade and within template lines as shown on the plans excluding slope protection measures and landscaping treatments paid under separate items.

**1.2** This work shall consist of constructing guardrail terminal unit platforms, offset platforms for EAGRT terminal and Smart Workzone (SWZ) device platforms as shown on the plans or as ordered.

**Classification of Material**

**2.1** Common excavation shall consist of all excavation not included as rock excavation or not otherwise classified. Glacial till or boulder clay will be considered as common excavation.

**2.2** Rock excavation shall consist of all solid rock that cannot be removed without blasting or ripping. It shall also consist of boulders and parts of masonry structures, except unreinforced concrete slabs less than 6" in depth, when found to measure 2 cy or more.

**2.3** Unclassified excavation shall consist of all materials of whatever character encountered in the work.

**2.4** Muck shall consist of deposits of saturated or unsaturated organic soils having an organic content of 20 percent or greater by weight as determined by AASHTO T 267 and is greater than 2 feet thick when in the upper soil profile (topsoil) and is determined to be unsuitable for foundation material. The material contains partially decayed organic matter, is fibrous in texture, dark brown or black in color, and has an odor of decay.

**2.5** Embankment material shall conform to AASHTO M 57 using the definitions given in AASHTO M 146, except the density requirements shall conform to [203.3.8](#).

**2.6** Concrete class F, flowable fill may be requested in writing as a substitute for embankment. Approval shall be in consideration of, but not limited to, differential frost heaving due to dissimilar materials, unit weight, structural requirements, lack of permeability, and damming resulting from water flow cut off.

**2.7** Unsuitable material shall consist of any saturated or unsaturated natural or man-made material such as, but not limited to, stumps, vegetation, demolition debris and structures encountered during the work that the Engineer determines to be unsuitable for foundation material.

**2.8** Gravel and crushed gravel for shoulder leveling for guardrail and SWZ device platforms shall conform to [304.2.4](#) and [304.2.6](#) respectively.

**Construction Requirements**

**3.1 General.** The excavation and embankments shall be finished to reasonably smooth and uniform surfaces.

**3.1.1 Conservation of growth.** Excavation shall be carefully performed in the proximity of trees and shrubs designated to be saved on the plans or as ordered. Any roots that have to be removed shall be cleanly cut, and the larger roots shall be painted with approved wood dressing or treated according to other accepted arboricultural practices.

**3.1.2 Topsoil and other humus material.** Topsoil and desirable humus material shall be removed in excavation areas and also in fill areas to such depths as the Engineer may direct. Such material shall be reserved and shall be stockpiled in accessible piles that can be measured readily and accurately by the Engineer. Unless otherwise permitted, each stockpile shall contain a minimum of 200 cy, and have a height of at least 4 ft.

**3.1.3 Material found in the roadway.** Sand, gravel, or other materials found in the roadway may be used under the specific item in accordance with [104.04](#) when permitted.

**3.1.4 Removing abandoned road surface.** Old road surfaces shown or ordered to be removed shall be stripped neatly to the depth and width as shown on the plans or as ordered.

**3.1.5 Drives.** Drives shall be retained or constructed as shown on the plans or as ordered.

**3.2 Rock Excavation.**

When rock excavation is to be performed, the overburden shall be removed, or trenches shall be excavated through the overburden at the intervals directed, normally 25 ft., but in no case closer than 10 ft. apart to permit cross-sectioning of the rock in

its original position. The use of power equipment will be satisfactory. Rock removed prior to sectioning will be considered as common excavation.

### 3.2.1 Blasting operations.

The required slopes or configurations shown on the plans or ordered shall be constructed in a safe and stable condition while ensuring the safety and convenience of the public.

**3.2.1.1** The Engineer will, at all times, have the authority to prohibit or halt the Contractor's blasting operations if it is apparent that through the methods being employed, the required slopes are not being obtained in a stable condition or the safety and convenience of the public is being jeopardized.

**3.2.1.2** The Contractor shall schedule blasting operations so that all rock excavation within 300 ft. of any portion of a proposed bridge or within 100 ft. of any other proposed structure is completed before any structure work is started.

**3.2.1.3** All blasting operations, including the storage and handling of explosives and blasting agents, shall be performed in accordance with the applicable provisions of the Standard Specifications and all other pertinent Federal, State, and local regulations. Whenever explosives are used, they shall be of such character and in such amount as are permitted by the State and local laws and ordinances, and all respective agencies having jurisdiction over them.

**3.2.1.4 Pre-blast meeting.** A pre-blast meeting shall be held prior to the start of any drilling or blasting activities. The purpose of the meeting shall be to review the blasting procedures and vibration monitoring requirements and to facilitate coordination between all parties involved. Individuals attending the pre-blast meeting should include the Contract Administrator, the Contractor, the Contractor's seismologist or blasting consultant, the Contractor's blaster, the Research Geologist, any utility affected by the blasting operation, and any other personnel the Engineer deems appropriate.

**3.2.1.5** The Contractor shall observe the entire blast area to guard against potential hazards before commencing work in the cut. The Contractor shall not be allowed to store explosives on the project site or on State owned property unless prior approval is granted by the Department.

**3.2.1.6 Blast scheduling.** The Contractor shall notify the Engineer of blast round schedules in accordance with the following requirements:

- (a) At least 24 hours in advance, notification of estimated time of blast.
- (b) At 1 hour prior to a blast, stand-by notification.

**3.2.1.7** All loose and unstable material, all breakage, and all potentially unstable rock slides, even if located beyond the payment lines, shall be removed or stabilized to the Engineer's satisfaction during or upon completion of the excavation in each lift. Drilling the next lift will not be allowed until this work has been completed. It shall be the responsibility of the Contractor to perform all phases of this work to produce the required slopes.

**3.2.1.8** Prior to the start of blasting activities, the Contractor shall place an advertisement in the local newspaper and provide a notice to adjacent property owners or tenants identifying the project, blasting Contractor, site location, warning signals, and precautions being taken by the blasting Contractor to minimize disturbance to residents.

### 3.2.2 General Blasting Plan.

The Contractor shall submit the General Blasting Plan for review and approval to the Research Geologist at the Bureau of Materials and Research. The General Blasting Plan shall be submitted at least two weeks prior to commencing drilling and blasting operations. No drilling or blasting shall take place until the general Blasting Plan is approved by the Research Geologist. The General Blasting Plan shall include the following information:

- (a) A diagrammatic description of the "Typical Blasting Pattern" to be used for the required rock excavation, including the presplitting pattern if presplitting is required (See 3.2.9). This description shall include the spacing and depth dimensions both for the holes drilled along the presplit lines (presplit holes) and for fragmentation charge holes (production holes). The relative position of the "free face" and the burden shall also be shown, along with the anticipated cap delays to be used at each hole in the pattern. An example of such a diagrammatic plan is shown in Figure 1.
- (b) A diagrammatic description of the loading plan for a "Typical Production Hole" and, if presplitting is required on the project, for a "Typical Presplit Hole". This description shall include for each type of hole the fuse and cap locations, the percent strength and type of primer, the proposed hole diameter, the percent strength and type of explosives, with brand name and density of explosive, and the anticipated location and depth of stemming. An example of such a diagrammatic plan is shown in Figure 2.
- (c) Subdrilling depth; amount of explosives, primers, and initiators in each hole; initiation sequence of blastholes including delay times and delay system; and manufacturer's data sheets for all explosives, primers, and initiators to be used.

## SECTION 203

- (d) Sequence and schedule of production blast rounds, including the general method of developing the excavation, lift heights, starting locations, estimated starting dates, estimated rates of progress, etc.
- (e) Written evidence of the licensing, experience, and qualifications of the blaster who shall be directly responsible for the handling, use and security of explosives along with the coordinating, planning and supervising the explosive use and loading and firing of each shot, herein referred to as the blaster-in-charge. The blaster-in-charge or alternate blaster-in-charge is required to be on-site during all blasting. All acting blasters-in-charge must be pre-approved by the Department.
- (f) Name and qualification of the person responsible for designing and directing the Contractor's blasting operation.
- (g) Name and qualifications of the independent seismologist or blasting consultant proposed for use in conducting pre-blast condition surveys.
- (h) Name and qualifications of the independent seismologist or blasting consultant proposed for use in monitoring blast vibration. (See 3.3) A sample of a previous vibration analysis or report or both shall be included with the qualifications. The seismologist or blasting consultant shall be subject to the Engineer's approval.
- (i) Listing of instrumentation which the seismologist or blasting consultant proposes to use to monitor vibrations together with performance specifications, instrumentation user's manual supplied by the manufacturer(s). (See 3.3.7)
- (j) A complete description of the clearing and guarding procedures that will be employed to ensure personnel, staff, visitors, and all other persons are at a safe location during blasting. This includes details regarding traffic control, visible warning signs or flags, audible warning signals, method of determining blast areas, access blocking methods, how the blaster in charge will communicate with site personnel or other appropriate site supervisory personnel.
- (k) A summary of the proper safeguards for personnel in the event of a misfire until the misfire can be re-blasted or safely removed.
- (l) Communication protocol between vehicles and office facilities including cease use restrictions during blasting activities.
- (m) Proposed vibration monitoring locations.
- (n) Predicted PPV values. The scaled distance shall be included and use the following formulas:

$$PPV = K(Ds)^m \quad \text{and} \quad Ds = D/(W_{max})^{0.5}$$

where: PPV = Peak Particle Velocity (in/sec)

K and m = Site specific constants defining initial energy and decay

Ds = Scaled Distance (ft/lb<sup>0.5</sup>)

D = Distance to subject structure (ft)

W<sub>max</sub> = Maximum charge per delay (lbs)

Default values of K = 242 and m = (-1.6) may be used for the equation above. However, K and m are site specific and shall be determined by performing a regression analysis of multiple PPV and Ds data pairs. Proposed K and m values shall be replaced by the site specific values determined after the initial 2 or 3 blasts at each separate blast location, and shall be re-evaluated and adjusted as necessary based on actual site conditions, rock type and structure, subsurface information and blast monitoring measurements.

**3.2.2.1** The General Blasting Plan shall form the basis for all blasting operations on the project. If, in the judgment of either the Engineer or the Contractor, changes in the plan appear to be necessary, drilling or blasting operations shall be suspended and a revised plan shall be submitted to the Engineer reflecting the proposed changes. No further drilling or blasting shall take place until approval of the revisions is received from the Engineer.

**3.2.2.2** In addition to the General Blasting Plan approval, a site specific Blasting Plan approval will be required for critical locations as deemed necessary by the Engineer or the Contractor. The Site Specific Blasting Plan shall be submitted at least 24 hours before the start of drilling and shall include proposed modifications to the General Blasting Plan requirements listed in 3.2.2. Site specific Blasting Plans may be waived for non-critical areas as determined by the Engineer.

**3.2.2.3** Approval of the Blasting Plan shall not relieve the Contractor of full and complete responsibility for the results of the blasting operations. The Contractor also has full responsibility for the accuracy and adequacy of the Blasting Plan when implemented in the field. (See 107.08)

### **3.2.3 Responsibility for blasting operations.**

Review of the Contractor's blasting submittals by the Department or its Engineer shall not relieve the Contractor of its responsibility for the accuracy, adequacy, and safety of the blasting; for exercising proper supervision and field judgment; for preventing damage to structures; or for producing results in accordance with the State of New Hampshire regulations and NHDOT Specifications. The blasting Contractor shall be solely and completely responsible for the safety of all persons and property during the performance of its work. The Contractor shall take whatever measures it deems necessary, in addition to the requirements herein, to protect the safety of persons and property, both at the construction site and away from the site. The Contractor shall have full and complete responsibility for the handling, discharging, or settling of any and all damage or annoyance claims resulting

from the blasting activities on the project. Any monitoring and/or review of the Contractor's procedures and performance conducted by the Department or its Engineer shall not relieve the Contractor of its responsibility for safety at and away from the site, or for preventing damage to adjacent structures or property.

**3.2.4** Drill hole conditions may vary from dry to filled with water. The Contractor shall be required to use whatever type(s) of explosives and/or blasting accessories necessary to accomplish the specified results.

**3.2.5** All space in each blast hole not occupied by the explosive charges shall be filled with stemming material. Stemming material shall be clean stone chips or other approved angular, granular material as shown in Table 203-1.

**Table 203-1 -- Required Grading of Stemming Material**

Sieve Size	Percentage by Weight Passing
3/8 in	100
No. 4	20 - 25
No. 8	0 - 10

**3.2.6** Prior to commencing full-scale blasting operations, the Contractor shall demonstrate the adequacy of the proposed Blasting Plan by drilling, blasting, and excavating short test sections, up to 100 ft. in length, to determine which combination of method, hole spacing, and charge works best. When field conditions warrant, as determined by the Engineer, the Contractor may be ordered to use test section lengths more than 100 ft. The Engineer will have the authority to eliminate the test shot(s) if conditions warrant. Requirements for controlled and production blasting operations covered elsewhere in this specification shall also apply to the blasting carried out in conjunction with the test shots.

**3.2.7** The Contractor shall not be allowed to drill ahead of the test shot area until the test section has been excavated and the results evaluated by the Engineer. If the results of the test shot(s), in the opinion of the Engineer, are unsatisfactory, then the Contractor shall adopt such revised methods as are necessary to achieve the required results. Unsatisfactory test shot results include an excessive amount of fragmentation beyond the indicated lines and grade, excessive flyrock, and/or violation of other requirements within these specifications.

### **3.2.8 Blasting Safety.**

**3.2.8.1 Warning signals.** Adequate warnings in accordance with OSHA regulation 1926.909 shall be given to all personnel in proximity to the blast site at least three minutes in advance of each blast.

**3.2.8.2 Flyrock control.** Flyrock shall be controlled through proper blast design. Before the firing of any blast in areas where flying rock or debris may result in personal injury or damage to property, the rock to be blasted shall be covered with approved blasting mats, soil, or other equally serviceable material to prevent flyrock. The method of flyrock control shall be subject to approval by the Engineer.

### **3.2.9 Controlled Blasting.**

**3.2.9.1 Presplitting.** Presplitting shall be required in rock slopes where the designed slope is 1:2 (horizontal to vertical) or steeper and the rock is 10 ft. or more in depth above the subgrade, measured along the slope.

**3.2.9.2** Presplitting is defined as the establishment of a free surface of a shear plane in rock by the controlled usage of explosives and blasting accessories in appropriately aligned and spaced drill holes so that the resulting split rock is not affected by subsequent blasting and excavation operations adjacent thereto (See Figure 1). The purpose of presplitting is to minimize damage to the rock backslope and to help ensure long-term stability. When presplitting, the detonation of the presplit line shall be before the detonation of any production holes. Production blasting refers to the main fragmentation blasting resulting from more widely spaced production holes drilled throughout the main excavation area adjacent to the presplit line. Production holes shall be detonated in a controlled delay sequence.

**3.2.9.3** Prior to drilling, all overburden and all loose and disintegrated rock shall be removed down to solid rock in the vicinity of the presplit lines as shown on the plans. Potentially dangerous boulders beyond the excavation limits shall also be removed as ordered.

**3.2.9.4** Presplitting shall extend a minimum of 50 ft. ahead of the limits of fragmentation blasting within the section, unless otherwise permitted.

**3.2.9.5** Unless otherwise approved, holes not greater than 3" in nominal diameter, and spaced 36" on center, shall be drilled along the presplit line and at the required slope inclination to the full depth of the cut or to a predetermined stage (lift) elevation. The proper angle of drilling shall be maintained at all times so that each presplitting hole is parallel to its adjacent one and does not deviate more than 1 ft. in 35 ft., either in the plane of the specified slope line or in its vertical alignment. The toe of the

## SECTION 203

completed slope shall coincide, within those limits, with the toe of the slope shown on the plans. All drilling equipment used to drill presplit holes shall have mechanical or electrical devices affixed to the equipment to accurately determine the angle at which the drill steel enters the rock, unless alternate methods for aligning the drill steel are approved by the Engineer.

**3.2.9.6** The spacing of the blast holes specified above, the distribution and type of explosives, methods of detonation, and blasting techniques specified below shall be adjusted as necessary according to the breakage characteristics and structure of the bedrock encountered so as to presplit the rock along the required face.

**3.2.9.7** Presplitting holes shall not exceed 35 ft. in depth unless permitted. Rock deeper than 35 ft. shall be presplit in lifts, but no lift shall be less than 10 ft. in depth. Should the Contractor desire to forego presplitting in lifts, the Contractor shall propose it as part of the Blasting Plan, stating specific reasons for blasting at depths greater than 35 ft. in one lift. If approved, the approval shall be on a trial basis. The first 50 ft. of presplitting greater than 35 ft. in depth will be reviewed by either of the methods described in 3.2.9.9, but preferably by excavation and exposure. Further presplitting will not be allowed until the trial section has been reviewed to the Engineer's satisfaction. Subsequent presplitting will occur in this manner, with each section being no greater than 50 ft, throughout the sections where presplitting holes exceed 35 ft. in depth. No payment will be made for additional excavated quantity caused by offsetting of presplit holes beyond the specified presplit lines in the top or successive lifts. Presplitting holes in successive lifts shall be designed to offset 2 ft. inside of the previously presplit face.

**3.2.9.8** Before placing the charge, each hole shall be inspected and tested for its entire length to ascertain the possible presence of any obstructions. No loading shall be permitted until the hole is free of all obstructions for its entire depth. All necessary precautions shall be exercised so as to prevent debris from falling into holes prior to loading and so that the placing of the charge does not cause caving of material from the walls of the hole.

**3.2.9.9** Results of presplitting shall be exposed for the Engineer's examination and evaluation. Based upon the Engineer's judgment of results obtained during the progress of the excavation, changes ordered in drilling or blasting methods shall be implemented by the Contractor. If the presplit face is not going to be exposed for immediate inspection and evaluation, the Engineer may require the results of a bore hole deviation measuring survey to verify the proper spacing and orientation of the presplit holes.

**3.2.9.10** Continuous column cartridge explosives manufactured especially for presplitting shall be used for all presplitting. The maximum diameter of explosives used in presplit holes shall not be greater than one-half the diameter of the presplit hole, unless otherwise approved. The bottom charge of a presplit hole may be larger than the line charges but shall not be large enough to cause overbreak. The upper portion of all presplit holes, from the top most charge to the hole collar, shall be stemmed. Unloaded and unstemmed guide holes (gas release holes), when used between presplit holes, shall be drilled in the same plane and to the same tolerance as the presplit holes. The guide holes shall extend the full depth of the lift, unless otherwise permitted.

**3.2.9.11** If presplitting charges are fired with detonating cord, the cord shall extend the full depth of each hole. If full or fractional portions of dynamite cartridges are used with detonating cord, the dynamite shall be securely affixed to the cord.

**3.2.9.12** All presplit holes may be detonated simultaneously or delayed providing the hole to hole delay is no more than 25 milliseconds. The detonation of presplit charges shall precede the detonation of adjacent fragmentation charges within the section by a minimum of 25 milliseconds.

**3.2.9.13** The line of blast holes immediately adjacent to the presplitting slope holes shall be drilled 4 ft. from and on a plane approximately parallel to the plane of the presplitting slope holes. No portion of these holes or any other blast holes shall be permitted closer than 4 ft. to the presplit lines. All precautions as necessary shall be taken so as to avoid fracturing the rock beyond the presplit face.

**3.2.9.14** The Engineer may order the discontinuance of the presplitting operations when the rock formation is of such character that no apparent advantage is gained.

**3.2.9.15** The Contractor may use cushion (trim) blasting if conditions warrant it and if, in the opinion of the Engineer, satisfactory results are obtained during the test shot(s). Cushion blasting is similar to presplitting except that the detonation along the cut face shall be performed after the detonation of all production holes. Difference in delay time between the trim line and the nearest production row shall not be greater than 75 milliseconds nor less than 25 milliseconds. With the exception of the above criteria, requirements previously given for presplitting shall also apply to cushion blasting.

### **3.2.10 Rock Excavation Record Keeping**

**3.2.10.1 Blasting log.** A blasting log must be completed daily for every primary blast, and copies must be provided to the Engineer. An example of a typical blasting log is shown in Figure 3. The drilling Contractor may use a different format for its blasting log if it has been approved by the Engineer.

**3.2.10.2** Within 24 hours following each blast, the Contractor shall submit to the Engineer in writing the following items:



- (a) Details of the shot shall include the information shown on the sample blasting log (See Figure 3).
- (b) Results of blast monitoring at each instrument location and distance from the blast, including PPV in inches per second, as well as a copy of the strip chart recording for each monitoring location, marked with the date, time, location of the equipment, and signature and name of seismograph operator.

### 3.2.11 Best Management Procedures for blasting.

The Contractor shall follow Best Management Procedures (BMP's) to include preparing, reviewing and following an approved General Blasting Plan; proper drilling, explosive handling and loading procedures; observing the entire blasting procedures; evaluating blasting performance; and proper excavation, stockpiling, processing and use of blasted rock. Best Management Procedures will be considered subsidiary to all rock excavation items.

**3.2.11.1 Loading practices.** The Contractor shall utilize the following loading practices to minimize environmental effects:

- (a) Blastholes shall be drilled within one foot of the intended blast pattern.
- (b) Blastholes shall be within five (5) degrees of the intended orientation.
- (c) Blasthole boring logs shall be maintained by the driller and communicated directly to the blaster. The logs shall indicate depths and lengths of voids, cavities, and fault zones or other weak zones encountered as well as groundwater conditions.
- (d) Unpackaged/unsleeved ANFO and emulsions shall not be used if artesian or water flowing conditions are encountered.
- (e) Loaded explosives shall be detonated as soon as possible and shall not be left in the blastholes overnight.

**3.2.11.2 Ammonium Nitrate and Fuel Oil (ANFO).** The following BMP's shall be followed to reduce nitrate impacts when ANFO is used:

- Identify blastholes containing water and remove water prior to loading with ANFO.
- Water resistant ANFO (ANFO-WR) shall be used in blastholes that recharge with groundwater and remain wet even after pumping.
- Spills of ANFO or other blasting agents, at the ground surface around the blasthole collars shall be cleaned up promptly and either reused or taken off site.
- Adequate unloaded collar lengths shall be established to reduce both "blowback" when loading pneumatically and blasthole proximity effects.
- Proper "standoff" distance and loading vessel pressure shall be maintained to reduce "blowback" during pneumatically loading ANFO.
- Partially used bags of ANFO shall be resealed and returned to the explosive magazine.
- Loading equipment shall be cleaned in an area where the water can be properly contained and handled in a manner that prevents releases.
- Explosives shall only be delivered to the site in approved magazine trucks and should not be stored overnight on-site.

**3.2.11.3 Bulk emulsions and slurry/watergel explosives.** The following BMP's shall be followed to reduce nitrate impacts when bulk emulsions or slurry/watergel explosives are used:

- Spills of the product shall be removed from the spillage area, and either reused or taken off site for disposal.
- Proper loading techniques shall be followed when loading a bulk product into a wet blasthole. The bulk liquid product should be extruded into itself from the bottom of the blasthole and not into the standing water above the product.
- If groundwater conditions are severe, e.g., artesian/flowing conditions, packaged explosives (emulsions, watergels, slurries, blends, cartridge, etc.) shall be used instead of bulk products or as required by the Engineer.

**3.2.11.4 Blasthole stemming.** The following BMP's shall be followed when placing stemming in blastholes:

- Blastholes shall be cleaned out thoroughly using the compressed air stream from the drill to remove the drill cuttings.
- Drill cuttings shall not be used as stemming.
- Stemming shall be placed to prevent bridging, and shall be appropriately sized for the blasthole diameter.
- Blastholes shall be completely stemmed to prevent incomplete detonation.
- Weak zones, voids, and cavities shall be stemmed as decks to prevent the loss of explosive products into the bedrock.

**3.2.11.5 Misfires.** One or more of the following BMP's shall be followed to help prevent misfires:

- Use of redundant surface delays to connect blastholes if shifting mats, uneven terrain or other conditions could cause cut-offs.
- Double or triple priming of the blastholes.
- Use of an electric detonating system.

**SECTION 203**

- Use of a programmable electronic detonating system.
- Or a method proposed by the Contractor.

**3.2.11.6** Fragmented blast rock excavation, handling, stockpiling, processing and use. The following BMP's shall be followed when excavating, handling, stockpiling, processing or using blasted rock fragments on site.

- Remove the blasted rock (muckpile) from the blast area immediately after blasting.
- Distribute rock fragments and processed blasted rock widely throughout the project in fill areas as soon as possible.
- If the blasted rock will not be reused on site, remove the muckpile/processed rock from the project site as soon as possible.

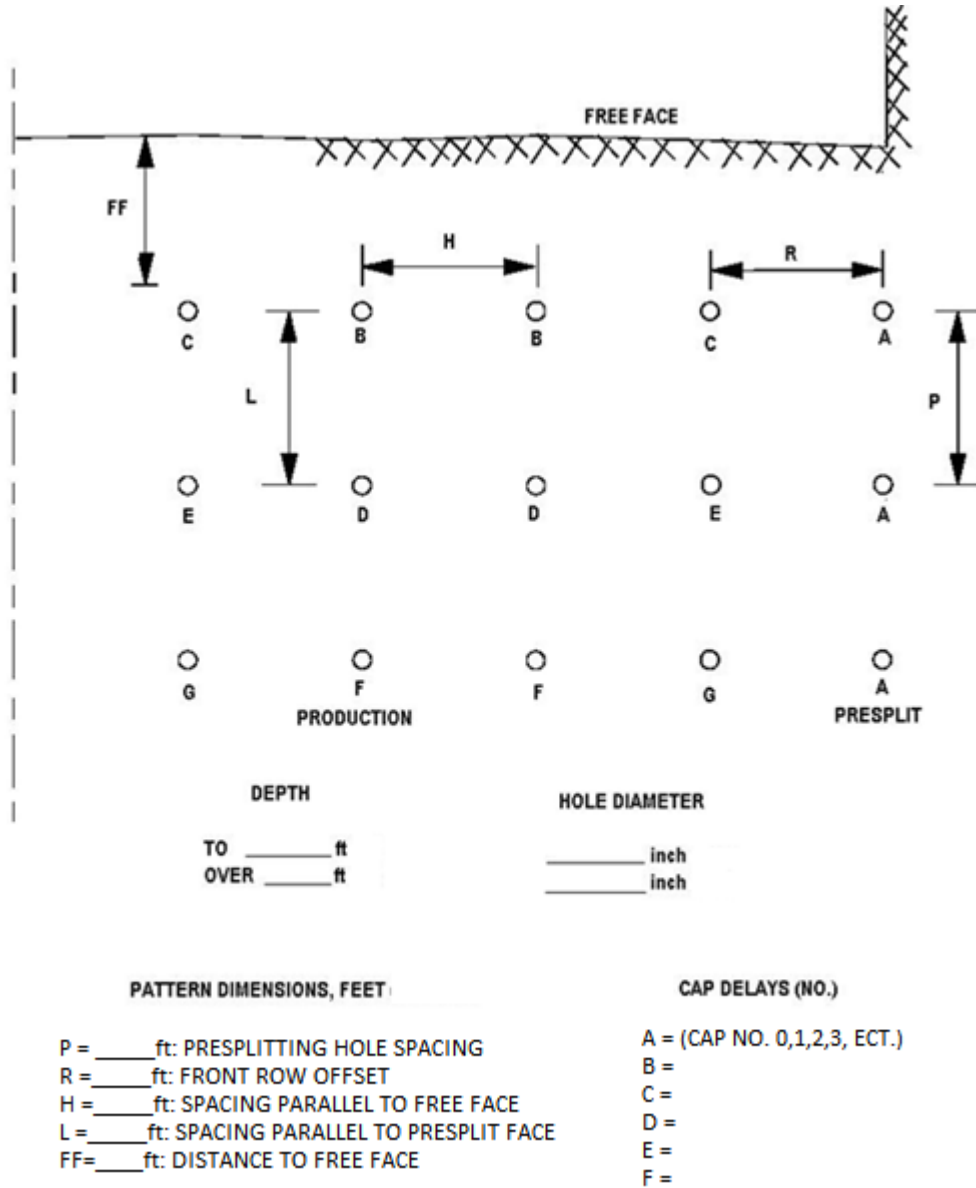

**FIGURE 1 – TYPICAL BLASTING PATTERN**

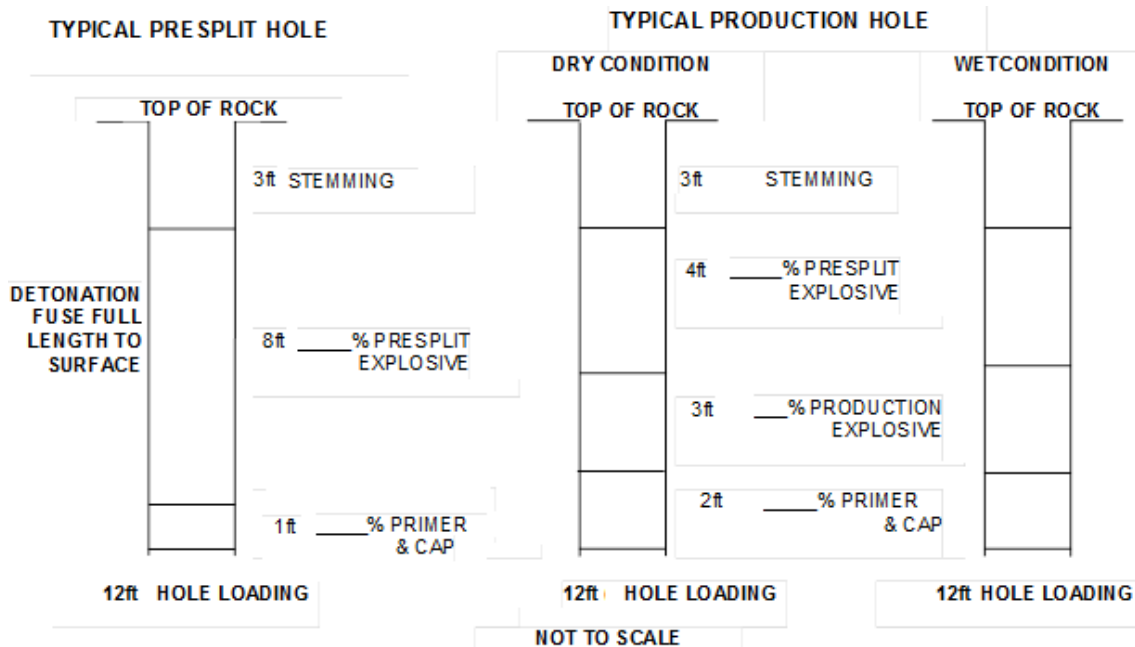

**FIGURE 2 – SAMPLE LOADING PLAN**

Note: All dimensions, configurations, and loadings shown are intended only as examples of diagrammatic description and should not be construed as indicating any suggested drilling or loading plan.

**FIGURE 3 - BLASTING LOG**

NHDOT Project Name \_\_\_\_\_

Federal Project No. \_\_\_\_\_ State Project No. \_\_\_\_\_

1. Company Name: \_\_\_\_\_

2. Location of Shot (Stations): \_\_\_\_\_

3. Shot Number: \_\_\_\_\_ 4. Time: \_\_\_\_\_ 5. Date: \_\_\_\_\_

6. Weather: \_\_\_\_\_

7. Wind Direction: \_\_\_\_\_ 8. Temperature: \_\_\_\_\_

9. Distance & Direction to Nearest Structure: \_\_\_\_\_ & \_\_\_\_\_

10. Depth of Water - Ft: \_\_\_\_\_

11. Total Explosives Allowed Per Delay Period:

$$\text{Weight of Explosive(s) (lb)} = \left[ \frac{\text{Distance in Feet}^*}{50} \right]^2 = \underline{\hspace{2cm}}$$

\* Distance is to the nearest structure.

12. Diameter of Holes - in: Production \_\_\_\_\_ Presplit \_\_\_\_\_

13. Depth of Holes - ft: \_\_\_\_\_

14. Total Number of Holes: \_\_\_\_\_

15. Drill Pattern – Burden times Spacing - ft: \_\_\_\_\_

16. Type and Height of Stemming - ft: \_\_\_\_\_

**SECTION 203**

- 17. Depth of Sub-Drilling - ft: \_\_\_\_\_
- 18. Mats or Other Protection Used: \_\_\_\_\_
- 19. Types of Explosive(s) Used: Presplit \_\_\_\_\_  
Production \_\_\_\_\_
- 20. Density of Explosive(s) Used: \_\_\_\_\_
- 21. Kind of Delay Periods: \_\_\_\_\_
- 22. Total Number of Delay Periods: \_\_\_\_\_
- 23. Length of Delay Periods (milliseconds): \_\_\_\_\_
- 24. Total Amount of Explosives Used - lbs: \_\_\_\_\_
- 25. Maximum Number of Holes Per Delay Period: \_\_\_\_\_
- 26. Maximum Amount of Explosive(s) Per Delay Period – lbs: \_\_\_\_\_
- 27. Powder Factor =  $\frac{\text{Pounds of Explosives Per Hole}}{\text{Cubic Yards of Rock Per Hole}}$   
Powder Factor (lbs/cy) = \_\_\_\_\_
- 28. Scale Distance =  $\frac{\text{Distance in Feet}}{\sqrt{\text{Weight Per Delay Period in Pounds}}}$
- 29. Method of Firing: \_\_\_\_\_
- 30. Number of Series Circuits: \_\_\_\_\_
- 31. Location of Seismograph: \_\_\_\_\_

- a. Distance from Shot and Direction: \_\_\_\_\_
- b. Person Taking Reading: \_\_\_\_\_
- c. Seismograph Reading: \_\_\_\_\_
- d. Peak Sound Pressure Levels: \_\_\_\_\_
- e. Vibration Measurements: \_\_\_\_\_

Transverse  
Vertical  
Longitudinal

**DIAGRAM OF SHOT**

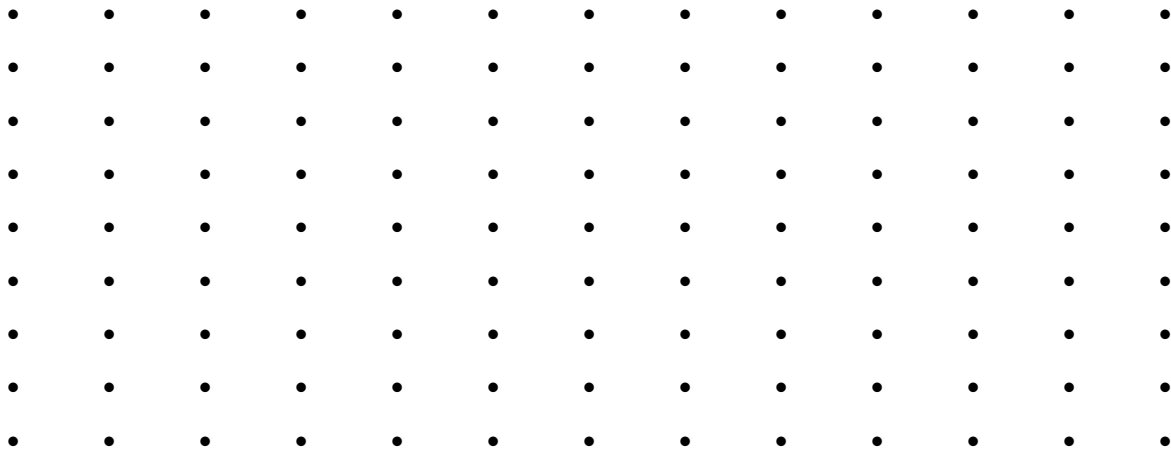

Name of Blaster: \_\_\_\_\_

License Number of Blaster: \_\_\_\_\_

### 3.3 Blast vibration control and monitoring.

The Contractor shall be required to comply with the blasting vibration limits established herein. The vibration limits shall be incorporated in the Contractor's Blasting Plan, as required. The Contractor shall provide for monitoring of the blasting vibrations (both ground and air concussions) produced as a result of the construction activities and shall provide Pre-Blast Condition surveys of structures. The Contractor shall cooperate in adjusting the Blasting Plan and procedures to maintain the vibration limits specified herein and to minimize vibration-related claims and complaints.

**3.3.1 Seismologist or Blasting Consultant.** The Contractor shall retain a seismologist or blasting consultant to monitor, record, analyze, and report the seismic vibrations being caused by blasting activities. The name and résumé of qualifications of the seismologist or blasting consultant shall be submitted to the Engineer for approval no later than the preblast meeting. No drilling or blasting shall take place until such approval is given. The seismologist or blasting consultant shall not be an employee of the Contractor, Subcontractor, explosives manufacturer, or explosives distributor.

**3.3.2 Seismologist or Blasting Consultant qualifications.** The seismologist or blasting consultant shall be experienced in the subject of vibrations emanating from blasting activities. The seismologist or blasting consultant shall be qualified to thoroughly analyze seismic parameters of the energy source, the energy transmission path, the recording site, and the ground motion spectra. The minimum qualifying requirement to perform the necessary documentation and analysis is a Bachelor of Science degree with accredited course work in at least three of the following disciplines: Seismology, Geophysics, Geophysical Data Processing, Geomechanics, Geophysical Engineering, Vibration Engineering, Soil and/or Rock Mechanics, Foundation and/or Explosive Engineering, Advanced Calculus, and Time-Series (Fourier) Analysis.

**3.3.3 Seismologist or Blasting Consultant duties.** The seismologist or blasting consultant shall direct and instruct the Contractor in its operations to control vibrations within acceptable levels. The seismologist or blasting consultant shall be in charge of making the preliminary blast survey and, unless otherwise permitted in writing, shall be present at the site of the blasting during all blasts. The seismologist or blasting consultant shall provide and use all necessary equipment to observe and record vibrations to ascertain that acceptable levels of vibrations are not exceeded. The seismologist or blasting consultant shall monitor, report findings, and submit recommendations on a daily basis to the Engineer. The seismologist or blasting consultant shall determine the level of observed vibrations attributed to the project's blasting activities and their subsequent effect on surrounding structures. The seismologist or blasting consultant shall make recommendations for vibration limits to protect sensitive equipment and manufacturing processes if limits have not been predetermined. Written justification shall be provided for all recommendations.

**3.3.3.1 Pre-blast condition survey.** The seismologist or blasting consultant shall conduct a pre-blast condition survey of all existing structures and conditions on the site, adjacent to the site, or in the vicinity of the site. This survey shall extend to such structures or conditions as may be affected by the Contractor's construction operations. As a minimum, condition surveys shall be performed on all structures, including swimming pools and mobile homes, within 500 ft. of anticipated blasting areas.

**3.3.3.2** The pre-blast condition survey shall consist of a written description of the interior and exterior condition of each of the structures examined. Descriptions shall locate any existing cracks, damage, or other defects and shall include such information so as to make it possible to determine the effect, if any, of the construction operations on the defect. Particular note shall be made of evident structural faults and deficiencies, or recent repairs. Where significant cracks or damage exist, or for defects too complicated to document in words only, sketches and photographs shall be taken or a good quality videotape survey with appropriate audio description of locations, conditions, and defects shall be performed to supplement the written description. Pictures and sketches shall be provided with a scale where practical. Prior to the start of work, a copy of the pre-blast condition survey shall be submitted to the Engineer for review.

**3.3.3.3** The seismologist or blasting consultant shall give written notice to the owner of the property concerned, tenants of the property, and any representative of local authorities required to be present at the pre-blast survey. The notice shall state the dates on which surveys are to be made. Copies of all notices shall be provided to the Engineer.

**3.3.3.4 Report of monitoring results.** Following each blast, the seismologist or blasting consultant shall immediately report the measured vibrations to the Engineer. In the event seismic vibrations caused by the Contractor's operations approach the established limits for this project, the Engineer may require the Contractor to modify the blasting operations to reduce the vibrations. If the seismic ground vibration or air concussions or both ground vibration and air concussions caused by the Contractor's blasting operation attain or surpass the established limits, the operations shall cease. Blasting shall not be resumed until measures have been taken to reduce, to the satisfaction of the Engineer, the produced vibrations and/or air concussions below the established limits. The seismologist or blasting consultant should assist the Contractor in the design of the Contractor's blasting to eliminate the problems and to avoid liability claims.

**3.3.3.5 Post-blast condition survey.** Upon completion of all earth/rock excavation and blasting work, the seismologist or blasting consultant shall conduct a post-blast condition survey of any properties, structures, and conditions for which complaints of damage have been received or damage claims have been filed. Notice shall be given to all interested parties so that they may

**SECTION 203**

be present during the final examination. Records of the final examination shall be distributed the same as the original pre-blast condition survey.

**3.3.4 Monitoring locations.** At a minimum, one seismograph shall be located at the nearest structure or as directed by the Engineer. Up to a total of three seismographs may be required to optimize blast efficiency while achieving vibration control. Additional seismographs may be required for setup at complaint locations.

**3.3.5 Ground vibration limits.** The ground vibration limits herein are based on published USBM RI8507 alternative blasting level criteria for blasting activities.

**3.3.5.1** The maximum peak particle velocity (PPV) of ground vibration, at any of the monitoring locations, in any of the three mutually perpendicular components of particle velocity, for above-ground, residential structures shall be limited based upon the frequency of the blast vibration as shown in the following graph (Figure 4):

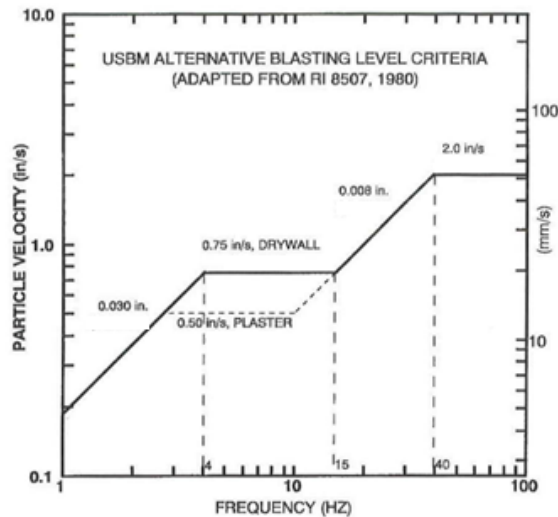

**FIGURE 4 - Particle Velocity vs. Frequency United States Bureau of Mines (RI8507, 1980)**

**3.3.5.2** The maximum PPV of ground vibrations, in any of the three mutually perpendicular components of particle velocity, for non-residential structures shall not exceed 2.0 in/s.

**3.3.5.3** The maximum PPV of ground vibrations, in any of the three mutually perpendicular components of particle velocity, for underground utilities shall not exceed 2.0 in/s. Buried pipelines and other utilities owned by private utility companies are sometimes subject to lower limiting values imposed by the owner. The Contractor shall verify the maximum allowable PPV of ground vibrations allowed by the individual utilities. If lower limits are required, a special provision describing the limits or conditions required will be included in the proposal. The Blasting Plan and blast design shall be modified accordingly to avoid damage to such utility lines.

**3.3.5.4** Deteriorated structures or utilities, structures housing computers or other sensitive equipment, and manufacturing processes that are sensitive to vibrations may require lower PPV limits than stated in this specification. If lower limits are required, a special provision describing the limits or conditions required will be included in the proposal.

**3.3.5.5** The Contractor shall not conduct blasting operations within 20 ft. of newly placed concrete (less than 14 days) without the written approval of the Engineer. For blasting greater than 20 ft. away from new concrete, the following PPV ground vibration limits apply:

<b>Ground Vibration Limits for New Concrete</b>	
Age of Concrete	Maximum PPV, in/s
Less than 3 days	No blasting
After 3 days	1.0 in/sec
After 5 days	1.8 in/sec
After 7 days	2.0 in/sec

**3.3.5.6** If blast induced ground vibrations exceed the limits for maximum PPV and modifications to the Blasting Plan cannot achieve vibration levels that fall within the specified limits, then alternative rock excavation techniques shall be required. All non-explosive methods of rock excavation are subject to approval by the Engineer.

**3.3.6 Air concussion.** The Contractor shall conduct all blasting activities in such a manner that the peak airblast overpressure at all above-ground, occupied structures in the vicinity of blasting does not exceed 134 dB. The air overpressures shall be recorded from each blast and shall be recorded as a linear, unweighted value.

### **3.3.7 Vibration monitoring instrumentation.**

All vibration monitoring instrumentation proposed for use on the project by the Contractor shall comply with the following requirements:

- (a) Measure, display, and provide a permanent record on a strip chart of particle velocity components.
- (b) Measure the three mutually perpendicular components of particle velocity in directions vertical, radial, and perpendicular to the vibration source and produce a real time graphical depiction of the particle velocities recorded for each individual axis for the duration of the event. Additionally, the seismograph(s) shall produce a numeric record of the peak particle velocities and principle frequencies of the vibration recorded for each axis during the event.
- (c) Have a velocity frequency response of 2 Hz to 150 Hz, and be capable of measuring PPV of up to 10 in/s.
- (d) All seismographs used on the project shall display the date of the most recent calibration.
- (e) Calibration must have been performed within the last 12 months and must be performed to a standard traceable to the National Institute of Standards and Technology.
- (f) All instruments and their use shall fully conform to standards published by the Vibration Section of the International Society of Explosive Engineers (ISEE). Seismograph sensors shall be placed so good contact with the ground is achieved and weighted down with sandbags if necessary.

**3.4 Unclassified excavation.** When the excavation is unclassified, either in the proposal or by the Contractor's bid, the Contractor may make arrangements with the Engineer for the taking of sufficient measurements of the rock in its original position to enable subsequent determination of the quantity of rock involved in any overbreakage. If the Contractor elects not to make such arrangements, the Contractor shall have no compensation for rock overbreakage.

**3.5 Muck Excavation.** Muck excavation shall be performed in areas shown on the plans and in areas encountered during the work where the material meets the definition of muck as defined in 2.4.

**3.5.1 Removal and replacement.** The excavation of muck shall be handled in a manner that does not permit the entrapment of muck within the backfill. The backfilling of the excavated area shall follow immediately behind the excavation of the muck in order that any soft material that is pushed ahead of the backfill can be removed. Backfill material shall follow the requirements of 3.6.1. Where groundwater is present the backfill material shall be placed in one continuous lift, to a maximum elevation of 4 ft. above the water level, unless otherwise directed. With muck removal, the Contractor shall allow the Engineer adequate opportunity to take all the necessary elevations and measurements for determining the volume removed.

**3.5.2** Any suitable muck removed shall be incorporated in portions of the embankment slopes as directed or used for other approved purposes.

### **3.6 Subgrade and Slopes.**

**3.6.1 Removal and replacement of unsuitable material.** Where excavation to designed elevations results in a subgrade or slopes of unsuitable material, the Engineer will require the removal of the unsuitable material to such limits as the Engineer may direct. The backfilling shall be done with approved embankment material conforming to 2.5 and compacted to the design subgrade or slope lines unless otherwise ordered. Material placed in subgrade or slopes with groundwater present shall be one of the following:

- (1) material meeting the requirements of 304.2;
- (2) rock, when rock is available from excavation; or
- (3) a mixture of both. Backfill replacing unsuitable material where groundwater is present shall follow immediately behind the excavation of unsuitable material in order that any unsuitable material that is pushed ahead of the backfill can be removed.

**3.6.2 Backfill of over-excavated subgrade in rock.** All over-excavated subgrade in rock shall be replaced with approved, porous, granular materials such as sand, gravel, broken rock, or any combination thereof. Non-porous materials will not be acceptable.

## SECTION 203

### 3.7 Embankments.

**3.7.1 General.** The Contractor shall place and compact embankment material in full uniform layers at thicknesses specified below or ordered. Continuous leveling and manipulation shall be employed to ensure uniform density. Where end dumping is employed, embankment material shall be dumped on the layer of embankment being constructed and bulldozed ahead into place. End dumping over completed work which allows material to roll into place will not be permitted.

**3.7.2 Backfill of holes.** Holes resulting from the removal of stumps, boulders, and the like, within the zone of anticipated frost action shall be filled and compacted with material similar to that surrounding the hole.

**3.7.3 Placing on steep slopes.** Benching or terracing of slopes steeper than 3:1 (horizontal to vertical) shall be performed in conjunction with the placing of embankments abutting such slopes, in the manner directed.

**3.7.4 Placing in unsuitable areas.** Removal and replacement of unsuitable material shall follow the requirements of 3.6.1.

**3.7.5 Placing rock on roadway.** Rock fragments in fills shall be placed in layers of such thickness as the Engineer may direct, and in no case in excess of 4 ft. The lifts shall be worked in such a manner as to close the voids with spalls and fines. When sufficient spalls or fines are not available to close the voids, earth shall be used to make a tight surface prior to placing the next lift.

**3.7.6 Placing embankment material at pile locations.** In areas where piling is to be driven, the embankment, unless otherwise permitted, shall be made and compacted before driving the piles. No rock fragments, boulders, or other solid material shall be placed where such material could interfere with pile driving operations.

#### 3.7.7 Placing Earth on Roadway.

**3.7.7.1** Earth shall be placed in layers the full width of the roadway, generally parallel to the finished grade. The layers shall not exceed 12" of loose depth unless otherwise directed. Each layer shall be spread to a uniform thickness and compacted to the required density prior to placing the next layer. Continuous grading or shaping shall be carried out concurrently with the compactive effort to ensure uniform density throughout each layer of material. Embankment material to be placed adjacent to granular backfill shall be placed concurrently with the granular backfill to provide lateral support.

**3.7.7.2** Embankments shall be graded at all times to ensure that water runs off the graded surface. Any saturation of non-porous material due to the Contractor's selected method of operation will require the suspension of additional work on the area until drying, removing and replacing, or draining has restored the fill to a stable condition at the Contractor's expense.

**3.7.8 Winter construction methods.** No embankments shall be constructed on frozen earth materials. Each layer of material placed shall be compacted to the required density before it freezes. All frozen material shall be removed from the top of embankments prior to placing additional material. The frozen lumps of earth removed shall be placed outside of the limits of an assumed 1.5:1 (horizontal to vertical) slope from the break in the shoulder and inside the designed or ordered slope line. If the above specified conditions cannot be met, earthwork operations shall be suspended. In no case shall the scarifying or breaking up of frost be accepted instead of removal.

**3.7.9 Backfill at structures.** Backfill at structures shall conform to 504.3.4.3.

**3.7.10 Embankment Foundation.** Unless otherwise shown on the Plans or ordered, where the existing ground is 3 ft. or less below subgrade, the top 6" within the limits of the roadbed shall be compacted to the same density as that required of the first layer of material to be placed over it.

### 3.8 Density Requirements and Tests.

**3.8.1** For earth materials under approach slabs and for earth materials within 10 ft. of the back of structures not having approach slabs, at least 98 percent of maximum density shall be obtained. For all other earth materials at least 95 percent of maximum density shall be obtained. The maximum density determination shall be made as specified in AASHTO T 99 (Standard Proctor Test). The in-place density determination shall be made by AASHTO T 191 (Sand-Cone Method) or by AASHTO T 310 (Nuclear Methods). If the required density cannot be achieved with the equipment at hand, the Contractor shall obtain whatever equipment is necessary to achieve the specified density. Manipulation of tills, silts, and clays, or any combination thereof, (including aeration where necessary) will be required to produce a stable fill of the required density.

**3.8.2** Those materials that cannot be tested for maximum density in accordance with AASHTO T 99 may be tested for maximum density by the following procedure:

**3.8.2.1 Test Strip Procedure.** At the beginning of the compaction operation, the maximum density shall be determined by compacting a short control section or "test strip" at a suitable moisture content until no further increase in density can be obtained. The densities shall be obtained by the use of nuclear density testing equipment. A new test strip may be required by the Engineer



where there is a significant change in the gradation of material being placed. Compacting of the test strip shall be done with an approved vibratory roller or compactor producing a dynamic force of at least 27,000 lb.

### 3.9 Disposal of Surplus and Waste Material.

#### 3.9.1 Definitions.

- (a) Surplus material. Excess material from excavation beyond the minimum requirements of the project but otherwise suitable for use.
- (b) Waste material. Material unsuitable for use in the work except in noncritical areas.

#### 3.9.2 Blank.

**3.9.3** When practicable and wherever directed, surplus and waste material shall be used for flattening slopes or for other grading within the project.

**3.9.4** When specified as embankment-in-place surplus or stockpile surplus, the material shall be placed as shown on the plans or as directed in the Proposal in accordance with the appropriate specification.

**3.9.5** In case it is impossible to dispose of all the surplus and waste material in the manner described above, it shall be the Contractor's responsibility to secure disposal areas for approval and to dispose of all surplus and unsuitable material as part of the excavation items if such areas are not shown on the Plans.

**3.9.6** If disposal of surplus and waste material is by burying, the cover material shall be graded and shaped as directed by the Engineer. If material is to be placed on private land, the agreements as to how the disposal area is to be left shall be set forth on the Disposal Agreement form provided by the Department in accordance with 106.10. Three signed copies of the Disposal Agreement shall be furnished to the Engineer. Approval of the proposed disposal area will be contingent upon agreement by the Contractor and the property owner to leave the area in such shape that it blends with the surrounding terrain and that erosion is kept to a minimum. Without special permission, slopes shall not be left steeper than 2:1 (horizontal to vertical). No disposal area shall be left in such condition that erosion might result in water pollution by silt or other deleterious substances. Areas shall be left in such shape and condition that material does not wash and block or obstruct drainage ways. If holes caused by settlement appear, they shall be filled as directed. A release from the property owner is required prior to Project Acceptance.

**3.9.7** Unless otherwise ordered, disposal areas shall be covered with material capable of supporting vegetation and either fertilized and seeded with grass seed or planted with seedlings. Seedlings shall be set out in accordance with accepted horticultural practices as directed in the agreement.

**3.9.8** Unless permission is given to preserve access roads to disposal areas adjacent to highways, such access roads shall be obliterated.

**3.9.9** When the Contract requires the removal of existing pavement but does not require recycling, the Contractor is encouraged to save this bituminous material for future reuse. This material is considered to be a valuable resource because of the residual asphalt contained in it. Therefore, no existing bituminous pavement removed shall be incorporated in the embankment. If the Contractor elects to dispose of bituminous material it shall be disposed of in accordance with the Department of Environmental Services Waste Management Division regulations at no expense to the State.

#### 3.10 Blank.

#### 3.11 Embankment-in-place.

**3.11.1** When the embankment is constructed under this item, all construction requirements herein shall apply. Slopes excavated beyond the template lines without authorization shall be refilled when ordered, at no expense to the Department.

**3.11.2 Sources.** Unless otherwise designated in the Contract, the Contractor shall make arrangements for obtaining material for embankment-in-place (See 106.02). Permission to remove material beyond the template lines within the right-of-way and adjacent thereto shall be approved in writing before any material is removed and will be contingent on many factors and if permission is granted, it will be by the Engineer after review by all interested parties. Permission may be contingent, among other considerations, upon agreement by the Contractor to leave regular and uniform slopes in the area. Slopes excavated beyond the template lines without authorization shall be refilled when ordered, at no expense to the State. When permission to remove material beyond template lines within the right-of-way is granted, the cubic yard price will be contingent upon material type and agreed upon prior to authorization.

**3.12** Manipulation of the soil, as specified in 203.3.8.1, shall be required before compaction when the material's moisture content is beyond the limits specified above.

## SECTION 203

### 3.13 Platforms.

**13.1.1** Guardrail terminal units, tapered rail, MELT, ELT, E-2 and portable changeable message sign platforms shall be constructed as shown on the plans with the top layer of the platforms constructed of 6" of crushed gravel for shoulder leveling.

**3.13.2 SWZ Device Platforms.** SWZ device platforms shall be installed as shown on the plans with the top layer of the platform constructed with 6" of crushed gravel for shoulder leveling.

**3.13.2.1** SWZ platforms shall be removed when the platform is no longer needed or as directed by the Engineer. The disturbed area shall be graded to its existing condition and acceptable to the Engineer. Disposal of surplus material removed shall become the responsibility of the Contractor as set for in [203.3](#).

**3.13.3 Offset Platforms.** Offset platforms shall be installed as shown on the plans.

**3.13.4** Crushed gravel for shoulder leveling and gravel if required shall be placed in accordance with [304.3](#).

#### Method of Measurement

**4.1.** Excavation, embankment-in-place, embankment-in-place surplus, stockpile surplus, rehandling surcharge material may be measured by the cubic yard in accordance with [109.01](#).

**4.1.1** When the Contractor is directed to excavate beyond the template lines shown, the material removed will be measured under the appropriate excavation item.

**4.1.2** When the Contractor is given permission to excavate beyond the template lines shown within the right-of-way, the material will be measured by the cubic yard in accordance with [109.01](#). Material removed from outside of template lines without prior approval will be quantified and deducted from the Contract.

**4.1.3** Embankment-in-place surplus and uncompacted stockpile surplus will be measured by the cubic yard after placement.

**4.2** No measurements of any pits will be made for the purpose of establishing pay quantities for any Contract Item. Any and all measurements or cross-sectioning of pits used in conjunction with the work will be made for informational purposes only. Embankment-in-place will not be measured, but shall be the cubic yard final pay quantity in accordance with [109.11](#) for compacted material required within template lines as shown on the plans. No deductions will be made from the template quantities unless otherwise specified.

**4.2.1** If the actual topsoil removal, or the actual unsuitable material excavation, or the actual muck excavation beneath embankment areas differs from the estimated quantity shown on the Plans and backfill, an adjustment will be made to the final pay quantity of embankment-in-place equal to the actual increase or decrease from the estimated quantity for the material excavated.

**4.4** When the Contract does not specifically provide for payment for embankment-in-place, the work of embankment construction will not be measured as such but will be considered incidental to the various classifications of earthwork.

**4.5** Surcharges will be sectioned in place immediately prior to removal, and the designed or revised subgrade template will be used as the final section.

**4.6** Where presplitting is required, rock excavation will be measured only to the slope and depth lines shown on the plans or as ordered.

**4.7** Presplitting holes and extra drilled holes without explosives will be measured by the linear foot, measured from the top of the drill hole at the rock surface to the bottom of the hole or to the elevation of the required subgrade (whichever is higher) or to an established bench elevation. Portions of holes not meeting the requirements as set forth in 3.3.5 or 3.3.9 will not be measured. Presplitting holes and extra drilled holes without explosives drilled where presplitting is not required by these specifications will not be measured.

**4.8** Where presplitting is not required, actual overbreakage of rock in the slopes will be measured and allowed to a maximum of 24 in, measured horizontally, beyond the required slope lines where adequate cross-sections have been taken of the original rock in accordance with the provisions of 3.2.1 and 3.4. No allowance for overbreakage will be made below the subgrade elevation. Only overbreakage rock that is actually excavated will be measured for payment.

**4.9** Where the Engineer determines that the removal of additional rock is necessary due to conditions clearly not attributable to the Contractor's methods of operations, the payment lines will be adjusted to the limits ordered, to include only rock actually removed within such limits.

**4.10** Guardrail MELT, guardrail ELT, offset EAGRT and portable changeable message sign platforms will be measured as a unit. The unit shall include excavation, embankment, gravel (if required), and crushed gravel for shoulder leveling.

**4.11** Guardrail E-2 and guardrail tapered rail platforms will be measured by the linear foot. The linear foot price shall include excavation, embankment, gravel (if required), and crushed gravel for shoulder leveling.

**4.12** Installation and removal of SWZ device platforms will be measured as a unit. The unit shall include excavation, embankment, gravel (if required), crushed gravel for shoulder leveling, removal of material placed, disposal of surplus material and grading of disturbed area.

### **Basis of Payment**

**5.1** The accepted quantities of excavation and embankment, of the type specified, will be paid for at the Item Bid Price per cubic yard for each of the pay items listed below that is included in the Contract, with the following stipulations:

**5.1.1** Embankment-in-place is a final pay quantity and will be paid for at the Contract unit price per cubic yard, in accordance with 109.11, with appropriate deductions for embankment slopes shown to be below prescribed template lines.

**5.1.2** When surcharges are required, that portion of the surcharge ordered removed will be paid for as rehandling surcharge material.

**5.1.3** Excavation of unstable materials in the slopes of roadway cuts will be paid for as provided in 585.5.4. Backfill of such slopes shall be with material meeting the requirements of either 209.2.1.3, 585 or approved ledge, as determined by the Engineer. Payment will be made under items 209.1 or 585 unless otherwise shown on plans.

**5.1.4** Topsoil removal will be paid for as common excavation except when overlying muck excavation, in which case such topsoil removal will be paid for as muck excavation. Payment of excavation will be full payment for excavating, transporting and stockpiling topsoil at approved locations.

**5.1.5** Roadside ditches adjoining excavated areas will be paid for as common, rock, or unclassified excavation, as appropriate, unless such ditches are shown on the plans or ordered to be paid for under another item.

**5.1.6** When conflicting pay lines for more than one type of excavation exist in an area, payment will be made to the limits of each type of excavation in the following order of priority unless otherwise indicated on the plans:

- (1) Common, Rock, Muck, or Unclassified Excavation
- (2) Channel Excavation
- (3) Structure Excavation
- (4) Bridge Excavation

**5.1.7** Concrete class F, flowable fill substituted for embankment will be paid for at the Contract unit price for the item substituted.

**5.1.8** Excavation of unsuitable material beneath embankment areas or at subgrade will be paid for as common excavation, unless material is classified as rock, muck, structure or other excavation item. When the excavation is classified the payment for underlying unsuitable material will be made under the classified item.

**5.1.9** Gravel backfill material as specified in 3.6.1 (1), or (3) used to backfill unsuitable material excavation or muck excavation beneath embankment areas or at subgrade will be paid for under 304.2 with no adjustment in the embankment-in-place final pay quantity. Rock backfill as specified in 3.6.1 (2) or (3) will be paid as Item 203.6 with an adjustment in the embankment-in-place final pay quantity as provided in 203.4.2.1. Materials meeting the requirements of 3.6.1 (1), (2), or (3), used to backfill unsuitable materials in the slopes of roadway cuts will be paid as provided in 5.1.3 with no adjustment in the embankment-in-place final pay quantity.

**5.2** No payment will be made for materials used to shim unauthorized over-excavated areas back to designed slope lines and subgrade, or for materials placed outside of designed or ordered slope lines.

**5.2.1** A penalty of five times the Contract unit price of the type of material removed will be deducted from money due the Contractor for the quantity of material removed from outside the template lines without authorization.

**5.3** No payment will be made under the item of embankment-in-place for materials used to backfill holes left by the authorized removal of stumps, boulders, and the like.

**5.4** No separate payment will be made for aeration or compaction equipment or methods of operation.

**5.5** Except for any Extra Work that may be ordered, embankment-in-place will include all work required in connection with pits.

**5.6** When common excavation is the only class included in the Contract, any rock encountered will be paid for at a price equal to five times the unit price for common excavation under Item 203.2.

## SECTION 203

**5.7** When no item for muck excavation is contained in the Contract, muck encountered and verified as meeting that definition will be paid for at 1.5 times the Contract unit price for common excavation as contained in the Contract or negotiated by change order when no common excavation item is contained in the Contract.

**5.8** Benching or terracing performed under 3.7.3 will be subsidiary, except that rock removed as ordered will be paid for under Item 203.2.

**5.9** The accepted quantity of presplitting holes or extra drilled holes without explosives will be paid for at the Contract unit price per linear foot, complete as specified, except that when no item for presplitting holes is included in the Contract, such work will be subsidiary.

**5.10** All costs incurred by the Contractor in preparing an approved blasting plan, in maintaining a blasting log, and in adopting revised blasting methods necessary to produce an acceptable test shot shall be considered incidental to the Contract unit prices for rock excavation and presplit blasting.

**5.11** The cost of all blast vibration control and monitoring, pre-blast condition surveys, post-blast surveys, blasting precautions, the use of borehole deviation equipment to measure the orientation of presplit hole, and other protective measures necessary to prevent damage and the subsequent creation of claims in connection with blasting shall be included under Item 203.2.

**5.12** The accepted quantity of guardrail terminal unit platform MELT, ELT, SWZ platforms and offset platforms for EAGRT will be paid for at the Item Bid Price per unit complete in place.

**5.12.1** Removal of SWZ platforms shall be removed when the platform is no longer needed or as directed by the Engineer. The disturbed area shall be graded to its existing condition and acceptable to the Engineer. Disposal of surplus material removed shall become the responsibility of the Contractor as set for in 203.3.

**5.13** The accepted quantity of guardrail terminal unit platform for E-2 and tapered rail will be paid for at the Item Bid Price per linear foot, complete in place.

### Pay items and units:

203.1	Common Excavation	Cubic Yard
203.2	Rock Excavation	Cubic Yard
203.3	Unclassified Excavation	Cubic Yard
203.4	Muck Excavation	Cubic Yard
203.5525	Portable Changeable Message Sign Platform	Unit
203.5540	Guardrail Tapered Rail Platform	Linear Foot
203.55542	Guardrail EAGRT Offset Platform Alternate, TL-3	Unit
203.55543	Guardrail EAGRT Offset Platform, TL-3	Unit
203.5551	Guardrail MELT Platform	Unit
203.5552	Guardrail ELT Platform	Unit
203.55552	Guardrail EAGRT Offset Platform Alternate, TL-2	Unit
203.55553	Guardrail EAGRT Offset Platform, TL-2	Unit
203.55261	Installation and Removal of SWZ – Portable Queue Trailer Platform	Unit
203.55262	Installation and Removal of SWZ – Portable Changeable Message Sign Platform	Unit
203.55264	Installation and Removal of SWZ – Mobile Video Trailer Platform	Unit
203.5596	Guardrail E-2 Platform	Linear Foot
203.6	Embankment-in-Place (F)	Cubic Yard
203.7	Rehandling Surcharge Material	Cubic Yard
203.61	Embankment-in-Place Surplus	Cubic Yard
203.65	Stockpile Surplus	Cubic Yard
203.81	Presplitting Holes	Linear Foot
203.82	Extra Drilled Holes Without Explosives	Linear Foot

**SECTION 206 -- STRUCTURE EXCAVATION  
FOR PIPES AND OTHER MINOR STRUCTURES**

**Description**

**1.1** This work shall consist of the excavation and backfill or disposal when necessary of all materials required to be removed to complete the work as shown on the plans or as ordered. Excavation for the following shall be included under this item: berm ditches, inlet ditches and outlet ditches, sand drains, drainage pipes, multiple pipe structures, manholes, catch basins, drop inlets, cattle passes, headwalls, overhead traffic sign bases and the like, water and sewer pipes, pipe sleeves, conduits, and channels with less than a 10 ft-bottom width. Excavation for roadway ditches not adjoining roadway excavation will be included in this item unless otherwise specified.

**Classification of Materials**

**2.1** Common structure excavation shall consist of all excavation described above that is not classified as rock structure excavation. Glacial till or boulder clay will be considered as common structure excavation.

**2.2** Rock structure excavation shall consist of all solid rock that can be removed only by blasting or ripping. It shall also consist of boulders and parts of masonry structures when found to measure 1 cy or more, except as provided in 604.5.2.2.

**2.3** Unclassified structure excavation shall consist of all structure excavation encountered.

**Construction Requirements**

**3.1** All excavation shall be removed to the limits shown or ordered and the excavated material incorporated in the work or disposed of as directed. Berm ditches shall be constructed at the top of cut slopes as shown on the plans or as ordered.

**3.2** Excavated areas, including unsuitable material, below structures and pipes in rock shall be removed to the limits specified and backfilled to the bottom of the pipe or structure with approved material. (See also 603.3.1.)

**3.3** Excessive widths of trench in excavation for pipes will not be permitted. Below the level of the tops of the pipes, the walls of trenches shall be kept as nearly vertical as practicable. Trenches shall be shored in accordance with OSHA Regulations. (See also 603.3.1.7.)

**3.4** When blasting is required, the provisions of 203.3.2 shall apply as though contained in this Section.

**Method of Measurement**

**4.1** Structure excavation will be measured by the cubic yard in accordance with 109.01.

**4.1.1** The lower limits shall be as shown on the plans, as designated in Figure 1 in 603, or as provided below. The upper limits shall be the original ground except as provided in 203.5.1.6. All excavation for pipes and other structures that are to be installed by others will be measured for payment; otherwise, the first 9 ft. of common structure excavation for pipes, manholes, catch basins, and drop inlets even when ordered in addition to those shown on the plans, shall be subsidiary except as follows:

(a) The depth of unsuitable material removed as directed below grade will be measured for payment. In case the width ordered is wider than the specified payment limits in 4.1.2, the extra excavation will be measured in accordance with Figure 1-D of 603.

(b) When excavation is required more than 1 ft. deeper than the excavation shown on the plans, the depth of excavation below the 1 ft. limit will be measured for payment.

**4.1.2** Unless otherwise shown on the plans, the horizontal limits shall be as follows for pipes:

<b>Inside Diameter</b>	<b>Total Width</b>
Up to 12"	36"
12 to 24"	I.D. + 24"
Over 24"	2 x I.D.

**4.1.3** The horizontal limits for end sections shall be the same as the pipes to which they are attached.

**4.1.4** The horizontal limits for structures such as manholes, catch basins, headwalls, and the like will be 1 ft. outside of the base of the masonry and parallel or concentric thereto.

**4.2** All material classified as rock encountered within the neat lines established under this Section will be measured. No payment will be made for any overbreakage below or beyond the limits specified.

**4.3** In case a conflict of horizontal limits exists in payment lines, as where a pipe enters a headwall, the greater limit will be used for computing the quantity.

## SECTION 206

4.4 Unclassified structure excavation for exploratory purposes will be measured as provided under the applicable provisions of 206.4.1.

### Basis of Payment

5.1 The accepted quantity of structure excavation will be paid for at the Contract unit price per cubic yard complete in place.

5.2 Granular material specified or ordered will be paid for under [Section 209](#).

5.3 When common structure excavation is the only class included in the Contract, any rock encountered will be paid for at a price equal to five times the unit price for common structure excavation under Item 206.2.

5.4 When structure excavation items are included in the Contract, but no items for exploratory purposes are in the Contract, payment for excavation made for investigations or exploratory purposes will be paid for under Item 206.19 at five times the unit price for the class of excavation encountered.

5.5 If neither Item 206.1 nor Item 206.2 nor an item for exploratory purposes is included in the Contract, any structure excavation encountered, including excavation for investigation or exploratory purposes, will be paid in accordance with [109.04](#).

5.6 No separate payment will be made for pre-blast and post-blast surveys or blasting monitoring work.

### Pay items and units:

206.1	Common Structure Excavation	Cubic Yard
206.19	Common Structure Excavation – Exploratory	Cubic Yard
206.2	Rock Structure Excavation	Cubic Yard
206.39	Unclassified Structure Excavation – Exploratory	Cubic Yard

**SECTION 207 -- CHANNEL EXCAVATION****Description**

**1.1** This item shall consist of the excavation and disposal of all materials encountered in the construction of channels having a bottom width of 10 ft. or more, except inlet and outlet ditches for multiple pipe culverts, as shown on the plans or as ordered.

**Classification of Materials**

**2.1** Common channel excavation shall consist of all excavation described above that is not classified as rock channel excavation. Glacial till or boulder clay will be considered as common channel excavation.

**2.2** Rock channel excavation shall consist of all solid rock that can be removed only by blasting or ripping. It shall also consist of boulders and parts of masonry structures when found to measure 1 cy or more.

**2.3** Unclassified channel excavation shall consist of all the channel excavation encountered.

**Construction Requirements**

**3.1** Channel excavation shall be removed to the limits shown or ordered.

**3.1.1** When blasting is required, the provisions of 203.3.2 shall apply as though contained in this Section.

**3.2** All surplus material shall be incorporated in the work or disposed of as directed.

**3.3** No excavation shall be performed prior to cross-sectioning.

**Method of Measurement**

**4.1** Channel excavation will be measured by the cubic yard in accordance with 109.01. The upper limit shall be original ground except as provided in 203.5.1.6. No allowance will be made for material excavated before measurements have been made or for material excavated beyond the required slope lines.

**4.2** Blast vibration control and monitoring, preblast condition surveys, postblast surveys, blasting precautions and other protective measures will not be measured.

**Basis of Payment**

**5.1** Channel excavation will be paid for at the Contract unit price per cubic yard complete for each class of channel excavation included in the Contract. When common channel excavation is the only class included in the Contract, any rock encountered will be paid for at a price equal to five times the Contract unit price for common channel excavation under Item 207.2.

**5.2** The cost of all blast vibration control and monitoring, preblast condition surveys, postblast surveys, blasting precautions and other protective measures necessary to prevent damage and subsequent creation of claims in connection with blasting shall be subsidiary to Item 207.2 or Item 207.3.

**Pay items and units:**

207.1	Common Channel Excavation	Cubic Yard
207.2	Rock Channel Excavation	Cubic Yard
207.3	Unclassified Channel Excavation	Cubic Yard

## SECTION 209

### **SECTION 209 -- GRANULAR BACKFILL**

#### **Description**

**1.1** This work shall consist of furnishing and placing porous granular material at the locations shown on the plans or ordered.

#### **Materials**

**2.1** The material shall consist of stones, rock fragments, and fine hard durable particles resulting from the natural disintegration of rock. The material shall be free from harmful amounts of organic matter. The wear shall not exceed 60 percent. No more than 12 percent of the material passing the No. 4 sieve shall pass the No. 200 sieve, and the material shall conform to the following gradations:

**2.1.1** Granular backfill (sand) shall consist primarily of particles with 100 percent passing the 3" sieve and 70 to 100 percent passing the No. 4 sieve.

**2.1.2** Granular backfill (gravel) shall consist of a mixture of stones or rock fragments and particles with 95 to 100 percent passing the 3" sieve and 25 to 70 percent passing the No. 4 sieve.

**2.1.3 Granular Backfill (Bridge).** When this item is specified the material shall meet the gradation requirements of Item 304.2.

**2.1.4 Granular Backfill.** When this item is specified, the gradation shall conform to 2.1.1 or 2.1.2.

**2.2** Concrete class F, flowable fill may be requested in writing as a substitute for granular backfill. Approval shall be in consideration of, but not limited to, differential frost heaving due to dissimilar materials, unit weight, structural requirements, lack of permeability, and damming resulting from water flow cut off.

#### **Construction Requirements**

**3.1** Granular backfill of the specified or ordered gradation shall be placed in layers at the locations shown or ordered. Backfill shall be placed in the manner detailed in the appropriate section in which the backfill is specified. The backfill layers shall not exceed 8" of compacted depth unless otherwise directed. Density shall meet the requirements of [203.3.8](#).

#### **Method of Measurement**

**4.1** Granular backfill will be measured by the cubic yard in accordance with [109.01](#). When granular backfill is specified as included in another item, no separate measurement will be made for the backfill furnished in connection with that item.

**4.2** Backfill of over-excavated areas beyond or below the lines and grades shown or ordered will not be measured for payment.

**4.3** For pipe having an inside diameter of less than 48" no deduction will be made from granular backfill of the volume occupied by the pipe constructed under 603 when granular backfill is ordered as bedding material.

**4.4** Granular backfill (bridge) will not be measured, but shall be the cubic yard final pay quantity in accordance with [109.11](#) for compacted material required within the limits shown on the plans.

#### **Basis of Payment**

**5.1** The accepted quantity of granular backfill, of the type specified, will be paid for at the Contract unit price per cubic yard complete in place.

**5.2** Granular backfill (bridge) is a final pay quantity item and will be paid for at the Contract unit price per cubic yard complete in place in accordance with [109.11](#).

**5.3** Concrete class F, flowable fill substituted for granular backfill will be paid for at the Contract unit price for granular backfill of the type specified.

#### **Pay items and units:**

209.1	Granular Backfill	Cubic Yard
209.20X	Granular Backfill (Bridge) (F)	Cubic Yard
209.3	Granular Backfill (Sand)	Cubic Yard
209.4	Granular Backfill (Gravel)	Cubic Yard



**SECTION 211 -- VIBRATION MONITORING****Description**

**1.1** This work shall consist of monitoring construction related vibrations and setting vibration limits to avoid damaging existing nearby structures, properties and utilities located on or near this project.

**1.1.1** Sources of construction related vibrations which are covered by this specification include compaction equipment (sections 203, 209, 304, 508), cofferdam construction (section 503), sheet piling (section 506) and bearing piles (section 510) or other construction activities as identified. The provisions of section 203.3 shall still apply to vibrations caused by blasting operations.

**1.2** The work under this specification includes providing the services of a qualified Vibration Consultant.

**1.2.1** As part of this work, the Vibration Consultant shall submit vibration documentation as described in 211.3.7.

**Construction Requirements**

**3.1 Vibration Consultant Qualifications.** The Vibration Consultant shall meet all the applicable qualification requirements of 203.3.3.1 and 203.3.3.2. The same Vibration Consultant shall be used on all monitoring activities throughout the project.

**3.2 Vibration Monitoring Plan.** Prior to initiating a particular activity which requires vibration monitoring, the Contractor shall submit a Vibration Monitoring Plan prepared by the Vibration Consultant. The plan shall be submitted a minimum of 10 working days prior to beginning the particular construction activity. The construction activity shall not begin until the plan has been approved, except as allowed under 3.2.1.

**3.2.1** Prior to the production phase of the particular construction activity, the Contractor will be permitted to conduct a test program to establish the allowable vibration limits, subject to approval. The production phase shall not begin until the results of the test program have been approved.

**3.2.2** The plan shall include the following:

- a) The qualifications of the Vibration Consultant in accordance with 3.1.
- b) A description of the monitoring equipment in accordance with 3.3.
- c) Recommendations for vibration limits for the particular construction activity under consideration, or recommendations for a test program in accordance with 3.2.1, if the vibration limits cannot be predetermined. Justification shall be provided for all recommendations.
- d) Recommendations for structures, utilities and all other facilities which in the judgment of the Vibration Consultant require a pre and post construction condition survey in accordance with 3.4. This recommendation shall pay particular attention to historic structures, structures in poor condition, structures supported by vibration sensitive materials which could cause settlement or loss of support, and structures which contain sensitive equipment or processes. The Monitoring Plan shall also include methods for measuring deformation or settlement of selected structures, if deemed necessary by the Vibration Consultant or Engineer.
- e) Recommendations, if it is determined that the proposed construction activity could not be reasonably implemented without exceeding vibration limits that are necessary to protect adjacent facilities.

**3.2.3** As part of the review of the Monitoring Plan, the Engineer may require modifications to the submittal to include, but not limited to, surveying and monitoring of additional structures, the number of monitoring sites and the distances for monitoring. There may be a need for simultaneous setups with multiple monitoring devices.

**3.3 Vibration Monitoring Instrumentation.** All vibration monitoring equipment shall meet the requirements of 203.3.3.7.

**3.4 Pre and post construction condition surveys.** The Contractor shall conduct a pre-construction condition survey on all structures, including swimming pools and mobile homes, within 150 feet of the anticipated sources of construction related vibrations. A pre-construction survey shall also be conducted on structures that may be affected by construction related vibrations beyond the 150 foot distance as directed by the Engineer or as contained in the approved Vibration Monitoring Plan. The pre-construction surveys shall not be initiated until the Vibration Monitoring Plan has been approved. Upon completion of all construction operations that are a source of construction related vibrations, the Contractor shall conduct a post-construction condition survey of any structure for which a complaint of damage has been received or a damage claim has been filed. Notification of the post-construction survey shall be given to all interested parties, so they may be present during the survey. A copy of the pre-construction condition surveys shall be provided to the Engineer prior to the start of work. A copy of any post-construction condition survey conducted shall be provided to the Engineer upon its completion.

**3.5 Coordination Meeting.** A coordination meeting arranged by the Contractor shall be held prior to initiating the particular construction activity and the associated vibration monitoring. The coordination meeting shall not take place until the Contractor has submitted and received approval of the Vibration Monitoring Plan. The purpose of the meeting shall be to review all aspects

## SECTION 211

of the vibration monitoring and to facilitate coordination between all parties involved. Individuals attending the meeting shall include the Engineer, the Vibration Consultant, the Contractor, the Sub-Contractor involved with the particular construction activity, the Research Geologist from the Materials and Research Bureau and all other personnel deemed appropriate by the previously mentioned personnel. The Engineer and Research Geologist shall be notified at least 5 working days in advance of the meeting.

**3.6 Schedule for Vibration Monitoring.** The frequency and duration of vibration monitoring for a particular construction activity shall be as directed by the Engineer. The Contractor shall make all necessary arrangements for scheduling the Vibration Consultant, after direction to provide vibration monitoring has been given. The particular construction activity requiring monitoring shall not begin until the Vibration Consultant is on-site.

**3.7 Vibration Monitoring Reports.** At the end of each day of monitoring, the following information shall be recorded and submitted to the Engineer:

- a) The name of the Contractor and/or Subcontractors responsible for the particular construction activity.
- b) The name and signature of the approved Vibration Consultant.
- c) The name of the operator of the vibration monitoring equipment.
- d) A sketch indicating the location of the vibration monitors and the particular construction activity.
- e) Complete details of the particular construction activity which is being monitored, including all related equipment, operating frequencies, piling depths and all other related information as requested by the Engineer.
- f) Results of monitored vibrations and noise levels for the particular construction activity. The information should include the frequencies of the measured peak particle velocities.
- g) Identification of any activity that caused the vibration limits to be exceeded and the time of day that the limits were exceeded.
- h) A summary of any vibration related complaints received during the day.

**3.7.1** The Vibration Consultant shall complete and submit the Contractor Vibration Report Form for each vibration producing activity each day. Submission of the daily reports at the conclusion of each vibration producing activity is acceptable. The required form can be found at the [Department's Website](#). Submit two (2) copies; one to the Engineer and one copy to:

New Hampshire Department of Transportation  
Attention: Research Geologist  
5 Hazen Drive, PO Box 483  
Concord, NH 03302-0483

**3.8 Adjustments in construction procedures.** All complaints about vibrations shall be reported immediately to the Engineer. If the monitoring data indicates that the ground vibration limits for any of the three mutually perpendicular components have been exceeded, the Contractor shall cease the particular construction activity and submit a written report giving corrective action. The construction activity shall not resume until the report has been reviewed and approved by the Engineer. If complaints occur when vibrations are below the specified limits, the Engineer may order the Contractor to modify the operations to reduce the vibrations further.

### Method of Measurement

**4.1** Vibration monitoring services including pre and post construction surveys will be measured by the hour for the accountable time on site to the nearest one-quarter hour. The hourly rate is all inclusive of the equipment and personnel necessary to perform the vibration monitoring service. The hourly rate is also all inclusive of equipment and personnel necessary to measure or monitor for potential deformation in structures.

**4.1.1** Travel time and other time not spent at the construction site and time not authorized will not be measured.

### Basis of Payment

**5.1** The accepted quantity of vibration monitoring services will be paid for at the Contract unit price per hour, complete. A minimum of 4 hours will be paid for each day's service.

**5.1.1** The Vibration Monitoring Plan will be subsidiary except that payment will be made for time on-site which is used in conducting a test program in accordance with 3.2.1.

**5.1.2** Travel time and other time not spent at the construction site or off-site areas and support services (i.e., travel, mileage, clerical staff, miscellaneous expenses, overhead, etc.) will be subsidiary.

**5.1.3** No payment will be made for time spent in preparing the reports for the condition surveys.

### Pay Item and Unit:

211.11	Vibration Monitoring Services	Hours
--------	-------------------------------	-------

**SECTION 214 -- FINE GRADING****Description**

**1.1** This work shall consist of the final grading necessary to make the subgrade, the area under the surface course, the roadway outside the surface course, and other locations as directed by the Engineer conform to the lines shown on the plans or established by the Engineer.

**Construction Requirements**

**3.1** The surface of each course of material shall be fine graded to conform to the typical section of the plans prior to placing the succeeding course. Each course shall be fine graded to conform to the lines and grades as shown on the plans. When fine grading to a specific slope prior to paving, the slope tolerance will be  $\pm 0.2\%$ .

**3.1.1** Cross slope to be measured by the following method: Measurements will be taken by placing a 10-foot metal straight edge on the surface perpendicular to the traveled lane. A 4-foot direct reading level shall be placed on top of it. Percent cross slope shall be read and recorded. A second reading 180 degrees to the first shall be taken and recorded and the two shall be averaged for the test result.

**3.1.2** The use of automated grade and slope control will be required on all graders.

**3.1.3** On projects or parts of projects where the Engineer deems that the use of automatic controls are impracticable, some or all of the controls in 3.1.2 may be waived.

**3.2** Shoulders, slopes, and ditches shall be shaped with suitable machinery supplemented by hand labor to reasonably smooth surfaces that are in keeping with the character of the adjacent terrain and shall merge into the adjacent terrain without any noticeable break. Culverts and waterways shall be cleared of all obstructions. Rubbish, brush, loose rock, boulders, and all other debris from the construction work shall be removed and disposed of as directed.

**3.3** To be acceptable under this item, the entire roadway must present a uniformly finished appearance at the completion of the work.

**3.3.1** The Contractor shall give 24 hour notice of the expected completion of the final fine grading prior to paving, to allow inspection by the Engineer.

**Method of Measurement**

**4.1** Fine grading, except as specified in 4.2, will be measured as a unit. If the project is altered to require substantial changes in the length, width, or character of the fine grading from such length, width, or character shown on the plans, the Contract Unit price will be subject to a negotiated revision.

**4.2** Fine grading of earth berms constructed in rock cuts will be measured by the linear foot to the nearest 1-foot along the adjacent ditch line.

**Basis of Payment**

**5.1** The accepted quantities will be paid for at the Contract Unit price for fine grading not otherwise classified and per linear foot for fine grading earth berms constructed in rock cuts.

**5.2** When no quantity for this item is included in the Contract, this work will be subsidiary.

**Pay items and units:**

214.	Fine Grading	Unit
214.3	Fine Grading Earth Berms in Rock Cuts	Linear Foot



## DIVISION 300 -- BASE COURSES

### SECTION 304 -- AGGREGATE BASE COURSE

#### Description

**1.1** This work shall consist of furnishing and placing base courses on a previously prepared subgrade or course as shown on the plans or as ordered.

**1.2** This work shall also include raising the grade of the edge of the roadway shoulders with crushed aggregate as shown on the plans or as ordered to match the grade of the pavement course placed on the shoulders or to provide a base for shoulder pavement.

#### Materials

##### 2.1 General.

**2.1.1** The materials shall consist of hard, durable particles or fragments of stone or gravel. Materials that break up when alternately frozen and thawed or wetted and dried shall not be used for aggregate base course materials. Fine particles shall consist of natural or processed sand. The materials shall be free of harmful amounts of organic material. Unless otherwise specified, the percent wear of base course material shall not exceed 50 percent as determined by AASHTO T 96, Grading A.

**2.1.2** Crushed stone shall be processed material obtained from a source that has been stripped of all overburden. The processed material shall consist of clean, durable fragments of ledge rock of uniform quality and reasonably free of thin or elongated pieces.

**2.1.3** Materials for glass cullet shall either be separated/recyclables received from a recycling facility permitted (pursuant to RSA 149-M:10) by the Waste Management Division of the Department of Environmental Services and/or materials certified for Direct Re-Use in accordance with Env-Sw 1500.

**2.1.3.1** Glass cullet shall meet the requirements of AASHTO M318.

**2.2 Gradation.** The required gradation of base course material shall conform to [Table 304-1](#).

**2.3 Sand.** The maximum size of any stone or fragment shall not exceed three-fourths of the compacted depth of the layer being placed but in no case larger than 6".

**2.4 Gravel.** The maximum size of stone particles shall not exceed three-fourths of the compacted thickness of the layer being placed but in no case larger than 6".

**2.5 Crushed gravel.** At least 50 percent of the material retained on the 1" sieve shall have a fractured face.

**2.6 Crushed gravel for shoulder leveling.** This material shall consist either of a crushed aggregate, or a blend of crushed aggregate and reclaimed asphalt or concrete materials. Reclaimed Asphalt Pavement (RAP) and/or Reclaimed Concrete Aggregate (RCA) may be blended up to 75% by volume with the crushed aggregate. The crushed aggregate shall meet the gradation requirements of Item 304.32 in [Table 304-1](#) prior to blending with reclaimed materials. The reclaimed materials shall meet the requirements of 2.6.1 or 2.6.2 as applicable prior to blending with crushed aggregate.

**2.6.1** RAP for this purpose shall be processed by either crushing or screening such that 100% of the material passes the 1" sieve. Screening will only be allowed if the source of the RAP is pavement millings from cold planning bituminous surfaces.

**2.6.2** RCA shall meet the requirements of AASHTO M 319, except for its gradation requirements. 100% of the material shall pass the 1" sieve.

**2.7 Crushed aggregate for shoulders.** This material shall meet the gradation requirements of [Table 304-1](#).

**2.8 Gravel for drives.** The material shall meet the requirements of gravel as shown in [Table 304-1](#).

**2.9 Crushed gravel for drives.** The material shall meet the gradation requirements of either crushed gravel or crushed stone (fine) as shown in [Table 304-1](#).

**2.10 Crushed stone base course (fine gradation).** Acceptable sand may be blended as necessary to obtain the proper gradation for the fine aggregate portion.

**SECTION 304**

**Table 304-1 - Base Course Materials Required Gradation**

Item No.	304.1	304.2	304.3	304.32	304.33	304.4	304.5	304.6
Item	Sand	Gravel	Crushed Gravel	Crushed Gravel for Shoulder Leveling	Crushed Aggregate for Shoulders	Crushed Stone (Fine)	Crushed Stone (Coarse)	Crushed Stone (Very Coarse)
Sieve Size	Percent Passing By Weight							
6"	100	100	---	---	---	---	---	100
5"	---	---	---	---	---	---	---	---
4"	---	---	---	---	---	---	---	---
3 1/2"	---	---	---	---	---	---	100	---
3"	---	---	100	---	---	---	85 – 100	60-90
2 1/2"	---	---	---	---	---	---	---	---
2"	---	---	95 – 100	---	---	100	---	---
1 1/2"	---	---	---	100	100	85 – 100	60 – 90	45-75
1"	---	---	55 – 85	90-100	90 – 100	---	---	---
3/4"	---	---	---	---	---	45 – 75	40 – 70	35-65
1/2"	---	---	---	65-90	---	---	---	---
#4	70 – 100	25 – 70	27 – 52	30-55	30 – 65	10 – 45	15 – 40	15-40
# 200 (In Sand Portion)*	0 – 12	0 – 12	0 – 12	---	---	---	---	---
# 200 (In Total Sample)	---	---	---	0-10	0 – 10	0 – 5	0 – 5	0-5

\* Fraction passing the # 4 sieve

**2.11 Crushed stone base course (coarse gradation).** Acceptable sand may be blended as necessary to obtain the proper gradation for the fine aggregate portion.

**2.11.1** The substitution of crushed stone meeting the requirements of crushed stone base course (fine gradation) for all or part of this item will be permitted.

**Construction Requirements**

**3.1 General.**

**3.1.1** Upon approval, base course materials found within the project limits may be used under the specific item in accordance with 104.04.

**3.1.2** Gravel or approved substitution for gravel may be substituted for any sand course. Crushed gravel may be substituted for gravel. Substitutions must be made across the entire section and will not be allowed for short or discontinuous segments.

**3.1.3** Crushed stone (fine gradation) may be substituted for crushed gravel provided there is a minimum of 1 ft. of free draining material (sand, gravel, crushed stone coarse, or crushed stone very coarse) below the crushed stone. The substitution must be made across the entire section at a constant depth and will not be allowed for short or discontinuous segments.

**3.1.4** Permission may be granted to use the following recycled materials in lieu of crushed gravel or crushed stone (fine gradation) provided the following requirements are met:

- (a) Free draining material exists below the replacement material as described in 3.1.3.
- (b) Substituted materials must come from a homogenous stockpile that meets the gradation requirements of the material being replaced.
- (c) Transitions between replacement material and crushed gravel or crushed stone (fine gradation) shall be made using a 50 ft. taper.
- (d) The material shall be placed directly under the proposed pavement.

**3.1.4.1** Reclaimed asphalt pavement, blended with granular material, shall be tested in accordance with NHDOT test method S1.

**3.1.4.2** Reclaimed concrete aggregate shall also meet the requirements of AASHTO M 319, except for the gradation requirements. The material shall contain no more than 5 percent reclaimed asphalt pavement.

**3.1.5** Crushed stone (coarse or very coarse) may be substituted for gravel provided that all crushed gravel above the crushed stone is replaced with a combination of crushed stone coarse and fine with the top layer consisting of a minimum of 6" of crushed stone fine. The substitution must be made across the entire section and will not be allowed for short or discontinuous segments.

**3.1.6** Crushed aggregate base course materials shall be produced and placed in their final location with as little segregation as possible.

**3.1.7** Excess reclaimed stabilized base material substantially meeting the requirements of 2.7 may be substituted for the crushed aggregate for shoulders in 2.6. Reclaimed stabilized base material shall be mixed with loam as specified in 2.6.

**3.1.7.1** Reclaimed stabilized base material shall not be substituted for crushed aggregate for shoulders in areas contiguous to residences and other existing landscaped areas where the growth of grass is desired.

## **3.2 Aggregate Crushing Plant.**

**3.2.1** The equipment for producing crushed gravel shall be of adequate size and with sufficient adjustments to produce the required materials without unnecessary waste. The plant shall be capable of removing excess fines.

**3.2.2** The equipment for producing crushed stone shall consist of sufficient units with sufficient adjustments to produce the required material. The plant shall be capable of removing undesirable material and excess fines. In order to meet the required gradation, the Contractor may produce acceptable material in one operation or combine coarse and fine piles through a proportioning hopper to create a combined stockpile.

**3.2.3 Glass Cullet Crushing Plant.** The glass cullet crushing plant shall be capable of producing a product meeting the gradation requirements of AASHTO M 318.

**3.2.3.1** Glass cullet shall be thoroughly mixed with other base course materials to produce a homogeneous blend prior to being placed on the roadway. In-place field blending of glass cullet with other base course materials will not be permitted, unless otherwise permitted.

## **3.3 Stockpile Construction.**

**3.3.1** All crushed aggregate base course materials shall be stockpiled. The Contractor shall give the Engineer advance notification of when the manufacturing and stockpiling are to begin.

**3.3.2** A stockpile of acceptable material, as described in 3.5, equal to at least 20 percent of the bid quantity or 5,000 cy, whichever is less, shall be constructed before the hauling and placing phase of the work begins. The stockpile shall be maintained until approximately 80 percent of the quantity has been placed.

**3.3.3** Stockpiles shall be constructed in layers that minimize segregation. The desired optimum thickness of layers is 6 ft. and in no instance shall the layer be more than 10 ft. Each layer shall be completed before the next layer is started. Construction of stockpiles by direct use of a fixed conveyor belt system or by dumping over a bank will not be permitted.

## **3.4 Placing.**

**3.4.1** The subgrade or preceding course shall be shaped to the specified crown and grade and maintained in a smooth condition free of holes and ruts. If the hauling equipment causes ruts in the subgrade or previously placed base course, the equipment shall be operated only on the course being placed, behind the spreading equipment.

**3.4.2** Care shall be taken to avoid segregation during placement. Base course material shall be dumped on the course being placed and spread at once onto the previously placed layer. If spreading equipment is not available, dumping will not be permitted. Any segregation that occurs shall be remedied or the materials removed and replaced at no additional cost to the Department.

**3.4.3** The Contractor's method of operation shall be such that oversized stones will not be delivered to the project.

**3.4.4** When the base course is to be surface-treated and no pavement is to be placed upon it, stones having any dimension greater than 3" shall be removed from the upper 4" of the top layer.

**3.4.5** Prior to fine grading, hard spots in the surface of the top layer shall be eliminated by scarifying the top 4" .

**3.4.6** Crushed gravel for shoulder leveling shall be spread uniformly along the area adjoining the edge of the pavement. The material shall be spread along both sides and under guardrail where there is no curb.

**3.4.6.1** Reclaimed stabilized base material utilized in shoulders greater than 1-1/2", in any direction, shall not be exposed after placement.

## SECTION 304

**3.4.7** To prevent segregation of crushed aggregate during spreading and to assist in obtaining the required density of the mixture, water may be added to the crushed aggregate prior to performing the grading operations. The course shall be maintained in the moist condition during grading operations.

**3.4.8** Crushed aggregate shall be hauled from an approved stockpile. Material obtained directly from a conveyor shall not be placed on the roadway without first stockpiling.

**3.4.9** The base course material shall be spread in the amount necessary for proper consolidation and shall be shaped true to grade and cross-section by means of power graders or other approved equipment.

**3.4.10** Surface voids in crushed stone base course (fine gradation) shall be eliminated by the addition of filler material to just fill the voids. Any surplus filler material shall be removed. The finished surface shall be uniform, true to grade, and free from segregation. The Contractor shall furnish and place filler material to correct any visible segregation prior to paving. The filler material shall be spread, scarified, if required, into the course, and recompacted to the required density. Filler material shall meet the gradation requirements of sand. The final gradation of crushed stone base course (fine gradation) shall meet the requirements of Table 304-1.

### 3.5 Testing For Gradation.

**3.5.1** Sampling procedure shall conform to AASHTO T 2. Testing procedures shall be in accordance with AASHTO T 27.

**3.5.1.1** When reclaimed asphalt pavement is blended with granular material to be used in lieu of crushed gravel or crushed stone base course (fine gradation) the method used to determine the amount of coarse material shall be determined according to NHDOT S-1.

**3.5.2** The amount of material finer than the No. 200 sieve shall be determined according to AASHTO T 11, which specifies dry sieving after washing.

**3.5.2.1** When reclaimed asphalt pavement is blended with granular material to be used in lieu of crushed gravel or crushed stone base course (fine gradation) the method used to determine the amount of material finer than the No. 200 sieve shall be determined according to NHDOT S-1.

**3.5.3** For a preliminary determination of compliance with the specification for gradation, samples of sand and gravel may be taken from the pit, and samples of crushed gravel and crushed aggregate may be taken from the stockpile or from the final phase of the crushing operation. Materials not meeting the gradation requirements shall not be placed on the roadway

**3.5.4** Samples for acceptance testing of the material in place will be taken from each lift. Sampling for acceptance testing will not be done until the material has been graded and compacted.

**3.5.5.** Previously tested and accepted material contaminated by earthen, organic, or other foreign matter or degraded by hauling equipment to such an extent that the material no longer meets the gradation requirements shall be removed and replaced or otherwise made acceptable at the Contractor's expense.

### 3.6 Compaction.

**3.6.1** Unless shown on the plans or ordered otherwise, the compacted depth of sand courses shall not exceed 12". The compacted depth of any layer of gravel, crushed gravel, or crushed stone placed shall not exceed 8".

**3.6.2** Compaction of base course material shall be done with a method and adequate water to meet the requirements of 3.7. Rolling and shaping shall continue until the required density is attained.

**3.6.3** Rolling and shaping patterns shall begin on the lower side and progress to the higher side of the course while lapping the roller passes parallel to the centerline. Rolling and shaping shall continue until each layer conforms to the required grade and cross-section and the surface is smooth and uniform.

**3.6.4** Water shall be uniformly applied over the base course materials during compaction in the amount necessary for proper consolidation.

**3.6.5** When vibratory equipment is being operated, the amplitude of vibrations, the compaction process shall be adjusted as necessary to avoid causing damage or vibration complaints to adjacent buildings and property.

**3.6.6** Except at inaccessible locations, such as near guardrail, material used for shoulder leveling shall be set with a pneumatic-tired roller.



### 3.7 Density Testing.

**3.7.1** The density of sand courses shall be determined by AASHTO T 191 (Sand-Cone Method), AASHTO T 204 (Dry-Cylinder Method), or AASHTO T 310 (Nuclear Methods). The density shall not be less than 95 percent of the maximum density determined in accordance with AASHTO T 99 (Standard Proctor Test) or a control strip per 3.8.

**3.7.2** The density of gravel and crushed gravel courses shall be determined by AASHTO T 191 (Sand-Cone Method) or AASHTO T 310 (Nuclear Methods). The density of crushed stone base courses shall be determined by AASHTO T 310 (Nuclear Methods). The density shall not be less than 95 percent of the maximum density as determined by AASHTO T 99 (Standard Proctor Test) or a control strip per 3.8.

### 3.8 Control Strip Procedure.

**3.8.1** At the beginning of the compaction operation a control strip of at least 100 linear ft. in length and spanning the width of the section being placed shall be constructed. The density requirement shall be determined by compacting the control strip at a suitable moisture content until no further increase in density can be measured. The remainder of the course shall be compacted to a density not less than 95 percent of the maximum control strip density, as measured by the nuclear density testing equipment. A new control strip will be required when there is a significant change in the gradation of the material being placed or a change in compaction equipment. Compaction of the control strip shall be done with approved vibratory rollers or compactors capable of producing a dynamic force of at least 27,000 lb.

**3.8.2** Crushed gravel for roundabout truck apron curb shall be compacted to a density not less than 98 percent of the maximum control strip density, as measured by the nuclear density testing equipment.

### 3.9 Winter Construction.

**3.9.1** Base course materials shall not be placed on or above frozen material if the depth from the top of the contemplated course to the bottom of the frozen material exceeds 2-1/2 ft.

**3.9.2** If the density requirements are not attained for any layer before the material freezes, no further material shall be placed on that layer.

**3.10 Maintenance of Traffic.** Glass cullet base course blends shall be capped with standard specification base course materials before the traveling public is allowed to drive over the material.

#### Method of Measurement

**4.1** Roadbed base course materials of sand, gravel, crushed gravel, crushed aggregate for shoulders, crushed stone (fine gradation), and crushed stone (coarse gradation) will not be measured, but shall be the cubic yard final pay quantity in accordance with 109.11 of compacted material required within the lines shown on the plans.

**4.2** Applicable provisions as stated in 106.02 shall apply to base course materials.

**4.3** Crushed gravel for shoulder leveling will be measured by the ton in accordance with 109.01.

**4.3.1** Reclaimed stabilized base material used for crushed gravel for shoulder leveling shall be measured by the cubic yard using average lengths, widths and depths of the area to be filled or as provided in 4.3 as determined by the Engineer.

**4.4** Gravel and crushed gravel for drives will be measured by the cubic yard of compacted materials placed within the limits shown on the plans.

#### Basis of Payment

**5.1** Roadbed base course materials of sand, gravel, crushed gravel, crushed stone (fine gradation), and crushed stone (coarse gradation) are final pay quantities and will be paid for at the Contract unit price per cubic yard in accordance with 109.11.

**5.1.1** Reclaimed stabilized base authorized for use in lieu of crushed gravel or crushed stone (fine gradation) will be paid for as provided in 5.1.

**5.2** Filler material used to eliminate voids in crushed stone base course (fine gradation) will be subsidiary.

## SECTION 304

5.3 The accepted quantity of gravel, crushed aggregate for shoulders or crushed gravel for drives will be paid for at the Contract unit price per cubic yard complete in place. The accepted quantity of crushed gravel for shoulder leveling will be paid for at the Contract unit price per ton delivered and used on the project.

### Pay items and units:

304.1	Sand (F)	Cubic Yard
304.2	Gravel (F)	Cubic Yard
304.25	Gravel for Drives	Cubic Yard
304.3	Crushed Gravel (F)	Cubic Yard
304.32	Crushed Gravel for Shoulder Leveling	Ton
304.33	Crushed Aggregate for Shoulders	Cubic Yard
304.35	Crushed Gravel for Drives	Cubic Yard
304.4	Crushed Stone (Fine Gradation) (F)	Cubic Yard
304.5	Crushed Stone (Coarse Gradation) (F)	Cubic Yard
304.6	Crushed Stone (Very Coarse)	Cubic Yard

**SECTION 306 -- RECLAIMED STABILIZED BASE****Description**

**1.1** This work shall consist of scarifying, if necessary, and pulverizing the existing pavement together with a base course material. It may require removal and rehandling and the addition of other materials as shown on the plans or as ordered.

**Materials****2.1 General.**

**2.1.1** The material shall consist of the existing pavement blended with the underlying gravel and/or additional stone as required. Reclaimed stabilized base shall have a minimum bitumen content of 1.5 percent and conform to the following gradation:

Sieve Size	Percent Passing By Weight
3"	100
1-1/2"	80 - 100
3/4"	55 - 90
No. 4	40 - 70

**2.1.2** Additional stone as required to meet the above gradation shall meet the requirements of [304.2.1.1](#) and the requirements of Section 703 [Table 703-1](#) – Required Grading, Grading Coarse Aggregates, #467 for 1-1/2" stone.

**2.1.3** Additional asphalt shall meet the requirements of [Section 702](#), as specified.

**Construction Requirements**

**3.1** The reclaimed stabilized base shall be processed, using approved reclaimers. Equipment such as a milling machine or a rock crushing plant will not be permitted. Reclaiming equipment shall be equipped with a gauge to show depth of material being processed.

**3.2** The existing pavement shall be pulverized together with the underlying base course material. The pulverizing operation shall blend the existing pavement and base course into a homogeneous mass, using the bitumen contained in the pavement as a stabilizer. When stone for Reclaimed Stabilized Base [Item 306.36] is included in the Contract or is ordered, the stone shall be applied to the reclaimed surface and re-blended with the previously reclaimed material. The quantity of additional stone mixed with the reclaimed existing pavement shall be adjusted as necessary to meet the material specification of 2.1.1.

**3.3** Prior to compaction water shall be applied, for the purpose of dust control and to ensure proper compaction. Water may be added during fine grading to improve workability. Additional water shall be applied prior to compaction and may require mixing to blend with reclaimed material to ensure adequate compaction.

**3.4** Compaction shall be accomplished by successive passes of a vibratory sheep's foot or pad foot roller of at least 50,000 lb. of dynamic force. Final rolling shall be accomplished by a smooth steel wheel vibratory roller of at least 27,000 lb. of dynamic force. Density testing shall conform to [304.3.8](#).

**3.5** Gradation shall be determined on the total sample prior to extraction by AASHTO T 27. Bitumen content shall be determined on that portion of the sample which passes a 3/4" sieve by AASHTO T 164. The Contractor shall make provisions for an appropriate testing facility for Department personnel to perform the test, AASHTO T 164, as needed.

**3.6** Prior to placing the processed material, the roadbed shall be shaped to the specified crown and grade. If the existing roadbed is disturbed, it shall be compacted in accordance with [304.3.6](#).

**3.7** Excess material, unless specified otherwise, shall become the property of the Contractor.

**3.8** Care shall be exercised to save all pavement for reclaiming if trenches are constructed prior to processing.

**3.9** If the reclaimed stabilized base is not sufficient to complete the project, additional crushed gravel shall be used to make up the deficiency.

**3.10** Reclaimed stabilized base specified to be removed and rehandled may be processed in the roadway or off site. The reclaimed stabilized base shall be returned to the highway and placed on the prepared roadbed to the depths specified.

**3.11** Additional asphalt may be required to obtain the minimum 1.5 percent bitumen content.

**3.11.1** The asphalt shall be applied by a liquid distributor or other approved method, at a rate specified by the Engineer. The asphalt shall be blended with the reclaimed stabilized base using approved mixing equipment.

**3.11.2** Asphalt shall not be applied when rain is threatening, during rain storms, or when the air temperature is below 50°F.

## SECTION 306

**3.11.3** Prior to the addition of asphalt, the moisture content of the reclaimed stabilized base shall be adjusted by aerating or adding water if required.

**3.12** If additional stone is used it shall be blended with the reclaimed material using an approved reclaimer.

### Method of Measurement

**4.1** Reclaimed stabilized base, of the depth specified will not be measured, but shall be the square yard final pay quantity for material within the limits shown on the plans.

**4.2** Additional stone will be measured by the ton in accordance with 109.01. The additional pass with the reclaimer to blend the material will not be measured.

**4.3** Asphalt will be measured by the ton or pound in accordance with 109.01.

### Basis of Payment

**5.1** Reclaimed stabilized base, of the depth specified is a final pay quantity item and will be paid for at the Contract unit price per square yard, complete in place in accordance with 109.11.

**5.1.1** Removal and rehandling or removal of excess material shall be subsidiary to reclaimed stabilized base.

**5.2** The accepted quantity of stone will be paid for at the Contract unit price per ton, complete in place. The additional pass with the reclaimer to blend the material shall be subsidiary.

**5.3** The accepted quantities of asphalt will be paid for at the Contract unit price per ton or pound, complete in place.

### Pay items and units:

306.106	Reclaimed Stabilized Base Processed in Place, 6" Deep (F)	Square Yard
306.108	Reclaimed Stabilized Base Processed in Place, 8" Deep (F)	Square Yard
306.110	Reclaimed Stabilized Base Processed in Place, 10" Deep (F)	Square Yard
306.112	Reclaimed Stabilized Base Processed in Place, 12" Deep (F)	Square Yard
306.206	Reclaimed Stabilized Base Removed and Rehandled, 6" Deep (F)	Square Yard
306.208	Reclaimed Stabilized Base Removed and Rehandled, 8" Deep (F)	Square Yard
306.210	Reclaimed Stabilized Base Removed and Rehandled, 10" Deep (F)	Square Yard
306.212	Reclaimed Stabilized Base Removed and Rehandled, 12" Deep (F)	Square Yard
306.31	Asphalt For Reclaimed Stabilized Base	Pound
306.32	Asphalt For Reclaimed Stabilized Base	Ton
306.36	Stone for Reclaimed Stabilized Base	Ton

## DIVISION 400 – PAVEMENTS

## SECTION 401 -- PLANT MIX PAVEMENTS – GENERAL

## Description

1.1 These specifications include general requirements that are applicable to all types of plant mix asphalt pavements irrespective of the gradation of aggregate, kind and amount of asphalt binder, or pavement use. Deviations from these general requirements will be indicated in the specific requirements for each type.

1.2 These specifications provide for the use of reclaimed asphalt pavement material in certain specified mixtures.

1.3 This work shall consist of the construction of one or more courses of asphalt pavement constructed on a prepared foundation in accordance with these specifications and the specific requirements of the type under Contract. The work shall be in reasonably close conformance with the lines, grades, thickness, and typical cross-sections shown on the plans, within the tolerances specified or established by the Engineer.

1.4 These specifications provide for both method and quality control/quality assurance (QC/QA) specification work. Sections under the heading Performance Requirements (QC/QA) are applicable on QC/QA items only. Sections marked Quality Control (QC/QA) Method are applicable for non-QC/QA items and those portions of QC/QA items that are not measured for pay adjustment. All sections under the heading General are for use with all items.

### 1.5 Performance Requirements (QC/QA).

1.5.1 The work will be accepted under Performance Requirements (QC/QA) provisions in accordance with these Specifications and the applicable requirements of [Section 106](#).

- (a) The QC/QA Tier 1 item is to be used on specified projects that are on new locations, interstate projects, full depth reconstruction projects in rural areas or on reclamation projects in rural areas.
- (b) The QC/QA Tier 2 item is to be used on specified projects that are inlay type projects, full depth reconstruction projects with maintenance of traffic phasing, projects with intersecting streets, projects with pavement tapers, bridge projects with short approach paving, projects where there are many manhole/drainage structures or driveways (generally in urban and suburban areas).

#### QUALITY/PAY FACTORS TO BE ASSESSED

	Tier 1	Tier 2
Asphalt Content and Gradation	X	X
Cross Slope	X	
Density	X	X
Ride Quality	X	
Thickness	X	

#### Materials

### 2.1 Aggregates – General.

2.1.1 Aggregates shall be uniform quality durable pebbles or fragments of rock, with or without sand or other inert finely divided mineral aggregate. All material shall be free from clay balls, organic matter, deleterious substances, and an excess of flat or elongated pieces as specified in ASTM D 4791. Washing will not be required, except when aggregate plants do not produce clean material by the dry process method. In order to obtain uniformity of color and appearance of the pavement throughout the project, the aggregate for all the wearing courses shall be obtained from the same material source. Sufficient material shall be on hand prior to starting daily operations to ensure uninterrupted processing for the working day.

2.1.2 Fine aggregate shall consist of sound durable particles of sand, crushed stone, or a combination thereof. Fine aggregate shall be free from clay balls and injurious amounts of organic matter. Stone screening shall be produced from stone at least equal in quality to that specified for coarse aggregate.

2.1.2.1 Fine aggregate may be 100 percent manufactured aggregate.

2.1.3 Mineral filler shall conform to AASHTO M 17 except that 100 percent shall pass the No 16 sieve, waiving the requirement for the No. 30 sieve.

2.1.4 Coarse aggregate shall be crushed stone or crushed gravel and shall have a percentage of wear as determined by AASHTO T 96 of not more than 45 percent unless otherwise specified by Contract item. In each stockpile, not less than 50 percent by weight of the particles retained on the No. 4 sieve shall have at least one fractured face. Stockpiles consisting of a

## SECTION 401

blend of crushed stone and crushed gravel will be permitted so long as the overall consistency of the stockpile is reasonably maintained and the lesser portion of coarse aggregate material does not exceed 10 percent of the total. This percentage shall be determined on the portion of the total sample by weight that is retained on the No. 4 laboratory sieve.

**2.1.4.1** Coarse aggregate for High Strength HBP shall be crushed stone and shall have a percentage of wear as determined by AASHTO 96 of not more than 45 percent wear.

### 2.2 Bituminous Materials – General.

**2.2.1** Bituminous materials used for asphalt cement binder shall meet the properties specified in AASHTO M 320. The grade of asphalt cement binder to be used will be specified in a Special Provision contained in the Proposal. Asphalt cement shall not be air blown or contain any form of used, recycled or re-refined oil.

**2.2.1.1** The unit bid price for hot bituminous pavement containing failing asphalt binder shall be assessed a 10% reduction for one temperature grade below the specified high temperature grade or one temperature grade above the specified low temperature grade. The penalty will be applied to all tonnage produced with the non-compliant binder. When the binder failure is non-compliant by two grades or more, as described above, the Contractor shall be required to remove and replace all non-compliant material at the Contractor's expense, or at the Engineer's discretion, may be allowed to leave the tonnage in place at a unit price reduction of 50%.

**2.2.2** Liquid binder samples shall be obtained by plant personnel in the presence of the Inspector/Technician. Samples shall be obtained during each day's production.

**2.2.3** Producers and suppliers of asphalt binders shall comply with the requirement of AASHTO R 26. Asphalt binder suppliers shall have a quality control plan approved by the Bureau of Materials and Research that complies with AASHTO R 26.

**2.2.3.1** All suppliers of PG binder shall certify that the PG binder supplied for use on Department projects does not contain used, recycled or re-refined oil.

### 2.3 Approval of Materials - Method Requirements.

**2.3.1** At least five working days in advance of the date of starting operations, the Bureau of Materials & Research may request that representative samples of all materials proposed for use be submitted for testing.

### 2.4 Composition of Mixtures - General.

**2.4.1** Hot mix asphalt shall be composed of a mixture of aggregate, filler if required, and asphalt binder. The several aggregate fractions shall be sized, uniformly graded, and combined in such proportions that the resulting mixture meets the grading requirements of the job mix formula. The Contractor shall use the Volumetric Mix Design Method in AASHTO Standard Practice R 35 as modified herein.

**2.4.2** The Contractor shall have the option of utilizing asphalt pavement removed under the Contract, if any, or old asphalt pavement from an existing stockpile or supplying all new materials for the production of asphalt pavement or any combination of the foregoing. If the job mix formula uses recycled materials, the mix shall meet the requirements of Reclaimed Asphalt Pavement as specified in 2.9.

**2.4.3** The Department allows the use of recycled binder in mix designs, up to 1.0% Total Reused Binder (TRB) without any change in asphalt binder requirements as long as the mix design meets all volumetric mix design criteria. When a design has been completed using the maximum allowable percentage of TRB, one point verifications may be performed using decreasing percentages of TRB. If the design is not validated using a decreased amount of TRB, a new design will be required.

### 2.5 Job Mix – General.

**2.5.1** When a new volumetric mix design is required, the Contractor shall use the Volumetric Mix Design Method in AASHTO Standard Practice R 35 to develop a mix that meets the associated design criteria. The Mix design shall follow the procedure detailed in AASHTO with the following exceptions: Amend Table 1 Superpave Gyrotory Compaction Effort to read as follows:

Design ESALs (Million)	N initial	N design	N max
0 < 5	6	50	75
≥5	7	75	115

Add the following:

## Minimum Binder Content

50 Gyration		75 Gyration	
	3/8"		6.0%
5.8%	1/2"		5.5%
4.9%	3/4"		4.6%
4.6%	1"		4.3%

This required minimum asphalt content is based on the use of aggregate with a specific gravity of 2.65 to 2.70. The minimum asphalt content requirement may be adjusted when aggregate with a higher specific gravity is used, or the minimum may be adjusted at the Engineer's discretion if it is believed to be in the best interest of the Department.

Amend Table 3 in AASHTO M 323, referenced in AASHTO R 35, to read as follows:

Table 401-1 –Design Control Points\*

Standard Sieves	Nominal Maximum Aggregate Size									
	1"		3/4"		1/2"		3/8"		No. 4	
	Max.	Min.	Max.	Min.	Max.	Min.	Max.	Min.	Max.	Min.
Inch	Percentage by Weight Passing Criteria (Control Points)									
2										
1-1/2		100.0								
1	100.0	90.0		100.0						
3/4	90.0		100.0	90.0		100.0				
1/2			90.0		100.0	90.0		100.0		
3/8					90.0		100.0	90.0	100.0	99.0
No. 4							90.0		97.0	90.0
No. 8	45.0	19.0	42.0	32.0	52.0	42.0	56.0	46.0	75.0	65.0
No. 16									55.0	45.0
No. 30									36.0	26.0
No. 50									30.0	20.0
No. 100									13.0	8.0
No. 200	7.0	1.0	8.0	2.0	10.0	2.0	10.0	2.0	8.0	4.0

All mix designs shall be submitted to the Department for verification and approval.

\* Superpave designs will be accepted through the restricted zone, pending verification and approval by the Bureau of Materials & Research. The Contractor shall submit compaction data from trial blends at the optimum asphalt content and at 0.5% below and above the optimum asphalt content. The data shall include the temperature at which the HMA was aged.

2.5.1.1 All 25 mm base course mixes shall be designed using the 50 gyration  $N_{design}$ .

2.5.2 The Design Information shall include:

- (a) Asphalt Binder
- (b) PG Test Data
- (c) Specific Gravity
- (d) Laboratory Mix/Compaction Temperature
- (e) Aggregate
- (f) Dry and Washed Gradation
- (g) Bulk and Apparent Specific Gravity
- (h) All appropriate consensus properties
- (i) Blends
- (j) Baghouse material from the plant shall be incorporated into the mix design. The amount of baghouse material should be based on estimated usage or experience.
- (k) Moisture susceptibility according to AASHTO T 283.

Along with the design information, Materials & Research (M&R) requires 2 quarts of the designated asphalt binder, 4 preblended aggregate specimens for gyratory and 2 preblended aggregate specimens, suitable for AASHTO T-209 when mixed

## SECTION 401

with the appropriate asphalt, in order to verify the design. M&R will accept the mix design based on the submitted information meeting the mix requirements and on verification of the mix volumetrics of the submitted specimen. If the verification samples indicate voids between 3.0 and 5.5 percent, and the Voids in Mineral Aggregate (VMA) and Voids Filled with Asphalt (VFA) fall within the specified limits, then the design will be accepted. Once accepted, the approved mix design is the job mix formula (JMF). If the voids are outside the aforementioned range or the VMA or VFA are outside the specified limits, the design will be rejected. M&R may elect to verify the design again.

**2.5.3** The proposed mix designs and materials shall be submitted to the Engineer a minimum of 20 working days before placement for approval. It shall be the responsibility of the Contractor to ensure all approved mix designs have been entered into the plant automation system before production begins. The Contractor will also be required to post a copy of the JMF in the DOT testing laboratory.

**2.5.4** Whenever the aggregate properties change enough to negate the project's existing design, a new design shall be submitted.

**2.5.5** If it becomes necessary to change the asphalt binder grade or the source of aggregate, a new mix design shall be developed. Up to 14 calendar days will be required to evaluate a change. Approved changes in target values will not be applied retroactively for acceptance or payment. If it becomes necessary to change the source of asphalt binder, the Contractor must submit recent quality test results from the manufacturer for the asphalt binder including a temperature viscosity curve.

**2.5.6** The Contractor shall perform a single point verification of an existing project mix design at the beginning of a new construction season to determine if the design remains valid. If the design is validated, the data from the single point verification shall be submitted to the Department. If the design cannot be validated, a new design shall be developed.

**2.5.7** The Bureau of Materials and Research may require the use of certain chemical additives.

**2.5.8** The laboratory performing the design shall be approved by the Department. To obtain the Department's approval, a laboratory must demonstrate that it is equipped, staffed, and managed so as to be able to produce job mix formulas and test hot asphalt mix in accordance with these Specifications. Approval for each laboratory shall remain in effect for a period of one year.

### 2.6 Method Requirements.

**2.6.1** Stockpiled coarse aggregate shall meet the requirements of Table 401-2.

**Table 401-2 -- Percent Passing**

Sieve Size	Base Mix 1-1/2"	Binder Mix 3/4"	Wearing Mix 1/2"	Wearing Mix 3/8"
1-1/2"	100			
1-1/4"	90.0 - 100			
1"	50.0 - 85.0	100		
3/4"	10.0 - 50.0	90.0 - 100	100	
1/2"		15.0 - 55.0	90.0 - 100	100
3/8"			20.0 - 60.0	95.0 - 100
# 4				22.0 - 55.0
No. 8	0 - 5.0	0 - 5.0	0 - 10.0	0 - 10.0

**2.6.2** After the job mix formula (JMF) is established, all mixtures furnished for the project shall conform within the following ranges of tolerances:

Passing No. 4 and larger sieves	±7.0 percent
Passing No. 8 No. 100 sieves (inclusive)	±4.0 percent
Passing No. 200 sieve	±1.0 percent
Asphalt binder	±0.4 percent
Temperature of mixture	± 20 °F (11 °C)

**2.6.3** When Non-compliant test results, or other conditions make it necessary, it shall be the responsibility of the Contractor to make all adjustments required to ensure the mix conforms to the JMF.



If two consecutive non-compliant results occur, the Engineer may stop production until satisfactory corrective action has been taken. A 5% reduction in unit price will be assessed to all tonnage represented by consecutive gradation failures and a 10% reduction will be assessed to all tonnage represented by consecutive asphalt binder content failures. At the Engineer's discretion, the Contractor may be required to remove non-compliant material (no payment will be made for this material or its removal).

Contractor quality control personnel will not be required to be on site during production of non-quality control projects, but contract information shall be posted in the testing lab.

## 2.7 Performance Requirements (QC/QA).

**2.7.1** After any new changed job mix formula is established, all mixtures furnished for the project shall conform thereto, within the gradation and asphalt binder content reject limits in [Table 401-6](#) in 3.17.3.1.1. Specification limits for pay adjustments under Performance Requirements (QC/QA) provisions shall be as set forth in [Table 401-5](#) in 3.17.3.1.1.

**2.7.2** The general composition limits given in [Table 411-1](#) indicate target value ranges of mixtures permissible under [Section 411](#). The job mix formula shall lie within the target value ranges indicated for the particular type of hot asphalt mix.

**2.8 General** - Bridge pavement base course shall be 3/8" wearing course.

**2.9 General** - Non-modified asphalt binder shall contain silicone additive with the concentration being 3 parts per million plus or minus 1 part per million of silicone to asphalt binder, unless otherwise directed. Silicone additive shall be in liquid form and have a viscosity of 1,000 centipoises (1 Pas) at 77 °F. Asphalt binder containing silicone shall meet the requirements of [401.2.2](#)

## 2.10 Allowed Recycled Materials – General.

**2.10.1** Reclaimed asphalt pavement (RAP) may be used in the production of hot mix asphalt. The allowed dust to asphalt ratio shall be as identified in AASHTO M 323. The maximum allowable total reused “asphalt” binder (TRB) in HMA mixes shall be 1.5%. Any changes in the combination of recycled materials shall require a new mix design unless otherwise approved by the Bureau of Materials & Research.

### 2.10.2 Reclaimed Asphalt Pavement (RAP).

RAP shall consist of recycled asphalt pavement and shall be processed by crushing, cold milling, or other approved sizing techniques approved by the Bureau of Materials and Research to meet the required gradation specifications. The mixture of RAP and new aggregate shall meet the requirements specified in [Table 401-1](#) for aggregate gradation. The RAP shall be tested every 1,000 tons for gradation and asphalt binder content as a stockpile is being built. These test results shall remain on file by the Contactor until such time as the entire RAP stockpile has been utilized.

**2.10.2.1** The PG grade of added asphalt shall be as specified by the Bureau of Materials and Research. The aggregate component of the RAP shall meet the requirements of [401.2.1](#). The bitumen component of the RAP shall be asphalt cement and shall be free of significant contents of solvents, tars, and other volatile organic compounds or foreign substances that will make the RAP unacceptable for recycling as determined by the Bureau of Materials and Research.

**2.10.2.2** RAP materials may be rejected if deemed unsuitable for any reason or require an increase or decrease in the mix asphalt content. The Contractor shall submit representative samples, and gradation and asphalt cement content test results of the RAP to be incorporated into the Recycled Mixture for approval by the Bureau of Materials and Research at least 30 calendar days prior to the start of paving.

**2.10.3** For all designs containing TRB in an amount greater than 1% of the total mix:

- (a) RAP stockpiles shall be covered by a roof.
- (b) Prior to the start of production, the composite RAP and virgin binder shall be tested by the Contractor to determine the appropriate grade of virgin binder to be added.
- (c) Only allowed in a drum mixer.
- (d) Only allowed for binder & base courses.
- (e) Test RAP for gradation & AC% every 1000 tons.
- (f) Run split samples at start of production and every 10k tons thereafter for composite binder testing.

## 2.11 Asphalt Modifiers.

**General.** The generic type of each asphalt binder admixture, modifier and/or additive shall be identified on the certificate of analysis, which shall be furnished by the manufacturer for each load of asphalt delivered. Modifiers shall be pre-blended with the asphalt binder.

## SECTION 401

**2.11.1** Asphalt binder modification to produce high-strength mix shall utilize either a styrene-butadiene or styrene-butadiene-styrene polymer to achieve the specified performance grade of asphalt. The Section 401 contract Special Provision specifying the asphalt binder grade shall also identify the AASHTO test method by which the binder grade shall be determined. The modified binder shall be pre-blended, storage-stable and homogeneous.

**2.11.2** The use of Warm Mix Technologies is permitted in mix production. Qualified technologies are listed on the Qualified Warm Mix Asphalt (WMA) Technologies List.

### 2.12 Pavement Joint Adhesive.

Pavement Joint Adhesive shall be a product that is listed on the [Qualified Products List](#).

**2.12.1** Joint adhesive shall meet the following requirements:

Requirements for Pavement Joint Adhesive		
Property	Test Method	Requirement
Cone Penetration, 25°C	ASTM D 5329	60 -100
Flow, 60°C	ASTM D 5329	5 mm maximum
Resilience, 25°C	ASTM D 5329	30% minimum
Ductility, 4°C	ASTM D 113	30 cm minimum
Tensile Adhesion, 25°C	ASTM D 5329	500% minimum
Softening Point	ASTM D 36	77°C minimum
Asphalt Compatibility	ASTM D 5329	Pass

## Construction Requirements

### 3.1 Mixing Plants.

#### 3.1.1 General.

- Coarse aggregates shall be furnished in at least two nominal sizes for mix types containing top size aggregates of 1/2" and larger.
- RAP shall be fed into the plant by equipment specifically designed for recycling and approved by the Bureau of Materials and Research. In addition, all requirements pertaining to aggregates shall apply to RAP. Scalping screens, grizzlies, or similar devices shall be installed on the RAP feed bin(s) to remove any debris or other foreign materials in excess of 2". If a drum mix plant is used, the RAP shall be fed into the drum so that it will not come in direct contact with the burner flame. Mixing of RAP with the new aggregate shall occur before the bituminous material introduction point. The final mix produced shall be visually free from any chunks of RAP.
- Plants shall be approved at least five days prior to operations and will be capable of maintaining an adequate supply of mixture to the project.

#### 3.1.2 Method Requirements.

- The site shall have ample storage space for the required separate bins, stalls, or stockpiles to allow delivery of uncontaminated sized aggregates to the feeder. To prevent spillage from one pile or bin to the next, aggregate assigned to different stockpiles shall be separated by bulkheads or other satisfactory means.
- Stockpiles of coarse aggregate produced for use in drum mix plants having top size aggregates greater than 3/4" shall be constructed in layers not to exceed 4 ft.
- All blending of aggregates shall be accomplished through separate bins at the cold elevator feeders and not in stockpiles.
- The plant shall be provided with a dust collector or collectors, designed to waste or return uniformly to the hot elevator all or part of the material collected, as directed. All plants shall have adequate covers and housing as may be necessary to ensure the proper collection of dust and the general cleanliness of the plant operation. The Contractor shall comply with all State and Federal environmental regulations.

**3.1.3 Performance Requirements (QC/QA).**

Mixing plants shall conform to AASHTO M 156. An efficient dust collecting system shall be provided to prevent the loss of fine material. The material collected may be returned to the mixture at a uniform rate or discarded.

**3.1.4 Safety Requirements for Inspection – General.**

**3.1.4.1** Adequate and safe stairways to the mixer platform shall be provided, and guarded ladders to other plant units shall be located where required for accessibility to plant operations.

**3.1.4.2** All gears, pulleys, chains, sprockets, and other dangerous moving parts shall be thoroughly guarded and protected.

**3.1.4.3** Ample and unobstructed space shall be provided on the mixing platform. The plant operator shall have a clear and unobstructed view of the plant operations.

**3.1.4.4** A platform shall be located in close proximity to the inspector's laboratory for the purpose of easily obtaining samples of the mixture from the trucks.

**3.1.4.5** When the plant is to be operated in other than daylight hours, adequate lighting shall be provided in all areas frequented by the inspector during his normal routine. Specific areas to be illuminated include the truck loading zone and sampling location. A light or lights shall also be located so as to allow the clear observance of the truck body lubrication operation.

**3.1.5 Scheduling Inspection Personnel - General.**

**3.1.5.1** The Contractor shall notify the Bureau of Materials and Research at least three working days in advance of starting paving operations to allow sufficient time to schedule required plant inspection personnel. When paving bridge decks that have barrier membranes, this notice shall include the name of the membrane product so that the mix temperature may be established.

**3.1.6 Access to Production Facilities – General.**

**3.1.6.1** The Engineer shall have access at any time to all parts of the plant for inspection of the conditions and operations of the plant, for confirmation of the adequacy of the equipment in use, for verification of proportions and character of materials, and for determination of temperatures being maintained in the preparation of the mixtures. The Contractors shall provide a suitable building, room, or trailer for exclusive use by the DOT Technician as a testing laboratory in which to house and use the testing equipment. Laboratories shall be in an approved location, with one laboratory provided for each plant.

**3.1.7 Field Laboratories – General.**

**3.1.7.1** Field laboratories shall meet the following minimum requirements:

Outside Dimensions:	<u>Method Requirements:</u> 16 ft long by 8 ft wide [or equal] by 7 ft high (4.8 m long by 2.4 m wide by 2.1 m high). <u>Performance Requirements (QC/QA):</u> Laboratory shall consist of a minimum of 200 ft <sup>2</sup> of floor space, laid out to accommodate shelves, benches, desk, equipment and personnel movement.
Windows:	Two, with locks and screens, providing cross ventilation.
Doors:	One, with lock and screen.
Electrical:	Adequate lighting and power outlets.
Air Conditioner:	Unit size shall be as recommended for size of the facility.
Heat:	Thermostatically controlled to maintain a minimum temperature of 68°F (20°C).
Weatherproofing:	Roof, sides, and floor shall be maintained weatherproof at all times.
Appurtenances:	a) An exhaust fan and hood over the extractor. The hood shall be large enough to cover the extractor. The fan shall be a high-volume axial-flow fan, at least 10" in diameter, and of sufficient capacity to vent the fumes adequately. b) Free wall space of at least 12 ft <sup>2</sup> ; or a bulletin board of equal area for posting notices and job mix formulas. <u>Method Requirements:</u> Suitable shelves and benches. One bench shall be approximately 24" wide X 36" high and at least 10 ft long. The bench may extend the length of the building.) <u>Performance Requirements (QC/QA):</u> Suitable shelves and benches. Bench space shall be approximately 24" wide by 36" high. There shall be a minimum total length of 19 ft of bench space.

**3.1.7.2** The following office furnishings and testing equipment shall be provided:

- (a) Electronic balance with tray, at least 300 oz net capacity, sensitive to 0.003 oz.
- (b) Desk and chair in good working condition.

## SECTION 401

- (c) Set of U.S. Standard brass sieves, each sieve being 12" in diameter and 1- 1/2" high. The set shall consist of one each of the following sizes: 1- 1/2", 1-1/4", 1", 3/4", 1/2", 3/8", No. 4, No. 8, No. 16, No. 30, No. 50, No. 100, No. 200, with pan and cover.
- (d) Motor driven shaker for 12" diameter sieves. Shaker shall meet the following requirements: Rotating turntable, tilt to 45 degree angle and have hammers to tap each sieve during operation.
- (e) Motor driven centrifuge extractor, 100 oz capacity with variable speed up to 3600 rpm, with filter rings and non-toxic solvent approved by the Bureau of Materials and Research.
- (f) Tachometer readily available to check the speed of the extractor.
- (g) Automatic timer with interval of 0 to 30 minutes.
- (h) Bristle brush for cleaning No. 200 sieve.
- (i) Brass brush for cleaning 8" diameter sieves.
- (j) Five pans or bowls, approximately 4" high, 15" round or square.
- (k) Spatula, large spoon, garden trowel, measuring scoop, and 1 quart pitcher.
- (l) Fire extinguisher, minimum five pound dry chemical.
- (m) Desk brush and floor broom.
- (n) Sample splitter (riffle type), chute width 1- 1/2 to 2"
- (o) Microwave oven when drum mix plant is used.
- (p) Minimum of one metal sample pail for each hot bin.
- (q) Lavatory with toilet (See 698.2.2.4) and wash basin, unless approved otherwise.
- (r) Water, hot and cold, and water suitable for drinking. (Fountain style will be acceptable).
- (s) Telephone with private line.
- (t) Drying oven, minimum of 3.5 ft<sup>3</sup>.\*
- (u) Equipment sufficient to perform AASHTO T 209.\*
- (v) Water cooled diamond saw capable of cutting 6" road cores.
- (w) High Speed Internet Connection - Each laboratory (on State-bid projects) will be provided with bi-directional Internet access having a minimum data rate of 256K bps.
- (x) Wheelbarrow when a drum mix plant is used.

\*All ovens other than microwaves shall be vented to the outside.

**3.1.7.3** All of the foregoing testing equipment shall be in good condition and shall be replaced or repaired by the Contractor if, during the duration of the project, it becomes unsuitable for testing purposes. Testing equipment shall be calibrated by the Contractor in accordance with 106.03. The above mentioned equipment is for operation of a single plant.

### 3.2 Storage of Asphalt Binder – General.

**3.2.1** Tanks for storage of asphalt binder shall be of minimum 10,000 gal capacity and equipped for heating the material under effective and positive control at all times, to the temperature requirements set forth in the specifications for the paving mixture. Heating shall be accomplished by steam or oil coils, electricity, or other means such that no flame shall come in contact with the heating tank.

**3.2.2** A complete system providing for continuous circulation of the asphalt binder between the storage tank and the proportioning units shall be employed. The discharge end of the circulating pipe shall be maintained below the surface of the asphalt binder in the storage tank to prevent discharging the hot asphalt binder into the open air.

**3.2.3** The Contractor shall provide in the asphalt binder feed lines connecting the plant storage tanks to the asphalt binder weighting system or spray bar a sampling outlet consisting of a valve installed in such a manner that samples may be withdrawn from the line slowly at any time during plant operation. The sampling outlet shall be installed between the pump and the return discharge line in such a location that it is readily accessible and free from obstruction. A drainage receptacle shall be provided for flushing the outlet prior to sampling.

### 3.3 Control of Asphalt Binder – General.

**3.3.1** Satisfactory means either by weighing or metering shall be provided to obtain the proper amount of bituminous material in the mix within the tolerance specified. Means shall be provided for checking the quantity or rate of flow of bituminous material into the mixer as follows:

- (a) Metering devices for asphalt binder shall indicate accurately to within 1.0 percent the amount of asphalt binder delivered. The section of the asphalt binder flow line between the charging valve and the spray bar shall be provided with a three-way valve and outlet whereby the quantity delivered by the meter may be checked by actual weight. The valve controlling the flow of asphalt binder to the mixer shall close tightly to prevent asphalt binder from

leaking into the pug mill during the mixing cycle. The meter shall be constructed so that it may be locked at any dial setting to 0.1 gal and will automatically reset to this reading after the addition of asphalt binder to each batch. The dial shall be in full view of the mixer operator. The size and spacing of the spray bar openings shall provide a uniform application of asphalt binder the full length of the mixer in a thin uniform sheet or in multiple sprays.

- (b) If a bucket is used for weighing the asphalt binder, the bucket shall be of sufficient capacity to hold and weigh the amount required for a batch in a single weighing. The filling system and bucket shall be of such design, size, and shape that asphalt binder will not overflow, splash, or spill outside the confines of the bucket during filling and weighing. The filling system and bucket shall be so arranged as to deliver the asphalt binder in a thin uniform sheet or in multiple sprays over the full length of the mixer. The time required to add the asphalt binder shall be not more than 15 seconds.
- (c) Asphalt binder scales shall conform to the requirements for aggregate scales as specified in 3.1.6.7. Beam type scales shall be equipped with a tare beam or adequate counter-balance for balancing the bucket and compensating periodically for the accumulation of asphalt binder on the bucket.

**3.3.2** Suitable means shall be provided, either by steam or oil jacketing or insulation, for maintaining the specified temperatures of the asphalt binder in the pipelines, meters, weigh buckets, spray bars, and other containers or flow line.

### **3.4 Batching Plants – General.**

**3.4.1** All aggregate shall be delivered by belt driven feeders. All feeders shall provide for adjustment of the cold feed and shall be capable of being secured in any position.

**3.4.2** Dryers shall continuously agitate the aggregate during the heating and drying process without leaving any visible unburned oily residue on the aggregate when it is discharged from the dryer. If unusually wet aggregate is being used, the input to the dryer shall be reduced to that amount which the dryer is capable of drying. Aggregates shall be free from coatings of dust after drying.

**3.4.3** Plant screens shall be constructed and operated in such manner that all aggregates will be uniformly separated into the sizes required for proportioning. They shall have sufficient capacity to furnish the necessary quantity of each aggregate size required for continuous operation. Screen cloth that has become broken or has worn sufficiently to affect the gradation shall be replaced.

**3.4.4** Thermometric equipment shall be provided as follows:

- (a) An armored thermometer of suitable range shall be fixed in the asphalt binder feed line at a suitable location near the discharge at the mixer unit.
- (b) The plant shall be further equipped with an approved thermometer, pyrometer, or other approved thermometric instrument that continuously indicates the temperature of the heated aggregate at the discharge chute of the dryer.

**3.4.5** Hot bins shall consist of at least four separate aggregate compartments. One compartment shall be reserved for fine aggregate, and when required, one additional compartment shall be added for dry storage of mineral filler. Alternate bin systems may be utilized with prior approval from the Department. Provision shall be made for accurate proportioning. Each compartment shall contain the following features:

- (a) Sufficient volume to supply the mixer at full rated capacity.
- (b) An overflow pipe that shall be of such size and at such a location as to prevent any backing up of material into other bins or into contact with the screen. Overflow apparatus shall be equipped with a telltale device that alerts the operator and the inspector when the overflow equipment is full.
- (c) Adequate telltale devices to indicate the position of the aggregate in the bins at the lower quarter points.
- (d) Gates that cut off quickly and completely with no leakage.
- (e) Adequate and convenient facilities including safe platforms for obtaining representative samples from each bin.

**3.4.6** Weigh boxes shall be of sufficient size to hold the maximum required weight of aggregate for one batch without hand raking or running over. The weigh box shall be supported on fulcrums and knife edges so constructed that they remain in alignment or adjustment. All parts of the weigh box shall be free from contact with any supporting rods, columns, or other equipment that affects the proper functioning of the hopper or scale. Gates on both bins and weigh hopper shall be constructed to prevent leakage when closed.

**3.4.7** Aggregate scales for any weigh box or hopper shall be of standard make and design and shall be accurate to 0.5 percent of the indicated load. The weight shall be indicated on a digital display. Scales shall be substantially constructed and shall be installed in such a manner as to be free from vibration. The display shall be in full view of the operator, and the numerals shall be of such a size that they can be easily read by the inspector. If the digital display is so located that it is not easily accessible

## SECTION 401

to the inspector, a duplicate display will be required for exclusive viewing by the inspector. The job mix formula target weights shall continuously be part of the digital display during plant operations. The digital scale weight indications shall be displayed adjacent (in juxtaposition) to each target weight for easy comparison to the job mix formula. It shall be the responsibility of the Contractor to ensure that all scales are tested and sealed according to provisions as shown in the National Institute of Standards and Technology Handbook 44, at least on an annual basis. The work shall be accomplished by a competent commercial scale company prior to the start of the construction season. Scales shall be re-tested prior to use, after they have been moved. The Contractor shall have readily available at least ten standard 50 lb weights, for checking the scales during operations.

**3.4.8** The batch mixer shall be of an approved pug mill type, hot oil or steam jacketed, or heated by other approved means and capable of producing uniform mixtures within the specified tolerances. The mixer shall have a batch capacity of not less than 4,000 lb and be constructed so as to prevent leakage during the mixing cycle. The amount of material that may be mixed per batch shall not exceed the manufacturer's rated capacity. If the mixer does not mix properly at the rated capacity, or if its production does not coordinate with the other plant units, the Department reserves the right to reduce the size of the batch until the desired efficiency is obtained. The pug mill shall be equipped with a sufficient number of paddles operated at such speed as to produce a properly and uniformly mixed batch. If, in the course of mixing, two adjacent paddle tips become broken, immediate repair will be called for. If the paddle tips become broken at widely separated points, repair may be delayed until the end of the working day. The clearance of the tips from all fixed and moving parts shall not exceed 3/4". Badly worn or defective tips shall not be used in mixing operations. The mixer shall be covered to prevent loss of fine material. The discharge gate shall be so designed that no uncoated material is retained at the gate opening during the mixing operation. Leakage from the pug mill gate during operation will not be permitted.

**3.4.9** Each plant shall be equipped with an accurate time lock to control the operations of a complete mixing cycle. A mixing cycle shall consist of two periods, the dry mixing period and the wet mixing period. The dry mixing period shall be the interval of time between the opening of the aggregate weigh hopper gate and the start of the application of asphalt binder. The wet mixing period shall be the interval of time between the start of the application of asphalt binder and the opening of the mixer gate. The time lock shall be capable of being set at intervals of five seconds or less throughout the mixing cycle and shall have a suitable case equipped with an approved lock. The setting of time intervals shall be performed in the presence and under the direction of the Engineer who may lock the case until such time as a change is to be made in timing periods. The time lock shall lock the asphalt binder bucket throughout the dry mixing period and shall lock the mixer gate throughout the dry and wet mixing period.

**3.4.10** The use of a fully automatic batching plant will be required and shall meet the following requirements:

- (a) The automatic proportioning controls shall include equipment for accurately proportioning batches of the various components of the mixture by weight in the specified sequence and for controlling and timing the mixing operation. Interlocks shall be provided that delay, stop, or lock out the automatic batch cycling whenever the batched quantity of any component weight or the total batch is not within the specified weight tolerance, or when there is a malfunction in any portion of the control system.
- (b) The automatic control for each batching scale system shall be equipped with a device for stopping the automatic cycle in the underweight check position and in the overweight check position for each material so that the tolerance setting may be checked.
- (c) Each dial scale system shall be equipped with a removable dial puller that can be attached to the dial lever system so that the dial can be moved smoothly and slowly through its range to check the settings of the automatic control system. The plant operator shall perform this automatic control system checkout procedure periodically as requested by the Engineer.
- (d) The weigh batching controls shall meet the following tolerances for the various components weighed in each batch:

<b>Component Weighed</b>	<b>Percentage of Total Batch Weight</b>
Tare weight of aggregate weigh box	±0.5
Tare weight of asphalt binder weigh bucket	±0.1
Each aggregate component	±1.5
Mineral filler	±0.5
Asphalt	±0.1

- (e) The total weight of the batch shall not vary by more than ±2.0 percent of the designated batch weight.
- (f) Recording equipment shall be provided in all plants employing automatic proportioning. Each recorder shall include an automatic printer system. The printer shall be positioned so that the scale reading and the printer can be readily observed from one location by the plant inspector. The printer shall produce, in digital form, a weight slip conforming to the requirements of [109.01](#) and [401.3.8.1](#).

- (g) If at any time the automatic proportioning or recording system becomes inoperative, the plant will not be allowed to operate.

**3.4.11** The aggregate shall be dried and heated to a minimum temperature of 260° F. The asphalt binder shall be heated to a temperature between 260° and 325° F. Each size of hot aggregate, the mineral filler if required, and the bituminous cement shall be measured separately and accurately to the proportions in which they are to be mixed. The mixture shall be made by charging the mixer with the hot aggregate, coarse sizes first, unless otherwise directed, which shall be dry mixed for 5 to 15 seconds. The asphalt binder shall be added and the mixing continued until a uniform coating is obtained and all particles of the aggregate are thoroughly coated. The total dry and wet cycle shall not be less than 35 seconds for base and binder mixtures and not less than 40 seconds for the wearing course. In no case shall the total mixing period exceed 75 seconds.

**3.4.12** If the aggregate in the hot bins contains sufficient moisture to cause foaming in the mixture, such aggregate shall be removed from the bins, and production rate shall be reduced so as not to exceed the capacity of the dryer. Material having once gone through the mixing plant shall not be returned to the stockpiles.

### **3.5 Drum Mix Plants – General.**

**3.5.1** The plant shall be specifically designed for the process and shall be capable of satisfactorily heating, drying, and uniformly mixing the bituminous material and aggregate in accordance with the job mix formula. The rate of flow through the drum shall be controlled in order that a homogeneous mixture is obtained with all particles uniformly coated. In no case shall the quantity of mix produced exceed the manufacturer's rated capacity. If the percent of moisture in the mixture exceeds 1.0 percent by weight, the right is reserved to decrease the rate of production. The plant shall be equipped with automatic burner controls.

**3.5.2** The cold bins shall be divided in at least five compartments and shall be designed to prevent the overflow of material from one bin to another. When reclaimed pavement is used, an additional bin designed for this purpose will be required. In event of an emergency this bin may be used to feed aggregate in an amount not to exceed 15% of material to complete the days production. Each cold bin shall be equipped with an orifice to feed the aggregate accurately and uniformly. The feeding orifice shall be adjustable, and indicators shall be provided to show the gate opening. An automatic plant shutoff device shall be provided to operate when any aggregate bin becomes empty or the flow from any bin gate becomes restricted. A vibrator or other suitable means may be required in order to ensure a uniform flow of materials. The order of aggregate feed onto the composite cold feed belt shall be from coarse to fine.

**3.5.3** The total cold aggregate feed shall be weighed continuously by an approved belt scale. The weighing system shall register within +0.5 percent of the indicated load.

**3.5.4** Proportioning controls for aggregate and asphalt binder shall be located at the panel that also controls the mixture and the temperature. The panel shall be equipped with automatic controls that shall display, in digital form, the percentages of asphalt binder, mineral filler if required, and each aggregate in the job mix formula. The panel shall also be equipped to raise and lower the production rate without having to reset the individual controls for each change in production rate. The controls shall maintain aggregate flow accuracy such that the total variation of all materials being drawn per interval of time shall not exceed an amount equal to 1.5 percent of the total weight of bituminous mixture per interval of time.

**3.5.5** Provisions shall be made for introducing the moisture content of the total cold feed into the belt weighing system and correcting the wet aggregate weight to dry aggregate weight. The system shall be capable of adjusting the flow of bituminous material to compensate for any variation in the dry weight of the aggregate flow. It shall be the responsibility of the Contractor to monitor and determine accurate moisture contents of the aggregate and RAP stockpiles used for production of hot mixed asphalt. Accurate moisture contents shall be determined at a minimum every other day of production. In the event of rain, moisture contents shall be determined for all aggregates and RAP to be utilized before the next day's production.

**3.5.6** The dry weight of the aggregate flow shall be displayed by automatic digital readout in units of weight per interval of time.

**3.5.7** When mineral filler is specified, a separate bin and feeder shall be provided with a variable drive interlocked with the aggregate feeders. Mineral filler shall be introduced and uniformly dispersed into the mixture without loss to the dust collection system. A device shall be provided to indicate when the flow of filler into the delivery system stops or its specified volume is out of job mix tolerance. The rate of flow shall be accurate to within 0.5 percent by weight, of the total mix. Means shall be provided to readily divert the flow of mineral filler into a container for measurement.

**3.5.8** The asphalt binder shall be introduced through a continuously registering cumulative indicating meter by a pump specifically designed for the plant. The meter shall be located in the asphalt line so that it continuously registers the asphalt discharge to the mixer and so that the discharge through the meter can be readily diverted into a suitable container for

## SECTION 401

measurement by actual weight. The meter shall indicate accurately to within 1.0 percent the amount of asphalt binder being delivered. The accuracy of the pump and meter shall be verified at periodic intervals as designated by the Engineer.

**3.5.9** Satisfactory means shall be provided to ensure positive interlock between dry weight of aggregate flow and the flow of bituminous material through an approved meter.

**3.5.10** The flow of bituminous material shall be displayed by automatic digital readouts in terms of volume or intervals of weight and time.

**3.5.11** The plant shall have a means of diverting mixes at start up and shut down or where mixing is not complete or uniform.

**3.5.12** A surge or storage system complying with 3.7 shall be provided.

### 3.6 Mixing Temperature.

#### 3.6.1 Method Requirements.

**3.6.1.1** The Engineer may adjust the job mix formula temperature within the limits of 260° and 350°F according to the existing conditions. Material with a temperature at discharge outside the job mix formula tolerance may be rejected. In no case will a mixture be accepted with a discharge temperature in excess of 375°F.

**3.6.1.2** During hot weather, the temperature of the mixture when discharged shall be as low as is consistent with proper mixing and placing. During cold weather, a temperature approaching the upper limit is desirable.

#### 3.6.2 Performance Requirements (QC/QA).

**3.6.2.1** The job mix formula temperature may be adjusted within the limits of 260 °F and 350 °F according to the existing conditions. Material with a temperature at discharge outside the job mix formula tolerance may be rejected. In no case will a mixture be accepted with a discharge temperature in excess of 375 °F.

### 3.7 Hot Storage System – General.

**3.7.1** Material may be placed in a storage silo for a period not to exceed 24 hours from the time of mixing. The upper and lower gates when closed shall create an airtight seal. The silo shall be filled to capacity. 24 hour storage will not be allowed if there is reason to believe there is a problem with the gate seals or excessive heat loss.

**3.7.2** The hot storage system shall be capable of conveying the hot mix from the plant to insulated and enclosed storage bins and storing the hot mix without appreciable loss in temperature, asphalt migration, segregation, or oxidation.

**3.7.3** The conveyer system may be a continuous type or skip bucket type. If the continuous type is used, it shall be enclosed to prevent a drop in mix temperature. If the skip bucket type is used, the bucket must be of sufficient capacity to transport an entire batch and mass dump it into the bins.

**3.7.4** The storage bins shall be designed in such a manner as to prevent segregation of the hot mix during discharge from the conveyor into the bins and shall be equipped with discharge gates that do not cause segregation of the hot mix while loading the mix into the trucks. The storage bin heating system shall be capable of maintaining the mix temperature without localized heating (hot spots).

**3.7.5** The bin shall be equipped with a light or indicator to show when the level of material reaches the top of the discharge cone. The bin shall not be emptied below the top of the discharge cone until the use of the bin is completed each day. The material remaining in the discharge cone may be rejected if there is evidence of segregation.

### 3.8 Weighing and Hauling – General.

**3.8.1** The Contractor shall provide an approved automatic printer system that prints the weights of the material delivered, provided the system is used in conjunction with an approved automatic batching and mixing control system. Such weights shall be evidenced by a weight slip for each load.

**3.8.2** Weight slips shall include requirements as shown in 109.01 and the following for batch plants with automatic proportioning equipment:

- (a) Tare weight of aggregate weigh box.
- (b) Tare weight of asphalt binder weigh bucket.
- (c) Accumulative weights as batched for each aggregate (total of last aggregate will be aggregate total).
- (d) Weight of asphalt binder.
- (e) Accumulated total weight of batch.



**3.8.3** Each weight slip will show a consecutive load number and shall include an accumulative total of material delivered for each day.

### **3.9 Vehicles – General.**

**3.9.1** The inside surfaces of vehicles may be lightly lubricated with a soap solution or non-petroleum release agent that will not be detrimental to the mix. Equipment that leaks oil, diesel fuel, gasoline, or any other substance detrimental to the pavement will not be allowed on the project.

**3.9.2** The mixture shall be transported from the paving plant to the project in trucks having tight, smooth, metal beds previously cleaned of all foreign materials. Truck beds may be lined with a polyethylene type material designed and installed for hauling hot bituminous mixes. Each load shall be covered with canvas or other suitable material of sufficient size and thickness to retain heat and to protect it from weather conditions. The cover material when new shall weigh a minimum of 18 oz/yd<sup>2</sup> and it shall be a tightly woven or solid material. When necessary, so that the mixture can be delivered on the project at the specified temperature, truck beds shall be insulated, and covers shall be securely fastened.

### **3.10 Placing – General.**

**3.10.1** Prior to placing of any mix, a pre-paving conference shall be held to discuss and approve the paving schedule, source of mix, type and amount of equipment to be used, sequence of paving pattern, rate of mix supply, traffic control, and general continuity of the operation. Special attention shall be made to the paving pattern sequence to minimize cold joints. The field supervisors of the above mentioned operations shall attend this meeting.

**3.10.2** The Contractor shall notify the Engineer at least five working days in advance of paving operations to allow sufficient time to schedule required site inspection and testing. All paving and compaction equipment shall be approved and on site prior to start up each day.

**3.10.3** Crack sealing material to be covered by a 1” or less overlay shall cure a minimum of 45 days prior to the placement of bituminous pavement.

**3.10.4** Base course pavement lifts shall not exceed the maximum compacted thickness of 5 inches. Any course exceeding 5 compacted inches shall be placed in 2 passes.

**3.10.5** When performing paving operations at night, in addition to the requirements of 3.1.4.5, the Contractor shall provide sufficient lighting at the work site to ensure the same degree of accuracy in workmanship and conditions regarding safety as would be obtained in daylight.

**3.10.6** Performance Requirements (QC/QA). The Contractor shall provide the following equipment for testing and sampling at the project site. The equipment shall be in good condition and shall be replaced by the Contractor if, during the duration of the project, it becomes unsuitable for testing or sampling purposes.

**3.10.6.1** Metal plate 12” minimum each side, flat bottom scoop 3000-gram capacity minimum, and sample containers to perform NHDOT B-7 sampling.

#### **3.10.7 Weather Limitations.**

**3.10.7.1 General.** In special instances, when the Engineer determines that it is in the best interest of the State, the Engineer may waive the requirements of 3.10.7, provided that 3.10.7.3 shall always remain in effect.

**3.10.7.2** Any material delivered to the spreader having a temperature lower than 260° F shall not be used unless modified by a qualified warm mix technology capable of being compacted to project requirements at the recommended delivery temperature.

**3.10.7.3** Mixtures shall be placed only when the underlying surface is dry and frost free. The Engineer may permit, in case of sudden rain, the placing of mixture then in transit from the plant, if laid on a base free from pools of water, provided motorist visibility is not impaired and all other specifications are met. No load shall be sent out so late in the day that spreading and compaction cannot be completed during the daylight, unless the requirements of 3.10.5 are met. The Engineer may suspend operations for the day when the Contractor is unable to meet specifications.

**3.10.7.4** All mix placed after October 1<sup>st</sup> and before May 1<sup>st</sup> shall be modified by a qualified warm mix technology.

**3.10.7.4.1** Wearing course shall not be scheduled for placement after October 1<sup>st</sup> and before May 1<sup>st</sup> without written approval by the Engineer.

**3.10.8** At the beginning and end of the project or project section, the existing pavement shall be removed to a sufficient depth to allow the placing of the new pavement and construction of a transverse joint, which shall be painted with a suitable bituminous

## SECTION 401

material. The underlying course shall be clean and free from foreign materials and loose bituminous patches and must present a dry, unyielding surface.

**3.10.9 Sweeping - General.** Existing pavement or previously laid courses shall be thoroughly dry and free from all dust, dirt, and loose material. Sweeping with a power broom, supplemented by hand brooming, may be necessary.

**3.10.10 Tack coat - General.** Surfaces of any pavement course shall have a tack coat of emulsified asphalt applied in accordance with the requirements of 410.3.4.

**3.10.10.1** Tack will be sampled daily and tested by NHDOT for conformance with Section 410. Any pavement that has been placed over tack that is found to be out of specification, but is deemed suitable to remain in place by the Engineer, will be subject to a 3% price reduction. The price reduction will be applied only to the pavement placed on the date that the tack is sampled. This price reduction will not relieve the Contractor of responsibility for latent defects and/or gross mistakes as outlined in section 107.14.

**3.10.11 General - Drainage and utility structures** within the limits of the pavement shall be set and raised in accordance with the provisions of 604.3.4. Contact surfaces of the drainage and utility castings as ordered shall be painted with a thin coating of suitable bituminous material.

### 3.11 Pavers.

#### 3.11.1.1 Pavers shall be:

- (a) Self-contained, power propelled units with adjustable vibratory screeds and full-width screw augers that reach within 18" of the end plate for fixed-width paving.
- (b) Heated for the full width of the screed.
- (c) Capable of spreading and finishing courses of hot asphalt mix in widths at least 12" more than the width of one lane.
- (d) Equipped with a receiving hopper having sufficient capacity to ensure a uniform spreading operation.
- (e) Equipped with automatic feed controls, which are properly adjusted to maintain a uniform depth of material ahead of the screed.
- (f) Capable of being operated at forward speeds consistent with satisfactory laying of the mix.
- (g) Capable of producing a finished surface of the required smoothness and texture without segregating, tearing, shoving, or gouging the mixture.
- (h) Equipped with automatic screed controls with sensors capable of sensing the transverse slope of the screed, and providing the automatic signals that operate the screed to maintain grade and transverse slope from a reference such as a grade wire or ski type device, either a floating beam with a minimum length of 30 ft or sonic averaging with a minimum length of 24 ft.

#### 3.11.1.2 Material Transfer Vehicle (MTV).

An approved MTV shall be used to transfer the bituminous mix from the hauling equipment to the paver. The MTV shall operate independently from the paver and shall be a commercially manufactured unit specifically designed for the transfer of mix from the hauling equipment to the paver without depositing the mix on the roadway. It shall have the ability to swing the discharge conveyor to reach the paver hopper. The MTV shall be designed so that the mix is internally remixed. The minimum storage capacity of the MTV shall be 12 tons.

The MTV will only be required for mainline construction and straight ramps (does not include loop ramps, interim connections, interim crossovers and side roads) when the section is a minimum of 600 tons per paver mobilization unless otherwise approved by the Contract Administrator.

When the MTV passes over a bridge that is not a fill over structure it shall be as near to empty as possible. The MTV also shall not exceed 5 miles per hour while on the bridge. If the Contractor proposes moving the MTV over a bridge with more than a minimal amount of material in it, a proposal must be submitted to and approved by the Bureau of Bridge Design prior to the placing of any mix. The submittal needs to show in detail the wheel and axle loading that will be placed on the bridge deck.

**3.11.1.3** When patching existing pavement, the material shall be placed on the prepared clean underlying surface at the locations designated and shall be spread to produce a smooth and uniform patch. The patch material shall be thoroughly compacted and shall match the line and grade of the adjacent pavement.

**3.11.1.4** Relatively small areas not accessible to the paver may be spread by hand, but extreme care shall be taken to create a surface texture similar to the machine work. Surface material shall be spread by lutes and not by rakes.

**3.11.1.5** Unless otherwise authorized, the final wearing course shall not be placed until guardrail posts have been set and general cleanup has been completed.

**3.11.1.6** When hot bituminous bridge pavement is to be placed over barrier membrane, the placing temperature shall be as specified in 538.3.3.5. A paver, mounted on rubber tracks or tires, shall be used to place the 1" base course unless this procedure is found to cause damage to the membrane. When such damage is found to be evident, the hand method may be allowed. The hand method may also be allowed if the Engineer determines that the use of a paver for this work is impracticable. During warm weather, the above paving shall be done during the cool period of the day. A paver shall be used to place the wearing course.

**3.11.1.7** Where pavement is placed adjacent to structural members such as expansion joints, the material in the top course shall be placed so that the compacted grade of the pavement is 1/4 to 3/8" above the grade of the structural member.

**3.11.1.8** When paving on aggregate base courses and/or base course pavement, the first pass paved shall be on the travel way and on the shoulders.

**3.11.1.9** Pavers used for all 403.11 \_\_\_\_\_ Item work shall have a minimum weight of 28,000 lbs. and a minimum 8-foot wheelbase.

### **3.11.2 Method Requirements**

**3.11.2.1** All courses shall be spread and finished to the required thickness by approved, self-contained, self-propelled spreading and finishing machines (pavers). Pavers shall be provided with an adjustable, activated screed and shall be capable of spreading the mixtures with a finish that is smooth, true to the required cross-section, uniform in density and texture, and free from hollows, tears, gouges, corrugations, and other irregularities. Broadcasting behind the paver shall be held to a minimum. Pavers shall be capable of spreading and finishing courses of the required thicknesses and lane widths. Horizontally oscillating strike-off assemblies will not be approved.

**3.11.2.2** The activated screed shall be of the vibrating or tamping bar type or a combination of both and shall operate without tearing, shoving, or gouging the mixture. The activated portion of the screed shall extend the full width of the mixture being placed in the traveled way and other areas with sufficient width to accommodate a paver. In other locations as permitted such as narrow shoulders, tapers, and areas adjacent to curbs, non-activated extensions to the screed will be allowed. The paver shall be equipped with a screed heater. The screed heater shall be used when starting a cold machine and for maintaining a suitable screed temperature when needed.

**3.11.2.3** Blaw Knox Pavers shall be equipped with the manufacturer's material management kit. The paving Contractor shall certify that this work has been done before using any Blaw Knox paver.

**3.11.2.4** The paver hopper gates shall be adjusted to pass the correct amount of mix to the spreading screws so that the screws operate more or less continuously. The height of material shall be maintained at a constant level in front of the screed, to a point where approximately half of the auger shall be visible at all times.

**3.11.2.5** When required by the Engineer pavers shall be equipped with the following automatic screed controls for each paver:

1. Two 24 ft ski type devices or floating beams.
2. Two grade sensors.
3. Two short skis (joint matchers).
4. Slope sensing control for transverse slope.

The sensors for either or both sides of the paver shall be capable of sensing grade from an outside reference line or from the surface using a ski type device and shall be capable of sensing transverse slope of the screed. The sensors shall provide automatic signals that operate the screed to maintain the desired grade and transverse slope. Pavers shall not be used until the automatic controls have been checked and approved by the Engineer.

**3.11.2.6** The use of automatic grade and slope controls shall be required on all pavers.

**3.11.2.7** Whenever a breakdown or malfunction of the automatic controls occurs, the equipment may be operated manually for the remainder of the normal working day on which the breakdown or malfunction occurred. This method of operation must meet all other specifications.

**3.11.2.8** On projects or parts of projects where the Engineer deems that the use of automatic controls are impracticable, some or all of the controls listed in 3.11.1.5 may be waived.

**3.11.2.9** The forward speed of the paver shall be adjusted to the rate of the supply of materials so that the paver operates without having to make stops except for emergencies. If the Engineer determines that the paving operations result in excessive stopping of the paver, the Engineer may suspend all paving operations until the Contractor makes arrangements to synchronize the rate of paving with the rate of delivery of materials.

## SECTION 401

### 3.11.3 Blank.

### 3.12 Compaction.

**3.12.1 General.** Unless an alternate compaction package is approved at the project pre-pave meeting, roller trains shall consist of the equipment describe herein.

#### 3.12.2 Method Requirements.

**3.12.2.1** Immediately after the hot asphalt mix has been spread, struck off, and surface irregularities adjusted, it shall be thoroughly and uniformly compacted by rolling. The initial rolling shall be done with a static or vibratory steel-drum roller. Intermediate rolling shall be done by a pneumatic-tired roller. Final rolling shall be done with a static steel-drum roller or a roller of the steel-drum three-axle type, locked. The completed course shall be free from ridges, ruts, humps, depressions, objectionable marks, visible segregation, or irregularities and in conformance with the line, grade, and cross-section shown in the Plans or as established by the Engineer. Rollers must be in good mechanical condition, free from excessive backlash, faulty steering mechanism, or worn parts. The empty weight and the ballasted weight shall be properly marked on each roller. The minimum weight of static steel-drum rollers shall be 8 tons. When a vibratory roller is being used, the vibration shall stop automatically when the roller is stopped or reversing direction of travel.

**3.12.2.2** Pneumatic-tire rollers shall be self-propelled and shall be equipped with smooth tires of equal size and diameter. The wheels shall be so spaced that one pass of a two-axle roller accomplishes one complete coverage. The wheels shall not wobble and shall be equipped with pads that keep the tires wet. The rollers shall provide an operating weight of not less than 2,000 lb per wheel. Tires shall be maintained at a uniform pressure between 55 and 90 psi with a 5 psi tolerance between all tires. A suitable tire pressure gauge shall be readily available.

**3.12.2.3** Unless otherwise directed, rolling shall begin at the sides and proceed longitudinally parallel to the roadway center line, gradually progressing to the crown of the roadway. The overlap shall be one-half the roller width for wheeled rollers and 6 in for vibrating rollers. No overlap is required for pneumatic-tired rollers. When paving in echelon or abutting a previously placed lane, the longitudinal joint shall be rolled first followed by the regular rolling procedure. On superelevated curves, the rolling shall begin at the low side and progress to the high side by overlapping of longitudinal passes parallel to the centerline.

**3.12.2.4** Rollers shall move at a slow but uniform speed with the drive roll or drive wheels nearest the paver, except on steep grades. Static and pneumatic-tired rollers shall not operate at speeds in excess of 6 mph. All courses shall be rolled until all roller marks are eliminated.

Cores shall be collected by the Contractor at locations as determined and witnessed by the Engineer. One core per lane mile, but no less than two, shall be taken for each roadway segment paved. When shoulders are overlaid, cores shall be collected solely for density information at a frequency of one core for every 750 tons of mix.

The Contractor will deliver the cores to the designated testing laboratory once NHDOT chain of custody measures have been applied.

The minimum compaction requirement shall be 91% of maximum theoretical density as determined in accordance with AASHTO T 209. The following reductions in unit price shall apply for all tonnage placed that is represented by any core (excluding shoulder cores) that does not meet the minimum requirement: for results below 91% but equal to or greater than 90%, a 5% reduction will be assessed; for any results below 90%, a 10% penalty for all tonnage placed will be assessed. At the Engineer's discretion, the Contractor may be required to remove noncompliant material below 90% (no payment will be made for this material or its removal).

**3.12.2.4.1** All cores need not be cut at the same time. The Contractor is allowed the option to collect cores through all placed lifts at once, provided cores are collected within two working days of placing the first course. Corrective action to any covered course is at the Contractor's risk.

**3.12.2.5** Any displacement occurring as a result of reversing the direction of a roller, or from other causes, shall be corrected at once by the use of lutes and the addition of fresh mixture when required. Care shall be exercised in rolling so as not to displace the line and grade of the edges of the bituminous mixture.

**3.12.2.6** To prevent adhesion of the mixture to the rollers, the wheels shall be kept properly moistened with water or water mixed with very small quantities of detergent or other approved material. Excess liquid will not be permitted. All steel rollers shall be equipped with adjustable wheel scrapers.

**3.12.2.7** Along forms, curbs, headers, and similar structures and other places not accessible to a normal full-sized roller, sidewalk rollers weighing at least 2,000 lb (900 kg) shall be used. Where rollers are impracticable, the mixture shall be thoroughly compacted with heated or lightly oiled hand tamps or vibrating plate compactors.

**3.12.2.8** Unless the Engineer determines that for the weight and placement conditions a lesser number will be satisfactory to obtain the desired pavement densities, the following is the list of required compaction equipment. The output of each paver placing wearing course (Table 1) materials shall be compacted by the use of one each of the following complement of rollers as a minimum: a static or vibratory steel-wheel roller, a pneumatic-tired roller and a three-axle roller or a static steel-wheeled roller. If the required density is not being obtained with the rollers supplied, the use of additional rollers of the specified type may be ordered. Paving widths in excess of 16 ft (5 m) will require additional rollers as ordered.

### **3.12.3 Performance Requirements (QC/QA).**

**3.12.3.1** Immediately after the hot asphalt mix has been spread, struck off, and surface irregularities adjusted, it shall be thoroughly and uniformly compacted. The completed course shall be free from ridges, ruts, humps, depressions, objectionable marks, visible segregation, or irregularities and in conformance with the line, grade, and cross-section shown in the Plans or as established by the Engineer. If necessary, the mix design may be altered to achieve desired results.

**3.12.3.2** All compaction units shall be operated at the speed, within manufacturers recommended limits, that will produce the required compaction. The use of equipment, which results in excessive crushing of the aggregate will not be permitted. Any asphalt pavement that becomes loose, broken, contaminated, shows an excess or deficiency of asphalt binder, or is in any way defective, shall be removed and replaced at no additional cost with fresh hot asphalt mix, which shall be immediately compacted to conform with the surrounding area. Hot asphalt mix shall not be permitted to adhere to the roller drums during rolling.

**3.12.3.3** The type of rollers to be used and their relative position in the compaction sequence shall be the Contractor's option, provided specification densities are attained and with the following stipulations:

- a) At least one roller shall be pneumatic-tired.
- b) Vibratory rollers shall not be operated in the vibratory mode under the following conditions: When checking or cracking of the mat occurs, when fracturing of aggregate occurs, and on bridge decks.

### **3.13 Joints - General.**

**3.13.1** Unless otherwise shown on the plans, the longitudinal wearing course joints shall be at the edge of lane placed, where the edge line, lane line and centerline pavement markings will be applied, and joints of other courses shall be offset approximately 6".

**3.13.2** The material being placed next to a previously paved lane shall be tightly crowded against the face of the abutting lane. The paver shall be positioned so that during spreading, the material will overlap the edge of the first lane by 1 to 2" and shall be left sufficiently high such that finish pavement of the lane being placed is approximately 1/8" higher than the previously paved lane after compaction. The overlapped material shall be rolled without luting. Longitudinal joint compaction shall be achieved by rolling from the hot side to within 6" of the previously placed mat. The next roller pass will overlap onto the previously placed paved lane by 6" Further compactive effort shall be applied to all joints during the intermediate and final rolling.

**3.13.3** Placing of the course shall be as continuous as possible while complying with Contract Traffic Control Plans. Transverse joints will be allowed at the end of each work shift or as required to provide properly bonded longitudinal joints.

**3.13.3.1** No longitudinal joints greater than 1-1/2" height shall be left open to traffic unless a tapered overlapping ("wedge") joint is used. Centerline joints greater than 3/4" shall be properly delineated by tubular marker and signed appropriately. Joints between traveled way and shoulder greater than 3/4" shall be delineated by barrels. Tubular markers and barrels shall meet the requirements of [Section 619](#). Tubular markers shall be secured to the pavement.

**3.13.3.2** Unless otherwise precluded by weather conditions, longitudinal joints shall not remain open to traffic longer than 30 hours.

**3.13.4** If a bulkhead is not used to form the transverse joint, the previously laid material shall be cut back to the designed slope and grade of the course. The joint face shall be coated with approved bituminous bonding material meeting the requirements of [410.2.1](#) before the fresh mixture is placed against it. Extreme care shall be taken to ensure that no unevenness occurs at the joint. If unsatisfactory riding qualities are obtained at the transverse joint in the wearing course, the joint shall be corrected by an approved method.

**3.13.4.1** Prior to opening any lane(s) to traffic, transverse joints shall be ramped by means of an asphalt fillet at a minimum of 5 ft. horizontal to 1" vertical slope.

**3.13.4.2** When paving into a permanent transverse joint, a full head of material shall be carried into the joint.

## SECTION 401

**3.13.5** When specified, a bituminous pavement joint adhesive, Item 403.6, shall be applied to the longitudinal joint. If joint adhesive has not been specified, an approved bituminous bonding material meeting the requirements of 410.2.1 shall be applied to completely cover all joint contact surfaces.

**3.13.5.1** Joint adhesive shall be applied to the longitudinal joints so that the entire joint surface is covered with a minimum 1/8" thick layer of material. If a wedge joint is used the upper 4" of joint surface shall be covered with joint adhesive. In lieu of using joint adhesive, the Contractor may elect, with the approval of the Engineer, to use multiple pavers in echelon to eliminate the longitudinal joint. Echelon paving shall be performed as stated in 3.13.8.

**3.13.5.2** The joint face on which the joint adhesive is to be applied shall be dry, free from loose material, dust, or other debris that could interfere with adhesion. If dust or debris adheres to the joint adhesive, it shall be cleaned or recoated as directed by the Engineer.

**3.13.5.3** Trucks or traffic shall not drive across the joint adhesive until it has cooled sufficiently to prevent damage from tracking.

**3.13.5.4** Joint adhesive shall be melted in a melting kettle that meets the requirements of 413.2.2(b). The joint adhesive shall be applied at the temperature specified by the manufacturer and shall not be heated above the safe heating temperature specified by the manufacturer.

**3.13.5.5** Joint adhesive shall be applied using a pressure feed wand applicator system equipped with an applicator shoe as recommended by the manufacturer. A pour-pot applicator will be allowed on wedge joints only.

**3.13.5.6** Joint adhesive (Bridge Base) shall be applied to curbs, concrete armoring, and pavement matches so that the entire joint is covered with a minimum 1/8" thick layer of material.

**3.13.6** A tapered overlapping ("wedge") joint may be used on all longitudinal joints provided that the adjacent lane can be placed when the existing surface temperature is above 50° F.

**3.13.6.1** An inclined face (3:1) on the joint shall be formed in the first bituminous mat placed. The inclined face may be for the entire height or an inclined face with a 1/2" maximum vertical face at the top of the mat.

**3.13.6.2** After the initial mat is placed, the mat shall be rolled to the edge of the unconfined face.

**3.13.6.3** When the adjoining mat is placed the initial longitudinal wedge shall be treated as in 3.13.5.

**3.13.6.4** The joint matching and compaction shall be performed in accordance with 401.3.13.

**3.13.7** The Contractor shall furnish and have available a 10 ft, light-weight metal straightedge with a rectangular cross-section of 2 by 4" at the paver at all times during paving operations. All courses shall be tested with the straightedge laid across the transverse joint parallel to the centerline and any variations from a true profile exceeding 3/16" shall be satisfactorily eliminated. The finished surface of the pavement shall be uniform in appearance, shall be free from irregularities in contour, and shall present a smooth-riding surface.

**3.13.8 Echelon Paving.** Echelon paving, when specified or approved, shall be defined as multiple pavers paving simultaneously and adjacent to one another such that all rolling of both mats is performed concurrently.

### **3.14 Variations in Profile and Cross Slope – Method (See 3.17.3.4.1).**

**3.15 Replacement – General.** If unsatisfactory areas are found in any course, the Contractor shall remove the unsatisfactory material and replace it with satisfactory material.

**3.16 Finished Appearance – General.** Any bituminous material remaining on exposed surfaces of curbs, sidewalks, or other structures shall be removed.

### **3.17 Additional Performance Requirements (QC/QA).**

#### **3.17.1 Quality Control.**

**3.17.1.1** The Contractor shall operate in accordance with a Quality Control Plan, hereinafter referred to as the "Plan", sufficient to assure a product meeting the Contract requirements. The plan shall meet the requirements of 106.03.1 and these special provisions.

**3.17.1.2** The Plan shall address all elements which affect the quality of the Plant Mix Pavement including, but not limited to, the following:

- (a) Job mix formula(s).

- (b) Hot asphalt mix plant details.
- (c) Stockpile Management.
- (d) Make & type of paver(s).
- (e) Make & type of rollers including weight, weight per inch (centimeter) of steel wheels, and average ground contact pressure for pneumatic tired rollers.
- (f) Name of Plan Administrator.
- (g) Name of Process Control Technician(s).
- (h) Name of Quality Control Technician(s).
- (i) Mixing & Transportation.
- (j) Process Control Testing.
- (k) Placing sequence and placing procedure for ride quality.
- (l) Paving and Weather Limitations.
- (m) Sequence for paving around catch basins, under guard rail, around curb, at bridges, and intersections, drives and minor approaches, to ensure a proper finish and drainage.
- (n) Procedure for fine grading the top of the surface to be paved.

**3.17.1.3** The Plan shall include the following personnel performing the described functions and meeting the following minimum requirements and qualifications:

**A. Plan Administrator** shall hold certification as NETTCP QA Technologist and meet one of the following qualifications:

- (a) Professional Engineer with one year of highway experience acceptable to the Department.
- (b) Engineer-In-Training with two years of highway experience acceptable to the Department.
- (c) An individual with three years highway experience acceptable to the Department and with a Bachelor of Science Degree in Civil Engineering Technology or Construction.
- (d) An individual with five years of paving experience acceptable to the Department.

**B. Process Control Technician(s) (PCT)** shall utilize test results and other quality control practices to assure the quality of aggregates and other mix components and control proportioning to meet the job mix formula(s). The PCT shall periodically inspect all equipment used in mixing to assure it is operating properly and that mixing conforms to the mix design(s) and other Contract requirements. The Plan shall detail how these duties and responsibilities are to be accomplished and documented and whether more than one PCT is required. The Plan shall include the criteria utilized by the PCT to correct or reject unsatisfactory materials. The PCT shall be certified as a Plant Technician by the New England States Technician Certification Program or be a Materials Testing Technician in Training, working under the direct observation of a NETTCP certified Plant Technician.

**C. Quality Control Technician(s) (QCT)** shall perform and utilize quality control tests at the job site to assure that delivered materials meet the requirements of the job mix formula(s). The QCT shall inspect all equipment utilized in transporting, laydown, and compacting to assure it is operating properly and that all laydown and compaction conform to the Contract requirements. The plan shall detail how these duties and responsibilities are to be accomplished and documented, and whether more than one QCT is required. The Plan shall include the criteria utilized by the QCT to correct or reject unsatisfactory materials. The QCT shall be certified as a HMA Paving Technician as certified by the North East Transportation Training and Certification Program or be a Materials Testing Technician in Training, working under the direct observation of a NETTCP certified HMA Paving Technician.

**3.17.1.4** The Plan shall detail the coordination of the activities of the Plan Administrator, the PCT and the QCT. The Plan shall also detail who has the responsibility to reject material, halt production or stop placement.

**3.17.1.4.1** All issues agreed to at the Pre-Paving meeting shall be considered to be part of the Plan.

**3.17.1.5** Asphalt pavement shall be sampled, tested, evaluated and recorded by the Contractor in accordance with the minimum process control guidelines in Table 401-3.

**3.17.1.5.1** Cross slope shall be measured on every pavement lift using the method described in 3.17.3.5.1 prior to placement of subsequent lifts. Particular emphasis on the first pavement lift shall be required when correcting existing substandard cross slopes. Cross slope measurements exceeding 0.5% from the specified cross slope for that location shall require an adjustment in ongoing or subsequent paving operations to correct the deficiency. If two or more consecutive measured sublots are greater than 0.5% from the specified cross slope, paving operations shall cease until the Contractor submits a corrective action satisfactory to the Engineer.

**SECTION 401**

**Table 401-3 - Minimum Process Control Guidelines**

<b>Properties</b>	<b>Test Frequency</b>	<b>Test Method</b>
Temperature of Mix	6 per day at paver hopper and plant	
Surface Temperature	As needed	
Temperature of Mat	4 per day	
Density	1 per 500 tons (500 metric tons) or minimum 2 per day	AASHTO T 343 or ASTM D 2950
Maximum Theoretical Specific Gravity	1 per day of operation	AASHTO T-209
Fractured Faces	1 per 2000 tons (1800 metric tons) for Gravel Sources only	AASHTO T 11 & AASHTO T 27
Aggregate Gradation & Asphalt Binder content	1 per 750 tons (700 metric tons) recommended	AASHTO T 130 & 164
Asphalt Binder Thickness	As needed Contractor Defined	AASHTO M 226 M 320 Contractor Defined
Cross Slope	1 per 5 full stations	Per 3.17.3.5.1

**3.17.1.6 Rejection by Contractor.** The Contractor may, prior to sampling, elect to remove any defective material and replace it with new material at no expense to the Department.

**3.17.1.6.1** No wearing course pavement shall be removed or repaired without prior approval of the Engineer.

**3.17.1.7** The Contractor may utilize innovative equipment or techniques not addressed by the specifications or these provisions to produce or monitor the production of the mix, subject to approval by the Engineer.

**3.17.2 Quality Assurance.**

**3.17.2.1** Asphalt pavement designated for acceptance under Quality Assurance (QA) provisions will be sampled once per subplot on a statistically random basis, tested, and evaluated by the Department in accordance with 106.03.2 and the acceptance testing schedule in Table 401-4. Testing shall not take place until the material has been placed and deemed acceptable by the Contractor.

**Table 401-4 - Acceptance Testing Schedule**

<b>PROPERTIES</b>	<b>POINT OF SAMPLING</b>	<b>LOT SIZE</b>	<b>SUBLOT SIZE</b>	<b>TEST METHOD</b>
Gradation	Behind paver & before rolling <sup>(4)</sup>	401.3.17.2.2	750 tons	AASHTO T 30 NHDOT B-1
Asphalt Binder content	Behind paver & before rolling <sup>(4)</sup>	401.3.17.2.2	750 tons	AASHTO T 164 NHDOT B-2 NHDOT B-6
Maximum theoretical specific gravity	Compacted Roadway <sup>(1)</sup> Core		750 tons	NHDOT B-8 AASHTO T 209
In Place Air Voids in total mix <sup>(5,6,7)</sup>	Compacted roadway <sup>(1)</sup> core	401.3.17.2.2	750 tons	NHDOT B-8 AASHTO T 269
Ride Smoothness <sup>(7)</sup>	Completion of wearing surface	Total project	0.1 lane mile	401.3.17.3.4
Cross Slope <sup>(7)</sup>	Completion of wearing surface	Total project	1 per 5 full stations	401.3.17.3.5
Thickness <sup>(2)(5)(7)</sup>	Compacted roadway <sup>(1)</sup> core	Total project	750 tons	NHDOT B-8 ASTM D 3549

<sup>1</sup>. Excluding bridge pavements.

<sup>2</sup>. Measurements taken from full depth cores obtained for in place air voids determination.

<sup>3</sup>. For leveling course, samples to be taken at the plant.

<sup>4</sup>. Sampling and testing will not be done for leveling course.



5. Not Including leveling course.
6. When the Contractor is supplying mix to more than one paver simultaneously, Contractor's personnel shall keep a running total of tonnage supplied to each paver on each paver.
7. Tier 1 Item only.

**3.17.2.2 Lot Size.** For purposes of evaluating all acceptance test properties a lot shall consist of the total quantity represented by each item listed under the lot size heading in the table above, up to 15,000 tons. For Items with quantities in excess of 15,000 tons, lot sizes will be determined at the pre-placement meeting. Each lot will be broken down into at least 3 sublots.

The Contractor may request a change in the job mix formula. If the request is approved, all of the material produced prior to the change will be evaluated on the basis of available tests and a new lot will begin. Three sublots must be sampled and tested before a new lot may begin.

**3.17.2.2.1** A lot for Gradation, Asphalt Content and In Place Air Voids shall be the total quantity represented by the job mix formula with the following exception; the shoulders will be evaluated as a separate lot for in place air voids.

**3.17.2.3 Sublot Size.** The quantity represented by each sample will constitute a sublot. The size of each sublot shall be as listed under the sublot size heading in Table 401-4. If there is insufficient quantity in a lot to make up at least three sublots of the designated size in Table 401-4, then the lot quantity will be divided into three equal sublots.

If there is less than one half of a sublot remaining at the end, then it shall be combined with the previous sublot. If there is more than one half sublot remaining at the end, then it shall constitute the last sublot and shall be represented by test results.

**3.17.2.4 Test Results.** The Engineer may calculate pay factors and pay adjustments at any time while a lot is being produced. This may be necessary for a partial estimate or to see if quality is falling to a point where immediate attention is required. Pay factors will be determined from all available acceptance tests for the lot being evaluated.

### 3.17.3 Acceptance Testing

**3.17.3.1 Gradation and Asphalt Binder Content.** Samples for gradation and asphalt binder content shall be obtained from behind the paver in conformance with NHDOT procedure B-7 (see appendix A) and taken from each pavement layer by the Contractor in the presence of the Engineer. The sample locations will be established by selecting a random location within each sublot in accordance with [Section 106](#). Sample locations (center of sample) will not be within 1 foot from an edge of pavement or within 4 feet from any structure. Sample locations falling within 4 feet from any structure will be relocated 4 feet from the structure along station at the same offset.

Where samples have been taken, new material shall be placed and compacted to conform to the surrounding area immediately after the samples are taken. Samples shall be accompanied by a sample tag containing the following information:

- a) Project name and number.
- b) Lot and sublot number.
- c) Material type.
- d) Date placed.
- e) Location in station and offset, tonnage
- f) Contract Administrator
- g) Sampler
- h) Item number

When the project exceeds 30 minutes travel time from the testing laboratory location, material samples will be taken and identified by NHDOT project personnel and shall be transported before cooling by the Contractor and delivered to NHDOT testing technicians at the testing laboratory location. Samples lost in transit will incur a penalty of 5% of the bid price for the entire sublot represented by that sample. Sublots with no test results due to a lost sample will not be evaluated and the total quantity represented by that sublot shall not be included in any positive pay factor.

**3.17.3.1.1 Testing.** Target values shall be as specified in the job mix formula. All sieve sizes specified in the job mix formula will be evaluated for gradation. The specification limits in Table 401-5 will be used for calculating pay factors for gradation and asphalt binder content.

**SECTION 401**

**Table 401-5 - Gradation and Asphalt Binder Specification Limits**  
**Property** **Maximum Aggregate Size**

	1"	3/4"	1/2"	3/8"
	USL and LSL (Target +/- %)			
1 1/2"	0			
1-1/4"	8.0			
1"	8.0	0		
3/4"	7.0	5.0	0	
1/2"	7.0	5.0	4.0	0
3/8"	7.0	5.0	4.0	4.0
No. 4	4.0	4.0	3.0	4.0
No. 8	4.0	4.0	3.0	3.0
No. 16	2.0	2.0	2.0	2.0
No. 30	2.0	2.0	2.0	2.0
No. 50	2.0	2.0	2.0	2.0
No. 100	2.0	2.0	2.0	2.0
No. 200	0.8	0.8	0.8	0.8
Asphalt Binder	0.4	0.4	0.4	0.4

Any subplot with a gradation or asphalt binder content falling outside the ranges of the reject limits in Table 401-6 will be either removed and replaced at the expense of the Contractor or require corrective action to the satisfaction of the Engineer. After replacement or correction, new samples will be taken and the old test results from that subplot will be discarded.

**Table 401-6 - Gradation and Asphalt Binder Content Reject Limits (Deviation from Target)**

SIEVE SIZE	1"	3/4"	1/2"	3/8"
	Percent Passing By Weight – Combined Aggregate			
1-1/4"				
1"				
3/4"	±12	(1)		
1/2"	(1)	±10	(1)	
3/8"	(1)	(1)	±10	(1)
No. 4	±9	±9	±9	±9
No. 8	±7	±7	±7	±7
No. 16	±6	±6	±6	±6
No. 30	(1)	(1)	(1)	(1)
No. 50	(1)	(1)	(1)	(1)
No. 100	(1)	(1)	(1)	(1)
No. 200	±3	±3	±3	±3
Asphalt Binder: % of Mix	±1.0	±1.0	±0.8	±0.8

(1) Reject limits will be waived for these sieves.

The Contractor shall have the option of requesting a change in job mix formula (aim change) values used for calculating quality level to reflect actual production values after the placement of two sublots as long as no change in plant production values are made. A new lot is not needed for this change.

**3.17.3.2 In Place Air Voids.** In place air voids shall be determined in accordance with AASHTO T 269 using 6" diameter cores taken from each pavement layer by the Contractor in the presence of the Engineer. Core sampling shall be in conformance with ASTM D 5361 and NHDOT B-8 (see Appendix A). Full depth cores containing all new pavement layers shall be required. Core locations (center of core) will be established by selecting a random location within each subplot in accordance with [Section 106](#). When shoulders are overlaid, cores shall be collected solely for density information at a frequency of one core for every 750 tons of mix. Cores will not be located in the following areas:

- (a) Within 1 foot from an edge of pavement.

- (b) Within 4 feet from any structure. Core locations falling within this area will be relocated 4 feet from the structure along station at the same offset.
- (c) Within shoulders 4 feet or less in width.
- (d) Within 1 foot from any break in slope across the mat surface.

Cores shall be taken before opening pavement to traffic, except when location of core is within the last hour of that day's placement. Cores shall be taken within 24 hours after placement. Where cores have been taken, new material shall be placed and compacted to conform to the surrounding area the same day the samples are taken. Core samples shall be accompanied by a sample tag containing the following information:

- (a) Project name & number.
- (b) Lot and subplot number.
- (c) Material Type.
- (d) Date placed.
- (e) Date sampled.
- (f) Location in station and offset, and/or tonnage.
- (g) Plan thickness.
- (h) Contract Administrator
- (i) Sampler
- (j) Item number

The complete sample(s) (unseparated) shall be protected against damage, transported and delivered by the Contractor within one working day to NHDOT testing technicians at the testing lab location. Sublots where the core becomes lost or damaged will be resampled at the direction of the Engineer at the Contractor's expense.

The specification limits in Table 401-7 will be used for calculating pay factors for in place air voids for each lot:

**Table 401-7 - In Place Air Voids Acceptance Limits**

TARGET (%)	LSL	USL
Average of Samples	- 2.0% <sup>1</sup>	+2.0% <sup>2</sup>

<sup>1</sup> But not less than 2.5%

<sup>2</sup> But not more than 9%

When a core is less than 80% of the nominal thickness, a new core will be taken in the same subplot at a random location for the determination of in place air voids.

A subplot with a test result less than 2.0% for in place air voids will be rejected and subject to removal and replacement.

**3.17.3.2.1 Maximum Theoretical Density (MTD).** MTD shall be determined in conformance with AASHTO T 209 once per subplot from the core obtained for determining in place air voids.

**3.17.3.2.2 Disputed Cores.** If a Contractor believes that a core result is invalid for whatever reason, the Contractor shall notify the Engineer of this in writing within 24 hrs. of being informed of the test result. After being informed of the disputed core result, the Engineer will select three random core locations, one in each three sections of the disputed subplot at the same offset as the disputed core. The Contractor shall cut the cores at the selected locations in the presence of the Engineer who shall place them in secured containers for delivery and testing at the Bureau of Materials and Research laboratory in Concord, NH. If there are 10 or more cores already tested to date, the pay factor for voids in the lot will be calculated (without using the result of the disputed core). If less than ten cores have been tested in the disputed lot, the three cores shall be held until ten cores have been tested or the lot is complete, whichever comes first, at which time the pay factor will be calculated.

If the pay factor for the lot that contains the disputed result is 0.95 or greater, and the disputed test result is outside three standard deviations from the mean value of the lot (calculated without using the result of the disputed core), the three cores shall be tested and the average value of the three will be calculated.

If any of these three cores falls outside three standard deviations from the mean value for the lot (calculated without using the result of the disputed core), the original core test value will stand. If the three cores fall within three standard deviations of the mean value the average of the three cores will be used as the core result for the disputed subplot.

If the three cores are not used, the Contractor shall pay for the cost of testing.

**3.17.3.3 Pavement Thickness.** The thickness requirements contained herein shall apply only when each pavement layer is specified to be a uniform thickness greater than 3/4". The thickness of each layer of hot asphalt mix will be measured in

## SECTION 401

conformance to ASTM D 3549 to determine compliance with the acceptance tolerance. Measurements shall be obtained from cores taken for determining in place air voids of each pavement layer. A leveling course, or the first layer over a gravel or stone base, a milled surface or an existing surface, shall be excluded from thickness measurement.

**3.17.3.3.1** Once each thickness measurement has been taken, a thickness index will be calculated. The thickness index is the actual deviation from target divided by the allowable tolerance. This will allow statistical comparisons to be made among measurements based on varying specified thickness. Thickness indexes will be established for the sole purpose of calculating pay factors. Thickness index shall be calculated under the following equation using the specification limits in Table 401-8.

$$TI = (M - ST)/T$$

where: TI = Thickness Index  
ST = Specified Thickness  
M = Measured Layer Thickness From Core  
T = 15% x ST, but no less than 1/4"

**Table 401-8 -Thickness Index Acceptance Limits**

	TARGET	LSL	USL
Thickness Index	0.00	-1.00	+1.00

**3.17.3.3.2 Disputed Thickness** If a Contractor believes that a thickness result is invalid for whatever reason, the Contractor shall notify the Engineer of this in writing within 24 hrs of being informed of the test result. After being informed of the disputed result, the Engineer will select three random core locations in the disputed subplot and the Contractor shall cut the cores at the selected locations in the presence of the Engineer who shall place them in secured containers for delivery and testing at the Bureau of Materials and Research laboratory in Concord, NH and deliver them to the testing technician. If there are 10 or more cores already tested to date, the pay factor for thickness in the lot will be calculated (without using the result of the disputed core). If less than ten cores have been tested in the disputed lot, the three cores shall be held until ten cores have been tested or the lot is complete, whichever comes first, at which time the pay factor will be calculated.

If the pay factor for the lot that contains the disputed result is 0.95 or greater, and the disputed test result is outside three standard deviations from the mean value of the lot (calculated without using the result of the disputed thickness), the three cores shall be measured and the average value of the three will be calculated.

If any of these three cores falls outside three standard deviations from the mean value for the lot (calculated without using the result of the disputed core), the original thickness test value will stand. If the three cores fall within three standard deviations of the mean value the average of the three measurements will be used as the thickness for the disputed subplot.

If the three cores are not used, the Contractor shall pay for the cost of testing.

### **3.17.3.4 Ride Smoothness.**

**3. 17.3.4.1** The Contractor shall furnish and have available a 10 ft., light weight metal straightedge with a rectangular cross section of 2" x 4" at the paver at all times during paving operations. All courses shall be tested with the straightedge laid parallel or perpendicular to the centerline and any variations from a true profile or cross slope exceeding 3/16" shall be satisfactorily eliminated. The finished surface of the pavement shall be uniform in appearance, free from irregularities in contour and shall present a smooth-riding surface.

**3. 17.3.4.2** A GM type profilometer will be furnished by the Department for determination of pavement smoothness. This device provides a Ride Number in both wheel paths that are averaged to produce a ride number for the surface tested. In the event the Engineer feels that there is a significant difference in the wheel path profiles, a Ride Number evaluation of the individual wheel paths will be made. The surface will be tested within 30 days after the wearing surface and pavement markings for each discrete section of the project are complete. Immediately before testing, the Contractor will ensure the surface is entirely free from any foreign matter that may affect the test results. No special considerations will be given to criteria such as degree of curve and vertical geometry. Ride Number will be calculated to the nearest one hundredth for each 0.1 mile segment.

**3. 17.3.4.3** Profilometer testing will include all mainline paving including bridges with lanes at least 11 feet wide. Testing will begin 20 feet after the approach joint and end 20 feet before the departure joint. The pavement will not be evaluated over bridge expansion joints, tapers, raised pavement markings, and sections less than 0.1 mile in lane length.

**3. 17.3.4.4** All areas with bumps or high points exceeding 0.3" in 25 feet shall be corrected by removal of a minimum of 1" of the full lane width by the length required (a minimum of 100 feet) and replaced at the Contractor's expense.

3. 17.3.4.5 The Ride Number average of all sublots will be used to determine the final pay factor. The final pay factor shall not exceed 1.05 and will be computed as follows:

**For Level 1 Projects:** (Ride Number 4.20)  
Pay Factor = RN (0.5)-1.1

**For Level 2 Projects:** (Ride Number 4.14)  
Pay Factor = RN (0.5682) – 1.3523

3. 17.3.4.6 A final Ride Number shall be established after the wearing surface is completed and striped. Separate completed sections of a project will be evaluated before the entire wearing surface is completed. Any subplot with a ride number less than 3.7 shall be repaired or replaced.

3.17.3.4.6.1 Any subplot that has an individual wheel path ride number less than 3.7 shall be repaired or replaced. The repair treatment shall be for the full width of the lane. Sublots that have been repaired or replaced shall be reevaluated for ride smoothness and then averaged with all other sublots to determine the final project pay factor. Construction joints resulting from repairs or replacement will be included.

3. 17.3.4.6.2 Level 1 will generally be all interstate and limited access highways with the following exception:

- (a) A single course overlay that has a before ride number average of less than 4.00.

3. 17.3.4.6.3 Level 2 will generally be all other highways with the following exceptions:

- (a) Where the wearing course must be constructed in short sections (< 3 sublots).
- (b) Projects shorter than one half mile in length.
- (c) Projects with a posted speed of 35 MPH or less.
- (d) Projects with many driveways and/or cross roads with constant traffic.
- (e) District resurfacing projects.

**3. 17.3.5 Cross Slope.**

3.17.3.5.1 Cross slope will be measured once per subplot (see Table 401-4) behind the paver after final rolling of the wearing surface has taken place. Cross slope will only be evaluated when specific slopes and superelevations are shown on the plans for the entire project. Only travel lanes will be evaluated for cross slope. Measurements will be taken only in areas of normal tangent or full bank curves on even stations. Measurement shall take place utilizing one of the following methods, and shall be agreed upon by both parties: “digital read” level and 10 to 12 foot straightedge; “bubble” level, ruler, and 10 to 12 foot straightedge; transit; or electronic positioning equipment as approved by both Contractor and Department. If a straightedge is employed, perpendicularity shall be assured with the use of a right angle prism or other method acceptable to both parties. If a “bubble” or “digital read” level is employed, a second reading 180 degrees to the first shall be made and recorded, and the two shall be averaged for the test result. Measurement data shall be shared between parties within 24 hours of measurement.

3.17.3.5.2 Once a cross slope percentage has been measured, a cross slope index (CSI) will be calculated. The target cross slope shall be defined as the cross slope shown on the plans or as ordered to the nearest tenth of a percent. The CSI is the actual deviation from the target divided by 0.40 percent, which is the tolerance used for pay factor calculation only. This will allow statistical comparisons to be made among measurements based on varying specified cross slopes. The CSI will be established for the sole purpose of calculating pay factors. The CSI shall be calculated under the following equation using the specification limits in Table 401-10.

$$CSI = \frac{(M - SCS)}{T}$$

where: CSI = Cross Slope Index  
SCS = Specified Cross Slope in percent  
M = Measured Cross Slope in percent  
T = 0.40

**Table 401-10 - Acceptable Quality Level Limits**

	TARGET	LSL	USL
Cross Slope Index	0.00	-1.00	+1.00

## SECTION 401

**3.17.3.5.3** If three or more consecutive cross slope subplot measurements on the pavement lift used to calculate the pay factor deviate more than 0.5 (in percent) from the specified cross slope value at those locations, those sublots will be considered to exceed the engineering limit of 0.5%. The Contractor shall submit a corrective action plan for approval by the Engineer for cross slope sublots that exceed this limit.

**3.17.3.5.4** After the approved corrective action plan is implemented, the sublots will be measured to ensure compliance, but will not be re-measured for the purpose of re-calculating pay factor. Alternatively, the Contractor may submit a written request for acceptance of the material at a negotiated price. The Engineer will determine whether the material may remain in place at the negotiated price.

### **3.17.3.6 Rejection of Material.**

**3.17.3.6.1 An individual subplot.** For any sublots with any test results exceeding the specified reject limits, the Engineer will:

- (a) Require complete removal and replacement with hot asphalt mix meeting the Contract requirements at no additional expense to the department, or
- (b) Require corrective action to the satisfaction of the Engineer at no additional expense to the Department.

**3.17.3.6.2 A lot in progress.** The Engineer will shut down paving operations whenever:

- (a) The pay factor for any property drops below .90 and the Contractor is taking no corrective action, or
- (b) Three consecutive tests show that less than 50 percent by weight of the particles retained on the No. 4 sieve have at least one fractured face.

Paving operations shall not resume until the Engineer determines that material meeting the Contract requirements can be produced. Corrective action will be considered acceptable by the Engineer if the pay factor for the failing property increases. If it is determined that the resumption of production involves a significant change to the production process, the current lot will be terminated and a new lot will begin.

**3.17.3.6.3 Remeasure and Retest.** All requests to the Engineer to remeasure and retest a subplot shall be in writing.

### **Method of Measurement**

**4.1** Asphalt pavement mixture will be measured by the ton to the nearest 0.1 ton, and in accordance with 109.01. Batch weights will be permitted as a method of measurement only when the provisions of 3.8.3 are met, in which case, payment will be based on the cumulative weight of all the batches. The quantity will be the weight used in the accepted pavement, and no deduction will be made for the weight of asphalt binder or additives in the mixture.

**4.1.1** Hot bituminous pavement, machine or hand method (night) will be measured in the same manner as 4.1. No separate measurement will be made for lighting necessary or overtime required due to night operations at the plant or at the site.

**4.1.2** Due to possible variations in the specific gravity of the aggregates, and to possible field changes in areas to be paved, the quantity used may vary from the proposal quantities, and no adjustment in Contract unit price will be made because of such variations.

**4.2** Asphalt pavement, removed because of faulty workmanship or contamination by foreign materials, will not be included in the pay quantity.

**4.3 Blank.**

**4.4** Joint adhesive will be measured by the linear foot for each lift of pavement to be placed, to the nearest foot of adhesive applied. If the Contractor chooses to pave in echelon in lieu of using joint adhesive, payment for the length of joint eliminated by the echelon paving will be made.

**4.5** Echelon paving, when specified or approved, will be measured by the linear foot along the shared edge of the mats being simultaneously placed.

### **Basis of Payment**

**5.1** All work performed and measured as prescribed above will be paid for at the Contract unit price as provided in the respective sections for each type specified.

**5.2** Tack coat material ordered under 3.10.10 will be paid as provided for in Section 410.

**5.3 Blank.**

5.4 Plant or project site lighting for hot bituminous pavement, machine or hand method (night), or overtime required due to night operations will be subsidiary to the paving items.

5.5 Asphalt cement additives will be subsidiary to the paving items.

5.6 Implementation of the Quality Control Plan and costs associated with obtaining core samples for acceptance testing shall be subsidiary. When items are to be accepted under Quality Assurance provisions, pay adjustment will be made in accordance with 106.03.2.4 as specified below.

**5.6.1 Gradation composite pay factor (CPF).** The total price for each lot will be adjusted by a composite pay factor (CPF) based on the gradation of the material after extraction using the pay factors for each sieve size and the sieve size weight factors in Tables 401-11, 11a & 11b.

**Table 401-11 - Sieve Size Weight Factors 1"**

Property	Weight Factor "f"
1/2"	6
#30	4
Gradation (each sieve)	#8 and #200 sieves
	8
	All other sieves (each)
	2

**Table 401-11a - Sieve Size Weight Factors 3/4"**

Property	Weight Factor "f"
3/8"	6
#30	4
Gradation (each sieve)	#8, and #200 sieves
	8
	All other sieves (each)
	2

**Table 401-11b - Sieve Size Weight Factors 1/2" and 3/8"**

Property	Weight Factor "f"
No. 4	6
#30	4
Gradation (each sieve)	#8, and #200 sieves
	8
	All other sieves (each)
	2

$$\text{Composite Pay Factor (CPF)} = \frac{[f_1(PF_1) + f_2(PF_2) + \dots + f_j(PF_j)]}{\sum f}$$

**5.6.2 Pay Adjustment.** The pay adjustment for each measured characteristic will be determined by the following equation:

$$PA_j = (Pf_j - 1) \frac{f_j}{\sum f} (Q)(P)$$

where: PA = Pay adjustment payment in dollars for each characteristic.  
 Pf = Pay factor or composite pay factor for each characteristic.  
 f = Weight factor from Table 401-12 for each characteristic.  
 $\sum f$  = Sum of weight factors.  
 Q = Quantity computed from all accepted delivery records for the lot.  
 P = Contract unit price per ton.

**SECTION 401**

**Table 401-12 – Tier 1 Weight Factors**

Measured Characteristic	Weight Factor “ f”
Gradation	0.15
Asphalt Binder Content	0.15
In Place Air Voids	0.20
Thickness	0.08
Cross Slope	0.12
Ride Smoothness	0.30

**Table 401-13 – Tier 2 Weight Factors**

Measured Characteristic	Weight Factor “ f”
Gradation	0.25
Asphalt Binder Content	0.25
In Place Air Voids	0.5

**5.6.3 Pay adjustment, Hot Bituminous Pavement QC/QA Items.** The pay adjustment for gradation, cross slope, thickness, asphalt binder content, in place air voids, and ride quality (made up of the sum of all sublots) will be applied to item 1010.3. Pay adjustments may be applied at the end of each month based on all available test results for each lot.

**5.7** The accepted quantity of joint adhesive of type specified will be paid for at the Contract unit price per linear foot complete in place.

**5.7.1** Recoating of the joint, as described in 3.13.5, shall be at the Contractor’s expense.

**5.7.2** When echelon paving is used in lieu of joint adhesive and the item is not included in the contract, the accepted quantity will be paid for at the price of joint adhesive under Item 403.65.

**5.8** The Material Transfer Vehicle (MTV) Item will be paid for at the Item Bid Price per ton for the tons of bituminous mixture actually transferred by the MTV.

**5.9** The accepted quantity of echelon paving will be paid for at the Contract unit price per linear foot complete.

**5.9.1** If the Contractor chooses to pave in echelon in lieu of pavement joint adhesive, and the item is not in the contract, echelon paving will be paid as stated in 5.7.



**Appendix A**

## NHDOT Test Procedure B-7

## Sampling Bituminous Paving Mixtures For Acceptance Testing

Sample shall be taken behind the paver after placement and before compaction.

Sample location is randomly selected by the Contract Administrator.

When paving over aggregate base course or cold planed surface, use a rectangular metal plate no less than 12" each side. Center plate on sample location.

After paver passes over plate, measure back to sample location.

Locate the edges of the plate.

Using a flat-bottomed scoop large enough to obtain up to a 3000 gram sample. Place scoop on plate and push across the mat (perpendicular to the center line), through the center of the plate, filling the scoop to obtain the sample size specified below.

**Required Sample Size**

Base Courses	2000-3000 grams
Binder Courses	1500-3000 grams
Surface Courses	1000-3000 grams
Sand Courses	500-3000 grams

When sampling over an existing pavement the plate is not required.

## NHDOT Procedure B-8

## Sampling and Testing

## Procedure for In Place Air Voids

Cores will be taken at random locations selected by the Contract Administrator.

Cores will be delivered intact by the Contractor to the NHDOT inspector at the testing laboratory.

If Cores are lost or damaged, new cores shall be taken at the same location as the previous core.

Cores shall be measured for thickness following ASTM D 3549.

Bulk specific gravity shall be determined by AASHTO T 166a.

Maximum Theoretical Density will be determined using the core by AASHTO T 209.

In Place Air Voids shall be determined by AASHTO T 2.

## SECTION 403

### *SECTION 403 -- HOT BITUMINOUS PAVEMENT*

#### **Description**

**1.1** This work shall consist of constructing one or more courses of bituminous pavement on a prepared base as shown on the plans or as ordered. The methods may be classified as hand or machine.

**1.1.1** Hand method shall include only the paving of raised islands, slopes, cattle passes, areas between rails at railroad crossings, existing sidewalks, drives, drive aprons, curb patch between concrete barrier and pavement, curb patch between granite curb and pavement, and paving of 50 tons or less added after the completion of paving operations.

**1.1.2** Machine method shall include all paving not classified as hand method.

**1.2** When specified this work shall consist of constructing one or more courses of hot bituminous pavement using modifier to create higher strength.

**1.3** This work shall consist of constructing bituminous pavement under nighttime operation and will be indicated in the item description. The location shall be as shown on the plan or as ordered.

#### **Materials**

**2.1** Materials and their use shall conform to the requirements of 401.2.

**2.2** Temporary bituminous pavement shall conform to Table 401-1. Thickness shall be as shown on the plans or as ordered by the Engineer.

#### **Construction Requirements**

**3.1** Construction requirements shall be as prescribed in 401.3.

**3.2** For temporary pavement only, amend portions of 401.3.12 as follows:

**3.2.1** The requirements of 401.3.12.2.1 shall apply except rolling may be accomplished with a dual vibrating steel drum roller.

**3.2.2** Delete 401.3.12.3.

**3.3** For temporary bituminous pavement only delete 401.3.13.7.

**3.4** Temporary bituminous pavement shall be removed when no longer needed.

#### **Methods of Measurement**

**4.1** Hot bituminous pavement will be measured as prescribed in 401.4.

**4.1.1** Hot bituminous pavement, machine or hand method (night) will be measured in the same manner as 4.1. No separate measurement will be made for lighting necessary at the plant or at the site. Hot Bituminous pavement transferred by the Material Transfer Vehicle (MTV) will be measured as prescribed in 401.4.

#### **Basis of Payment**

**5.1** The accepted quantities of hot bituminous pavement will be paid for at the Item Bid Price per ton for the bituminous mixture, complete in place.

**5.1.1** The accepted quantity of hot bituminous pavement, machine or hand method (night) will be paid for at the Contract unit price per ton complete in place.

**5.1.2** No separate payment will be made for any costs of plant or project lighting, or overtime for night work needed due to night operations.

**5.2** Bridge wearing course will be paid under machine method.

**5.3** The accepted quantity of temporary bituminous pavement will be paid for at the Contract unit price per ton complete.

**5.3.1** Removal of the temporary pavement will not be paid for under other items of the Contract but will be subsidiary.

**Pay items and units:**

403.11	Hot Bituminous Pavement, Machine Method	Ton
403.119	Hot Bituminous Pavement, Machine Method, High Strength	Ton
403.12	Hot Bituminous Pavement, Hand Method	Ton
403.351	Hot Bituminous Pavement, Aggregate 35 percent Wear, Machine Method	Ton
403.352	Hot Bituminous Pavement, Aggregate 35 percent Wear, Hand Method	Ton
403.4	Material Transfer Vehicle (MTV)	Ton
403.6	Pavement Joint Adhesive	Linear Foot
403.61	Pavement Joint Adhesive (Bridge Base)	Linear Foot
403.65	Echelon Paving	Linear Foot
403.911	Hot Bituminous Bridge Pavement, 1" Base Course	Ton
403.9115	Hot Bituminous Bridge Pavement, 1" Base Course, Aggregate 50 Percent Wear	Ton
403.98	Hot Bituminous Concrete Leveling, Machine Method	Ton
403.99	Temporary Bituminous Pavement	Ton
403.XXXX1	Hot Bituminous Pavement, _____ (QC/QA Tier 1)	Ton
403.XXXX2	Hot Bituminous Pavement, _____ (QC/QA Tier 2)	Ton
403.XXX9X	Hot Bituminous Pavement, _____ (Night)	Ton
1010.3	Quality Control/Quality Assurance (QC/QA) for Asphalt	Dollar

**SECTION 410 -- BITUMINOUS SURFACE TREATMENT****Description**

**1.1** This work shall consist of preparing and applying one or more seal coats of bituminous material to a gravel or stone course. This work shall also consist of a tack coat applied to a bituminous concrete surface or a Portland cement concrete surface.

**Materials**

**2.1** Bituminous material shall be the type and grade specified or ordered and shall conform to the requirements of [Section 702](#).

**2.2** Blotter material shall be natural sand composed of hard, durable particles, free from loam, showing uniform resistance to abrasion. Gradation shall conform to [Table 520-2](#).

**Construction Requirements**

**3.1 Limitations.** Bituminous material shall not be applied on a wet surface, or when weather conditions would prevent the proper application and curing of the coat. The quantities, rate of application, temperatures, and areas to be treated shall be approved before application of bituminous material.

**3.2 Equipment.**

Equipment required for this work shall be as follows:

- (a) A distributor shall be so designed, equipped, maintained, and operated such that bituminous material at even heat may be applied uniformly on variable widths of surface up to 12 ft, at readily determined and controlled rates from 0.02 to 2.0 gal/yd<sup>2</sup>, with uniform pressure, and with an allowable variation from any specified rate not to exceed 0.02 gal. Distributor equipment shall include a tachometer, pressure gauges, accurate volume measuring devices or a calibrated tank, and a thermometer for measuring temperatures of tank contents. Distributors shall be equipped with a power unit for the pump and with full circulation spray bars adjustable laterally and vertically. The spray bar shall contain spray nozzles providing a fan-shaped spray pattern adjusted so the vertical axis is perpendicular to the pavement surface. The spray pattern and spray bar height shall be adjusted to provide a uniform application of the tack coat without double coverage. The distributor shall be equipped with a mechanical device to adjust the spray height as material is discharged to keep a uniform height above the pavement for full coverage without overlapping. The distributor shall also be equipped with a hand-held spray attachment for applying the material to areas inaccessible to spray bars and to fill in irregular areas to provide full coverage. Approved sampling valves shall be installed in distributors and transport tank trucks to permit taking representative samples of the contents. The recommended location of the sampling valve is in the rear bulkhead of the tank roughly one-third of the height above the bottom. The inlet pipe shall project into the contained liquid as shown in AASHTO T 40. At least 1 qt of material shall be drained off through the sampling valve and discarded before the desired sample is taken. New sample containers will be furnished by the Engineer. To prevent the loss of solvents, containers shall be sealed with a tight fitting cover immediately after being filled.
- (b) A rotary power broom for sweeping treated surface.
- (c) A steel-wheeled roller.
- (d) A self-propelled pneumatic-tired roller.
- (e) A sand spreader capable of spreading blotter material in sufficient quantity to prevent traffic pickup of the applied bituminous material.
- (f) A steel-brush drag of an approved type.

**3.3 Preparation of Surface to be Treated.**

**3.3.1 Tack coat.** The existing surface shall be patched and shall be free of irregularities to provide a reasonably smooth and uniform surface to receive the treatment. Unstable corrugated areas shall be removed and replaced with suitable patching materials. The edges of existing pavements that are to be adjacent to new pavement shall be cleaned to permit the adhesion of bituminous materials.

**3.4 Application of Bituminous Material.**

**3.4.1 Tack coat.** Bituminous material shall be uniformly applied with an approved applicator. When ordered, a pressure distributor shall be used. The tack coat shall be applied in such a manner as to offer the least inconvenience to traffic and to permit one-way traffic without pickup or tracking of the bituminous material.

**3.4.1.1** A tack coat shall be applied immediately prior to placement of pavement. The rate of application of emulsified asphalt shall be between 0.02 and 0.08 gal/yd<sup>2</sup>, based on the application table below. The Engineer may further modify the rate depending on the relative absorbance and texture of the pavement surface.

Existing Pavement Condition	Application Rate in Gal/yd <sup>2</sup>
New HMA	0.02 – 0.04
Oxidized HMA	0.04 – 0.06
Milled HMA	0.04 – 0.08

### 3.5 Seal Coat.

**3.5.1** When directed, a seal coat shall be applied at the rate in gallons per square yard specified on the plans or as ordered.

**3.5.1.1** Bituminous material shall be applied to the width of the section to be sealed by means of a pressure distributor in a uniform, continuous spread. When traffic is maintained, not more than one half of the width of the section shall be treated in one application. Care shall be taken that the application of bituminous material at junctions is not in excess of the specified amount. Excess material shall be squeegeed from the surface. Skipped areas or deficiencies shall be corrected.

**3.5.1.2** When traffic is maintained, one-way traffic shall be permitted on the untreated portion of the roadbed. As soon as the bituminous material has been absorbed by the surface and no longer picks up, traffic shall be transferred to the treated portion, and the remaining width of the section shall be sealed.

**3.5.2** Blotter material at the rate ordered shall be applied before the bitumen has set; the entire treated surface shall be dragged, rolled and maintained. The remaining blotter material shall be removed.

### 3.6 Finished Appearance.

**3.6.1** Any bituminous material splashed or sprayed onto exposed surfaces of curbs, sidewalks, or other masonry structures shall be removed by sandblasting at the Contractor's expense.

#### Method of Measurement

**4.1** Bituminous surface treatment will be measured by the ton, in accordance with [109.01](#), to the nearest 0.1 ton.

**4.1.1** Blotter material furnished will be subsidiary.

**4.2** Asphalt emulsion for tack coat will be measured by the gallon, in accordance with [109.01](#), to the nearest gallon.

**4.2.1** The measurement will be based on a calibrated meter mounted on the distribution vehicle or calibrated tank chart. The meter shall be calibrated at least twice per year. Measurement will be at the delivered temperature (no adjustment).

#### Basis of Payment

**5.1** The accepted quantities of bituminous surface treatment will be paid for at the Item Bid Price per ton for bituminous material, complete in place.

**5.2** The accepted quantities of asphalt emulsion for tack coat will be paid at the Item Bid price per gallon, complete in place.

**5.2.1** Emulsified asphalt for tack coat required under [401.3.10.10](#) will not be subject to price adjustment.

**5.3** Payment for patching existing pavements under 3.3.1 will be made at the contract unit price for Item 403.11 or 411.1, as ordered.

#### Pay items and units:

410.22	Asphalt Emulsion for Tack Coat	Gallon
410.31	Asphalt Surface Treatment Including Blotter Material	Ton
410.41	Emulsified Surface Treatment Including Blotter Material	Ton

**SECTION 411 -- PLANT MIX SURFACE TREATMENT****Description**

1.1 This work shall consist of a leveling course when ordered and one or more courses of bituminous mixture constructed on an existing pavement.

1.2 This work when specified shall consist of a dual purpose single course bituminous mixture which acts as a shim course and a wearing course constructed on an existing pavement.

**Materials**

2.1 Materials and their use shall conform to the requirements of 401.2 as amended below:

2.1.1 Asphalt binder PG grade to be used for a particular project will be specified in a Special Provision contained in the Proposal.

2.1.2 Unless a volumetric mix design has been performed by the Contractor, the composition of the mixtures shall conform to historical gradation and binder content. Leveling course, AC Paver Shim, Paver Spot Drag Shim, and 3/4" PMST shall be Type H unless otherwise noted.

**Table 411-1 - Composition of Mixtures - Master Ranges  
Plant Mixed Surface Treatment**

Sieve Size	Type H 3/8"		
	Percentage by Weight Passing		
	Min	Desired	Max
3/8"	95.0	100	100
No. 4	70.0	77	84.0
No. 8	54.0	59	65.0
No. 16	35.0	43	51.0
No. 30	20.0	28	36.0
No. 50	10.0	15	20.0
No. 100	5.0	8	11.0
No. 200	2.0	4	6.0
	Percentage of Total Mix		
Asphalt Cement	6.25	6.7	7.25

2.1.3 Blotter materials shall be sand conforming to the requirements of Table 411-2.

**Table 411-2 -- Blotter Material**

Sieve Size	Percent by Weight Passing
No. 4	100
No. 10	70 - 92
No. 200	0 - 6

**Construction Requirements**

3.1 Mixing plants shall be as prescribed in 401.3.1.

3.2 Mixing and storage shall conform to 401.3.1.6.11, 401.3.6, and 401.3.7 with the following modifications:

3.2.1 If the aggregate contains sufficient moisture to cause foaming in the mixture, it shall be removed from the bins. The quantity of cold aggregate fed to the dryer shall be governed by the ability of the dryer to remove the moisture completely from the aggregate, as determined by the Engineer.

3.3 Weighing and hauling shall conform to 401.3.8.

3.4 Placing shall conform to 401.3.10 with the following modifications:

**3.4.1** The existing pavement shall be thoroughly dry and free from all dust, dirt, and loose material. Sweeping with a power broom supplemented by hand brooming may be required.

**3.4.2** Existing pavement shall be treated with tack coat as prescribed in 410.3.4. When ordered, the existing pavement shall be treated as prescribed in 410.3.3.

**3.4.3** A leveling course of hot bituminous concrete may be ordered to prepare the pavement for the finish course.

**3.4.4** Any material delivered to the paver having a temperature lower than 260° F shall not be used unless modified by a qualified warm mix technology capable to being compacted to project requirements at the recommended delivery temperature.

**3.4.5** In those areas where the edges of the pavement are adjacent to paved or bituminous treated shoulders, the asphalt paving machine shall be equipped to produce a feathered edge, parallel to the direction of traffic, and a uniform longitudinal line shall be maintained at the outer edge of the applied pavement.

**3.4.6** All bridges included within the limits of the work shall be treated curb to curb.

**3.4.7** When AC Paver Shim is specified, in areas of extreme deformation of the existing roadway, some amount of dragging is expected in placing this wearing course.

**3.4.8** When Spot Drag Shims are specified, the intent is to fill and level localized ruts and deformations in the pavement. An 8' paver shall be used. Spots to be shimmed will be marked out by the Engineer. The length and widths of the spots will vary. It is expected that in most cases the pavement marking stripes will not be covered. Each spot shall be tacked before paving. Edges of shimmed areas shall be feathered by the paver. Luting or squaring up the ends of each spot will not be required.

**3.5** Compaction shall conform to 401.3.12 with the following modifications:

**3.5.1** If necessary to prevent traffic pickup of the mixture, the surface of the work shall be given a light dusting of blotter material just prior to rolling with a pneumatic-tired roller. The surface shall be maintained thereafter by occasional back sanding and rolling as directed.

**3.5.2** When more than 125 tons of mixture are being placed per hour, an additional steel-wheeled roller will be required.

**3.5.3** Excess blotter material remaining on the pavement and on paved shoulders shall be removed prior to acceptance of the project.

**3.5.4** After rolling has been completed, the edges of the pavement shall be trimmed as directed to secure a uniform line.

**3.6** The finished surface of the pavement shall be uniform in appearance, shall be free from irregularities in contour, and shall present a smooth-riding surface.

#### **Method of Measurement**

**4.1** Plant mix surface treatment will be measured as prescribed in 401.4.

**4.2** Blotter material used on plant mix surface treatment will be subsidiary.

#### **Basis of Payment**

**5.1** The accepted quantities of leveling course and plant mix surface treatment will be paid for at the Contract unit price per ton, complete in place.

**5.1.1** Tack coat material required under 3.4.2 will be subsidiary to the leveling course and plant mix surface treatment items.

#### **Pay items and units:**

411.1	Hot Bituminous Concrete Leveling Course	Ton
411.15	Hot Bituminous Concrete Leveling Course, Aggregate 50 Percent Wear	Ton
411.19	Hot Bituminous Concrete Leveling Course (Night)	Ton
411.3	Plant Mix Surface Treatment (AC), Paver Shim	Ton
411.43	Plant Mix Surface Treatment(Asphalt Cement), 3/8 in	Ton
411.46	Plant Mix Surface Treatment(Asphalt Cement), 3/4 in	Ton
411.51	Plant Mix Surface Treatment, Paver Spot Drag Shim	Ton

## SECTION 413

### **SECTION 413 -- HOT-POURED CRACK SEALANT**

#### **Description**

**1.1** This work shall consist of filling the major cracks in the pavement with an approved sealant material. The cracks to be filled will be those designated by the Engineer.

#### **Materials & Equipment**

**2.1** Material shall be of the hot-poured type and be a product as included on the [Qualified Products List](#).

**2.1.1** Material not covered by an asphalt pavement overlay shall meet the requirements of ASTM D6690 Type II.

**2.1.2** Material covered by an asphalt pavement overlay shall be low modulus conforming to ASTM D6690 Type IV except cone penetration shall be 110-150.

**2.2** Equipment shall meet the approval of the Engineer and shall be maintained in good working condition at all times.

- (a) Air compressors shall be portable and capable of furnishing not less than 100 ft<sup>3</sup> of air per minute at not less than 90 psi pressure at the nozzle. The compressor shall be equipped with traps that maintain the compressed air free from oil and water. Filters shall be inspected daily to ensure that they are still effective and not saturated with oil and moisture. Saturated and/or damaged filters shall be replaced.
- (b) Melting kettles shall be of the double-boiler, indirect-fired, portable type. The kettle shall be mounted on rubber tires and shall be equipped with a metal shield beneath the firebox to protect the pavement. The space between the inner and outer shells shall be filled with a suitable heat transfer oil or substitute having a flash point of not less than 530°F. The kettle shall be equipped with a satisfactory means for agitating the joint sealer to maintain a uniform temperature. This may be accomplished by continuous stirring with mechanically operated paddles or by a continuous circulating gear pump attached to the heating unit, or by both paddles and a pump. Kettles equipped with rocking type agitation shall not be used. The kettle shall be equipped with a thermostatic control calibrated between 200° and 550°F.
- (c) Hand pouring pots shall be equipped with mobile carriages and rubber shoes and have flow control valves that allow all cracks to be filled to refusal.
- (d) Routers for reshaping cracks shall be of the multiblade rotary cutter head type.
- (e) Hot-air lances for blowing clean and drying cracks shall be an approved propane gas burner and compressed air device that does not allow the flame to touch the pavement.
- (f) The wand applicator shall be connected to the holding tank through an applicator hose that ensures the safety of the operator and allows the operator to control the flow of material. A device shall be mounted to bypass material into the holding tank if the applicator nozzle is shut off.

#### **Construction Requirements**

**3.1** All cracks greater than 1/8" up to 3/4" in width shall be shaped with a power router to a dimension of 3/4" ±1/8" wide by 5/8" deep rectangular shape and treated unless otherwise directed. Cracks greater than 3/4" shall be treated but not routed. Router bits will be maintained to ensure that rectangular dimensions are achieved. A rounded shape will not be allowed.

**3.2** All cracks ordered treated shall be hot-air lance cleaned of dirt, foreign material, and loose edges.

**3.3** The material removed from the cracks shall be removed from the roadway surface prior to reopening the roadway to traffic.

**3.4** The hot-poured sealant shall be maintained in the kettle and applied at the temperature range specified by the manufacturer. The Contractor shall furnish the Engineer with copies of the manufacturer's literature indicating the application temperature range.

**3.5** The hot-poured sealant shall be applied to the cracks using hand pouring pots or wand applicators within 2 minutes following hot-air lance cleaning. Only wand applicators shall be used for crack filling when cracks are not covered by an asphalt pavement overlay.

**3.6** All cracks to be treated shall be filled to 1/16" to 1/8" below the pavement surface with hot-poured sealant with the sealant left slightly concave. Filling flush, overfilling, and overbanding of cracks will not be allowed. Sealant shall tightly bond to the pavement. The sealant bond to the pavement shall be checked after it has sufficiently cooled. If the sealant does not bond to the pavement, sealant shall be removed and crack sealing operations discontinued until debonding problem is corrected.

**3.7** No hot-air lance cleaning or crack sealing shall be performed when the pavement and cracks are wet or the ambient temperature is below 50°F.

**3.8** All work shall be performed in a neat manner. The sealant shall be allowed to cool sufficiently to prevent lifting, sticking, and tracking prior to returning the pavement segment to traffic.

**3.9** The contents of the kettle shall be emptied at the end of each day and shall not be reused.



**Method of Measurement**

4.1 Hot-poured crack sealant will be measured by the pound of material incorporated in the work.

**Basis of Payment**

5.1 The accepted quantity of hot-poured crack sealant will be paid for at the contract unit price per pound, complete in place.

5.2 Cleaning and routing will be subsidiary.

**Pay item and unit:**

413.1	Hot-Poured Crack Sealant	Pound
413.2	Hot-Poured Crack Sealant (Low Modulus)	Pound

**SECTION 417 -- COLD PLANING BITUMINOUS SURFACES****Description**

**1.1** This work shall consist of the removal of existing bituminous pavement, by planing or milling type equipment, to the depth and grade shown on the plans or ordered.

**1.2** This work shall consist of constructing Rumble Strips by making depressions into bituminous pavement to the depth and dimensions shown on the plans and as specified below.

**1.2.1** This work shall also consist of removing existing rumble strips and inlaying pavement in the removed area. The intent is to inlay within a short period of time after planing the existing rumble strip.

**Materials**

**2.1** The asphalt mix to inlay the removed rumble strip shall consist of a 3/8", 75 gyration N design mix.

**Construction Requirements****3.1 Equipment**

**3.1.1** Equipment used for planing of bituminous surfaces shall be a power-operated rotary planing or milling machine capable of producing a finished profile grade and cross slope to within 1/4" of the depth specified and shall produce a uniform surface texture, free from gouges and ridges, greater than 3/8". Surface tolerance will be tested with a 10-foot straight edge. The variation of the top of the ridges from the straight edge between any two ridge contact points shall not exceed 3/8".

**3.1.2** Equipment for milling new rumble strips shall consist of a rotary type cutting head with a maximum outside diameter of 24" and a length of 16" or 12". The cutting head shall have cutting tips arranged in such a pattern as to provide a relatively smooth cut (approximately 1/16" between peaks and valleys). The cutting head(s) shall be on its own independent suspension from that of the power unit to allow the tool to self-align with the slope of the shoulder and/or any irregularities in the shoulder surface. The cutting tool shall be equipped with guides to provide consistent alignment of each cut in relation to the roadway and to provide uniformity and consistency throughout the project. Equipment that tears, distorts or otherwise damages the pavement adjacent to the milled depression will not be allowed.

**3.1.3** The equipment shall be capable of accurately establishing profile grades by an automatic grade control system referencing from either the existing pavement or from an established independent grade line. The automated system shall be capable of averaging the existing grade or profile over a minimum of 30 feet, or be equipped with a sonic non-contact system with a minimum of two referencing stations mounted on the machine at a minimum length of 24 feet apart. Cross slope shall be established by an automated slope control mechanism. On projects or parts of projects where the Engineer deems that the use of automated controls are impractical, use of some or all of the controls listed above may be waived.

Vacuum trucks or street sweepers shall be used to clean the milled surfaces. Cleaning shall continue until the surfaces are free of all material which may interfere with the bond between the applied tack coat and the milled surface.

**3.1.3.1** The equipment shall have an effective means for controlling dust.

**3.2** When performing night operations, the Contractor shall provide sufficient lighting at the work site to ensure the same degree of accuracy in workmanship and conditions regarding safety as would be obtained in daylight.

**3.3 Constructing Rumble Strips.**

**3.3.1** Rumble strips shall not be constructed until 30 days after placement of new hot bituminous pavement, unless authorized by the Engineer. The depressions shall have a concave circular shape with a minimum 1/2" depth at the center and 5/8" maximum depth. Rumble strips shall be placed in the roadway according to the patterns and dimensions shown on the plans.

**3.3.2** Shoulder rumble strips shall be milled 16" in length measured perpendicular to the direction of travel.

**3.3.3** Centerline rumble strips shall be milled 12" in length, measured perpendicular to the direction of travel, or as directed in the plans.

**3.4 Removal of Rumble Strips.** Existing centerline and shoulder rumble strips scheduled for overlay shall be removed to eliminate their effects on the new pavement surface. Rumble strips shall be removed by milling a nominal depth of 1".

**3.5** Milled material not designated for salvage shall become property of the Contractor and shall be removed and disposed of in an approved manner.

**3.6** Prior to reopening the area to traffic, all equipment shall be removed to a location where it does not present a hazard to traffic and the pavement shall be cleaned by sweeping or flushing.

**3.7 Asphalt Inlay of Rumble Strip Area.** The milled area of removed rumbles shall be inlayed to match the existing pavement surface with hot bituminous pavement (placed by machine). The placement method shall be capable of spreading the mixtures with a finish that is smooth, uniform in density and texture, and free from hollows, tears, gouges, corrugations, and other irregularities.

**3.8** Compaction shall not have a specific method or compaction requirement, but shall follow the general practices of 401.3.12. Compaction efforts shall be provided by vibratory rollers having a minimum weight of three tons. Pneumatic rollers are not required.

#### **Method of Measurement**

**4.1** Cold planing bituminous surfaces, as shown on the plans or as ordered, will be measured by the square yard as determined by the actual surface measurements of the lengths and widths of the bituminous areas removed.

**4.1.1** The nominal depth of material removed will be as shown on the plans.

**4.2** Rumble strips; and remove and inlay existing rumble strips will be measured by the linear foot to the nearest one tenth of a foot.

#### **Basis of Payment**

**5.1** The accepted quantities for cold planing bituminous surfaces to the nominal depth specified will be paid for at the contract unit price per square yard.

**5.2** The accepted quantity for rumble strips; and remove and inlay existing rumble strips , will be paid for at the contract unit price per linear foot.

**5.3** Project lighting or overtime required due to night operations will be subsidiary to the cold planing.

#### **Pay item and unit:**

417.	Cold Planing Bituminous Surfaces	Square Yard
417.19	Cold Planing Bituminous Surfaces (Night)	Square Yard
417.412	Rumble Strips, 12" Wide	Linear Foot
417.416	Rumble Strips, 16" Wide	Linear Foot
417.4XX9	Rumble Strips, XX" Wide (Night)	Linear Foot
417.53	Remove and Inlay Existing Rumble Strips	Linear Foot



**DIVISION 500 – STRUCTURES*****SECTION 501 -- TEMPORARY BRIDGE*****Description**

**1.1** This work shall consist of the design, furnishing or obtaining, construction, maintenance and removal of a temporary bridge(s) and, if specified, the approaches to the temporary bridge meeting the requirements shown on the plans or contained herein. The work shall also include the design and construction of temporary abutments and piers, as required, bridge rail, connection to portable concrete barrier or temporary guardrail, and furnishing all equipment to install and dismantle the temporary bridge. The limits of the available work area shall be as indicated on the plans or as permitted.

**Materials**

**2.1** All materials to be used in the construction of the temporary bridge shall be subject to inspection and approval by the Engineer prior to their incorporation into the work. Used material will be acceptable, provided appropriate allowances are made for their condition.

**2.1.1** Steel sheet piling shall conform to Section 506.

**2.1.2** Steel bearing piles shall conform to Section 510.

**2.1.3** Concrete shall conform to Section 520.

**2.1.4** Reinforcing steel shall conform to Section 544.

**2.1.5** Structural steel shall conform to Section 550.

**2.1.6** Structural timber shall conform to Section 568.

**2.1.7** Bridge rail shall be galvanized steel conforming to Section 563.2.

**2.2** The Contractor shall provide the temporary bridge incorporating one of the following sources:

- (a) Modular Prefabricated Panel Bridge System – Contractor Supplied. Bridge components such as those manufactured by Acrow Corporation of America, Maybe Bridge, Inc., or equal subject to approval by the Department, Contractor supplied, purchased or leased under separate agreement.
- (b) Site Specific Bridge – Contractor Supplied. Bridge components, such as structural steel members with concrete or steel decking, Contractor supplied and constructed.

**Construction Requirements**

**3.1** Unless otherwise specified on the Plans, the temporary bridge, including the rail system and substructures shall meet the minimum strength requirements of an HL-93 design loading and pedestrian loading as required and specified in the AASHTO “LRFD Bridge Design Specifications”. The bridge, including superstructure, rail system, and substructures shall be designed by a Licensed Professional Engineer.

**3.1.1** Detailed plans, showing sizes, arrangement, and quality of the materials to be used in the construction and calculations of the proposed temporary bridge shall be stamped with the seal of the Licensed Professional Engineer, signed and submitted for documentation to the Engineer in accordance with 105.02. Submittals shall also include an erection plan describing the method of erection proposed and the amount and character of equipment proposed. Plans shall be documented and authorization to proceed with construction shall be obtained before construction is started. The Engineer responsible for design of the superstructure shall provide a stamped and sealed NHDOT rating form (Form 4) showing the moment and shear capacities of all structural components (such as slab, decking, girders, stringers, transoms, and/or trusses) for single lane and multiple lane loading (contact Bureau of Bridge Design (603) 271-2731 for copy of the form). The components shall be reported in HS tons using the HS-Truck portion of the HL-93 load, for multiple lane and single lane loaded conditions, load distribution, and load and resistance factors based on AASHTO Manual For Bridge Evaluation Load and Resistance Factor Rating Methods. As provided in 105.02, such documentation shall not relieve the Contractor from any responsibility under the Contract.

**3.1.2** When more than one Engineer is responsible for the design of separate components of the temporary bridge (i.e. substructure and superstructure), the Contractor shall make one submittal for documentation containing all portions of the temporary bridge unless otherwise allowed.

**3.2** The temporary bridge shall have a minimum clearspan length as shown on the plans. The minimum low steel elevation with provisions for any anticipated sag and dead load deflections shall be maintained as noted in the Contract plans.

**3.3** The temporary bridge and approaches shall be designed to accommodate the free passage of vehicles, including snowplows, for either one-way, two-way, or pedestrian traffic as specified on the Plans. The bridge shall provide for a clear width as shown on the plans.

## SECTION 501

3.4 All approach work shall be performed in accordance with the applicable specifications.

3.5 No trees shall be removed without approval.

3.6 For Modular Prefabricated Panel Bridge Systems, the Contractor shall submit, for approval, a detailed proposed sequence of erecting and dismantling of the bridge components. Plans shall be prepared by a Licensed Professional Engineer with the assistance of the manufacturer of the bridge system. Plans shall be approved before construction is started.

3.6.1 The Contractor shall have a representative from the manufacturer of the bridge system present during the erection and dismantling of the bridge components.

3.7 The Contractor shall maintain the temporary bridge until removal. The maintenance shall consist of weekly joint inspections by the Department and the Contractor as to the condition of the bridge and any repairs deemed necessary by the Engineer.

3.8 If the Contractor elects to use an alternate bridge system at any time during the Contract, the alternate bridge system shall be in place and operational before removal of the existing temporary bridge system.

3.9 When the temporary bridge and approaches are no longer required, they shall be completely removed and the area restored to its original condition or as shown on the Plans, or as directed.

### Method of Measurement

4.1 Temporary bridge and temporary bridge including approaches of the type specified will each be measured as a unit. No separate measurement will be made for multiple structures required to provide the temporary bridge as required. When more than one unit is specified in the Contract, separate item numbers will appear for each separate and complete unit.

### 4.2 Measurement of Approach Work.

4.2.1 When Item 501.1, Temporary Bridge of the type specified, is used, specific items for the approach work will appear in the Contract and measurement of these items will be in accordance with their respective sections.

4.2.2 When Item 501.2, Temporary Bridge including Approaches of the type specified, is used, all temporary bridge approach work will be included in the unit measurement.

### Basis of Payment

5.1 The accepted Temporary Bridge and Temporary Bridge including Approaches of the type specified will each be paid for at the Contract Unit price.

#### Pay items and units:

501.1	Temporary Bridge	Unit
501.11	Temporary Footbridge	Unit
501.2	Temporary Bridge including Approaches	Unit
501.21	Temporary Footbridge including Approaches	Unit

**SECTION 502 -- REMOVAL OF EXISTING BRIDGE STRUCTURE****Description**

**1.1** This work shall consist of the removal and satisfactory disposal of the existing bridge structure as shown on the plans, except such portions thereof as may be required or permitted to be left in place, or portions designated for salvage.

**Construction Requirements**

**3.1** The Contractor shall dismantle the existing structure in any manner that will not cause damage to persons or property. Removal of those portions of the existing bridge over roadways, railroads, and waterways shall be accomplished with the least possible disruption of the normal traffic flow under the bridge. Special care and precautions, including protective structures as required or ordered, shall be taken to ensure that no debris including slurry from sawcutting is allowed to fall on any roadway, railroad, or waterway.

**3.1.1** Detailed plans showing the size, arrangement and quality of materials to be used in the removal of existing bridge structures and the construction of protective structures shall be submitted for documentation in accordance with 105.02. Plans shall show the proposed method(s) of removal, all required falsework, protective structures and equipment needed to accomplish the structure removal safely.

**3.1.2 Lead-Bearing Paint.**

- (a) The Contractor is advised that the existing paint system(s) on the existing bridge may be lead-bearing paint (LBP) and contain hazardous concentrations of lead.
- (b) The Contractor shall perform construction and demolition activities (e.g. flame cutting, rivet busting, removal of bridge members, etc.) involving bridge components with LBP in conformance with the applicable worker protection provisions of OSHA 1926.62, Lead Exposure in Construction Final Rule; and LBP debris shall not be permitted to enter the environment in conformance with the environmental protection requirements of the NH Department of Environmental Services.
- (c) The Contractor shall submit a compliance plan for the removal of the existing bridge that shall include worker protection and environmental protection measures. The Contractor shall not commence with bridge removal work until receiving Department approval of the compliance plan.
- (d) Reference to these regulations shall not preclude or preempt any local, State or Federal regulations that may also apply.
- (e) The Contractor will not be held responsible for the abatement of any pre-existing conditions at the bridge site involving LBP unless directed otherwise.

**3.2** If it is specified that the existing structure, or any portion thereof, is to be salvaged, it shall be dismantled and removed in such a manner as to avoid damage to any member thereof. All structural steel members shall be marked with paint indicating member size and grade of steel.

**3.2.1** If it is specified that any part or parts of the existing structure are to be salvaged for re-erection, all members shall be match-marked with paint before they are dismantled. All pins, bolts, nuts, loose plates, and the like shall be appropriately marked for identification and be placed in durable containers. Salvaged materials shall be stored in neat piles within the limits of the right-of-way adjacent to the work or loaded onto trucks as directed.

**3.3** All parts not designated for salvage on the plans or in the special provisions shall become the property of the Contractor and shall be satisfactorily disposed of by the Contractor.

**Method of Measurement**

**4.1** This item will be measured as a unit. When more than one unit is specified in the Contract, separate item numbers will appear for each separate and complete unit.

**4.2** Limits of work shall be as established on the plans either by detail or by note. Unless otherwise shown, the horizontal limits will not exceed the neat lines of the portion of the structure to be removed.

**4.2.1** Unless otherwise shown on the plans, when the horizontal limits of bridge excavation, roadway excavation, or channel excavation fall within the specified removal limits of existing abutments, wingwalls or piers, the removal of the substructure material will be paid under the governing excavation item. Only portions of the existing bridge substructure which fall outside the horizontal limits of all other excavation items will be included as part of this item.

**Basis of Payment**

**5.1** The accepted removal of existing bridge structure will be paid for at the Contract unit price.

**5.1.1** Protective structures, if required or ordered, will be subsidiary.

**Pay item and unit:**

502.	Removal of Existing Bridge Structure	Unit
------	--------------------------------------	------

## SECTION 503

### **SECTION 503 -- COFFERDAMS AND WATER DIVERSION STRUCTURES**

#### **Description**

**1.1** This work shall consist of the design, construction, maintenance, and removal of all cofferdams, caissons, cribs, sheeting, embankments, channel diversion structures, pipes, and other similar work, including dewatering, required to allow the excavation for foundation units and to permit and protect the construction of bridge or other structural units.

#### **Materials**

- 2.1** All materials to be used in the construction of this work shall be subject to inspection and approval prior to their incorporation in the structure.
- 2.2** Sheeting specified to be left in place shall meet the requirements of [506.2](#).

#### **Construction Requirements**

##### **3.1 General.**

**3.1.1** Cofferdams and water diversion structures shall be constructed so as to protect fresh concrete against damage from a sudden rising of the stream and to prevent damage to the footings and bridge units by erosion.

**3.1.2** The Contractor shall submit drawings showing materials to be used, proposed method of construction, and other details left open to choice or not fully shown on the plans. When cofferdams are required or proposed, such information shall show the arrangement for flooding the cofferdam. Drawings shall be submitted for documentation in accordance with [105.02](#).

##### **3.2 Water Diversion Structures.**

**3.2.1** Temporary diversion channels, dikes, embankments and other similar structures shall be constructed in a way to minimize erosion and resulting water pollution. Appropriate measures of protection shall be incorporated into their construction.

**3.2.2** Pipes, sluices, elbows, etc. that are used in the diversion of water shall be of sufficient size to carry the flow specified on the plans.

**3.2.3** Temporary diversion channels, dikes and embankments shall be completely removed and restored to original or design grades as directed by the Engineer.

##### **3.3 Cofferdams.**

**3.3.1** Cofferdams or cribs for foundation construction shall be carried to adequate depths and heights, shall be safely designed and constructed, and shall be as watertight as necessary for the proper performance of the work which must be done inside them. Interior dimensions shall be such as to give sufficient clearance for the construction and exterior inspection of forms and to permit pumping outside of the forms. In no case shall the sheeting be placed inside the neat lines shown for the concrete footing or seal. No construction material shall be left in cofferdams in such a way as to extend into the substructure masonry, without permission.

**3.3.2** No excavation shall be made outside of cofferdams, nor shall the existing streambed adjacent to the structure be disturbed without the approval of the Engineer. When the Contractor is permitted to make excavation at the site of the structure before cofferdams are placed, all openings outside the cofferdams shall be backfilled with approved material to the elevations of the original ground or streambed after the cofferdams have been placed.

**3.3.3** Cofferdams which are tilted or moved laterally during the process of sinking shall be righted, reset, or enlarged, so as to provide the necessary clearance, at the Contractor's expense.

**3.3.4** Unless otherwise provided, cofferdams including all bracing shall be removed by the Contractor after the completion of the substructure, with care being taken not to disturb the surrounding soil or injure the finished masonry.

**3.3.5** Concrete foundation seals, when required or permitted, shall be constructed as provided in [Section 520](#).

##### **3.3.6 Cofferdams with sheeting left in place.**

**3.3.6.1** When called for on the plans, cofferdam sheeting shall be cut off at the top of the foundation seal or footing or at the specified elevation. The length of sheeting left in place below the specified cut off elevation will be the minimum embedment length shown on the plans or the length required on the approved cofferdam design drawings.

**3.3.6.2** Anchorage between the cofferdam sheeting and concrete foundation, if required, will be detailed on the plans.

##### **3.4 Dewatering.**

**3.4.1** Control of water within cofferdams shall be in such a manner as to prevent disturbance of the bearing soil, or fresh concrete, or segregation of backfill material. Pumping areas shall be properly filtered to prevent pumping of fines.



**3.4.2** No pumping shall be permitted during the placing of concrete or for a period of at least 24 hours thereafter, unless it is done from a suitable sump separated from the concrete work by a watertight wall.

**3.4.3** Pumping to dewater a cofferdam with a concrete foundation seal shall not commence until the seal has set sufficiently to withstand the hydrostatic pressure, and in no case before 5 days have elapsed following the placing of the concrete.

**3.4.4** Any foundation soil weakened as a result of insufficient care taken in maintaining a dewatered condition shall be removed and replaced with structural fill at the expense of the Contractor.

#### **Method of Measurement**

**4.1** The accepted quantity of water diversion structures, cofferdams, and cofferdams with sheeting left in place will each be measured as a unit. When more than one unit is specified in the Contract, separate item numbers will appear for each separate and complete unit.

#### **Basis of Payment**

**5.1** The accepted quantity of water diversion structures, cofferdams, and cofferdams with sheeting left in place will be paid for at the Contract unit price. The cost of any required anchorages shall be subsidiary.

**5.2** When no quantities for these items are included in the proposal, the work shall be subsidiary except as may be provided under 5.3.

#### **5.3 Alterations.**

**5.3.1** When the foundation is to be placed on earth, the cost of necessary alterations to the cofferdams due to required changes of more than 1 ft. in depth of the bridge excavation will be paid for as provided for in 109.04.

**5.3.2** When the foundation is to set on existing rock as prepared in accordance with 504.3.2, the cost of necessary alterations to the cofferdams when existing rock is encountered at an elevation more than 5 ft. below that anticipated at the time of the proposal will be paid for as provided for in 109.04. In cases where the plans show a sloping rock surface, no extra payment will be made unless the depth to rock is more than 5 ft. below the lowest elevation shown. When Extra Work is ordered, the cost of the first 5 ft. of additional depth of the cofferdam will not be included in the Extra Work payment. If rock is ordered removed in addition to that required by 504.3.2, the cost of any necessary alterations to the cofferdams resulting from such rock removal will be paid as provided for in 109.04.

#### **Pay items and units:**

503.1 _____	Water Diversion Structures	Unit
503.2 _____	Cofferdams	Unit
503.3 _____	Cofferdams with Sheeting Left in Place	Unit

## SECTION 504

### **SECTION 504 -- BRIDGE EXCAVATION**

#### **Description**

**1.1** This work shall consist of the excavation, satisfactory disposal, and backfill of all materials encountered in the construction of bridges as shown on the plans or ordered.

#### **Classification of Materials**

**2.1** Common bridge excavation shall consist of all materials not classified as rock. Glacial till or boulder clay will be considered as common bridge excavation.

**2.2** Rock bridge excavation shall consist of solid rock which cannot be removed without blasting or ripping. It shall also consist of boulders and parts of masonry structures when found to measure 1/2 cy or more.

#### **Construction Requirements**

##### **3.1 Preparation of a Foundation on Earth.**

**3.1.1** In areas of excavation where pumping is not required, material shall be removed and maintained a minimum of 1 ft. outside the neat lines of the footing.

**3.1.2** In areas of excavation where pumping is required, material shall be removed and maintained to such limits as will provide for carrying water outside all footing forms, with the water level maintained slightly lower than the elevation of the bottom of all footings. Suitable sumps shall be constructed and maintained.

**3.1.2.1** Where materials are encountered which are susceptible to softening or displacement when inundated, pumping shall begin prior to removal of material to grade and shall continue on a 24-hour basis until masonry has been placed.

**3.1.2.2** When blasting is required, the provisions of [203.3.2](#) and [203.3.3](#) shall apply as though contained in this Section.

**3.1.3** The final removal of the foundation material to grade shall be made in such a manner that the foundation material below grade will not be disturbed or loosened and a uniform foundation will be obtained. Removal shall be made by hand unless the use of power equipment for this purpose performs satisfactorily. This portion of the excavation shall be made in as short a time as possible before the masonry is to be placed.

**3.1.4** When ordered, a layer of structural fill of sufficient depth to stabilize the foundation material shall be applied prior to placing either forms, reinforcing steel, or masonry.

##### **3.2 Preparation of a Foundation on Rock.**

**3.2.1** Care shall be taken to avoid undue overbreakage in the drilling and blasting of rock.

**3.2.1.1** When blasting is required, the provisions [203.3.2](#) shall apply as though contained in this Section.

**3.2.2** The surfaces to receive the footings shall be level, stepped, roughened, doweled, or any combination thereof as directed. When the use of dowels is ordered, holes shall be drilled to the depth required and the dowels grouted with cement mortar conforming to [Section 707](#). The surfaces shall be cleaned and maintained clean until the masonry is placed.

**3.2.3** All loose rock and fragments shall be removed as directed.

**3.2.4** Seams shall be cleaned and grouted when ordered.

**3.3 Inspection.** After each excavation is completed, and prior to placing forms for concrete, the Contractor shall secure approval of the depth of excavation and the character of the foundation material.

##### **3.4 Backfill.**

**3.4.1** Where masonry is to rest on a rock surface, all space resulting from excavating rock within vertical planes through the neat lines of the footings shall be backfilled with concrete of the same class as that in the footings, unless otherwise shown or ordered.

**3.4.2** All spaces resulting from excavation adjacent to the structure shall be backfilled to the level of the surrounding ground with suitable material from the excavation, free from rock, lumps, wood, or other foreign matter, unless otherwise shown or ordered.

**3.4.3** Backfilling around footings shall be done immediately after form removal. Backfilling adjacent to and over arch rings or rigid frame structures shall not be performed until 21 days after the concrete has been placed, or the test cylinders prepared from the fresh concrete and cured in the laboratory have attained 80 percent of the minimum compressive strength of the class of concrete shown on the plans. Backfill material shall not exceed the optimum moisture content by more than 2 percentage points. The material shall be placed in layers not more than 12" loose depth and compacted. To avoid unequal pressures, the material shall be

placed and compacted evenly on both sides of arches and other frame type structures. All required material shall be placed in front of walls and abutments prior to beginning fills behind these structures. Unless otherwise permitted, backfilling behind bridge abutments shall be made to the elevation of the bridge seat before the structural steel is erected. Mechanical tamping or vibrating devices must be used where the use of rollers and the like are impracticable.

**3.4.4** Density requirements shall conform to 203.3.8.

**3.4.5** Adequate drainage shall be provided at all times. Water shall be used only in sufficient amounts to obtain the required compaction. Under abnormal conditions where there is no possibility of developing a liquid pressure on the structure and it is impossible or difficult to use power tamping or vibrating devices, the Engineer may order the use of water in such amounts as may be necessary to assist in placing and compacting the backfill.

**3.5 Approaches.** When the plans for a bridge or culvert structure require the construction of an approach, the fill shall be constructed in accordance with 203.3.7.

**3.6 Cofferdams.** When the work prescribed in Section 503 is subsidiary, the construction methods included in Section 503 shall apply as though contained herein.

#### **Method of Measurement**

**4.1** Common bridge excavation will not be measured, but shall be the cubic yard final pay quantity in accordance with 109.11. Rock bridge excavation will be measured by the cubic yard within the following limits:

**4.1.1** The upper limit will be the original ground except as provided under 203.5.1.6.

**4.1.2** The lateral limits shall be vertical planes, 1 ft. outside the neat lines of the footings and parallel thereto unless otherwise noted.

**4.1.2.1** When bridge excavation is required in order to place portions of the structure outside of the lateral excavation limits specified above, as may be the case in beams and cantilever walls, payment planes will be parallel to the structure, 1 ft. away from the structure, measured normally.

**4.1.3** The lower limits shall be as follows:

**4.1.3.1** When excavation for masonry that is to rest on a surface other than rock is required down to a depth of 1 ft. below the elevations shown on the plans, the material actually removed to such 1 ft. depth will be measured for payment. When such excavation is required deeper than 1 ft. below the elevations shown on the plans, the quantity of all excavation required below such limit will be paid for at 150 percent of the bid price of the appropriate bridge excavation.

**4.1.3.2** Unless otherwise shown on the plans, when masonry is to rest on existing rock either undisturbed or prepared in accordance with 3.2, the lower limit shall be either the surface of the existing undisturbed rock or the firm surface prepared in accordance with 3.2, but any rock removed below an elevation 1 ft. lower than the required elevation will be considered as excess removal and will not be measured. The quantity of any common excavation removed more than 1 ft. below the assumed elevation of the existing rock shown on the plans will be paid for at 150 percent of the bid price of the appropriate bridge excavation.

**4.1.3.3** Unless otherwise shown on the plans, when the masonry is to rest on a foundation at a plan elevation within rock, all material actually removed above a plane 1 ft. below the plan elevation will be measured for payment. When such excavation is required and ordered deeper than 1 ft. below the plan elevation, the quantity of all excavation below such limit will be paid for at 150 percent of the bid price of the appropriate bridge excavation. But any rock removed that was not ordered, below an elevation 1 ft. lower than the required elevation will be considered excess removal and will not be measured.

**4.2** Material removed from existing structures will be considered as bridge excavation if it is not to be paid for under 502, and is either:

- (a) Removed from within the volume limits noted above, or;
- (b) Is outside these volume limits and is removed within a limit of 1 ft. below the proposed slope or subgrade elevations or to such elevations as are noted on the plans or ordered.

**4.3** Blast vibration control and monitoring, preblast condition surveys, postblast surveys, blasting precautions and other protective measures will not be measured.

**4.4** When both classes (common and rock) are present in the bridge excavation the final pay quantity of common bridge excavation will be adjusted by the difference between the estimated and accepted quantity of rock bridge excavation.

#### **Basis of Payment**

**5.1** Common bridge excavation is a final pay quantity item and will be paid for at the Contract unit price per cubic yard in accordance with 109.11. The accepted quantity of rock bridge excavation will be paid for at the Contract unit price per cubic yard.

## SECTION 504

**5.1.1** No payment will be made for unauthorized material removed except that actual overbreakage of rock will be paid for, not to exceed 1 ft. below the elevations shown or ordered, within the same lateral limits specified in 4.1.2.

**5.2** Concrete necessary to replace material classified as excess removal will not be paid for; other concrete within the neat lines will be paid for under [Section 520](#).

**5.3** Payment for drilling dowel holes ordered and cleaning and grouting seams be paid as provided for in [109.04](#); the dowels will be paid for under [Section 544](#).

**5.4** Structural fill ordered under 3.1.4 will be paid for under [Section 508](#).

**5.5** When common bridge excavation is the only class included in the Contract, any rock bridge encountered will be paid for at 5 times the Contract unit price for the common bridge excavation under Item 504.2.

**5.6** The cost of all blast vibration control and monitoring, preblast condition surveys, postblast surveys, blasting precautions and other protective measures necessary to prevent damage and subsequent creation of claims in connection with blasting shall be subsidiary to Item 504.2.

### Pay items and units:

504.1	Common Bridge Excavation (F)	Cubic Yard
504.2	Rock Bridge Excavation	Cubic Yard

**SECTION 506**

***SECTION 506 -- SHEET PILING***

**Description**

**1.1** This work shall consist of furnishing and placing permanent timber or steel sheet piling as shown on the plans or ordered.

**Materials**

**2.1 Steel sheet piling.** The steel sheet piling shall conform to AASHTO M 202. Used steel sheet piling in good condition as determined by the Department is acceptable.

**Construction Requirements**

**3.1 Steel Sheet Piling.**

**3.1.1** The sections when assembled in place shall be practically watertight at the joints.

**3.1.2** The tops of the piles shall be cut off to a straight line at the elevation indicated.

**3.2 Defective piles.** The procedure incident to the driving of piles shall not subject them to excessive and undue abuse producing deformation of the steel. Manipulation of piles to force them into proper position, considered by the Engineer to be excessive, will not be permitted. Any pile damaged by reason of internal defects or by improper driving, driven out of its proper location, or driven below the elevation fixed by the plans or by the Engineer shall be corrected at the Contractor's expense.

**Method of Measurement**

**4.1** Steel sheet piling will be measured by the pound.

**4.2** Only the lengths shown on the plans or ordered will be measured.

**Basis of Payment**

**5.1** The accepted quantity of piling will be paid for at the Contract unit price per pound for steel piling, as measured.

**Pay items and units:**

506.2	Steel Sheet Piling	Pound
-------	--------------------	-------

**SECTION 508 -- STRUCTURAL FILL****Description**

1.1 This work shall consist of the formation of embankments which are intended to support structures.

**Materials**

2.1 Structural fill shall consist of crushed gravel unless bank-run gravel, clean stone fill, or other material is specified on the plans or permitted by the Engineer. When not otherwise limited the word gravel as used below will refer to both bank-run gravel and crushed gravel.

**2.1.1 Crushed Gravel for Structural Fill.****2.1.1.1 Required Grading:**

<b>Sieve Size</b>	<b>Percentage by Weight Passing</b>
3"	100
2"	95 - 100
1"	55 - 85
No. 4	27 - 52
No. 200 (Based on the fraction passing the No. 4 sieve)	0 - 12

2.1.1.2 At least 50 percent by weight of the materials retained on the 1" sieve shall have a fractured face.

2.1.2 **Bank-run Gravel for Structural Fill.** Bank-run gravel shall be graded as follows: 25 to 70 percent shall pass a No. 4 sieve. Not more than 15 percent of the portion which passes the No. 4 sieve shall pass a No. 200 sieve. No stone shall be included which cannot be incorporated in a 6" course.

**2.1.3 Clean Stone Fill for Structural Fill.****2.1.3.1 Required Grading:**

<b>Sieve Size</b>	<b>Percentage by Weight Passing</b>
2"	100
1-1/2"	95 - 100
3/4"	35 - 70
3/8"	10 - 30
No. 4	0 - 5

2.1.3.2 At least 50 percent by weight of the materials retained on the 3/4" sieve shall have a fractured face.

2.1.4 **Wear.** The percent of wear of gravel or clean stone fill shall not exceed 50 percent as determined in accordance with AASHTO T 96.

2.2 Concrete class F, flowable fill may be requested in writing as a substitute for structural fill. Approval in the form of a supplementary agreement shall be in consideration of, but not limited to, differential frost heaving due to dissimilar materials, unit weight, structural requirements, lack of permeability, and damming resulting from water flow cut off.

**Construction Requirements**

3.1 The area upon which the fill is to be constructed, regardless of the height of the proposed fill, shall be stripped of all loam, refuse, roots, stumps, boulders, and the like and shall be backfilled with the same type of material as that found at the site. All excavation shown on the plans or ordered shall be completed before constructing the fill. When fills are to be made on hillsides or when fill is built one half width at a time, the slopes of the original hillside or new fill shall be cut into or terraced as the work is brought up in layers.

3.1.1 Before the first layer of structural fill is placed, the entire work area of the original ground shall be compacted with approved compacting equipment.

3.2 Structural fill to be placed adjacent to new embankment material shall be placed concurrently with the embankment material to obtain lateral support.

**3.3** The fill shall be placed in horizontal layers of uniform thickness not exceeding 8" loose depth and compacted to the required density prior to placing the next layer. Each layer shall be compacted with power rollers, power tampers or vibratory compactors until the required density is obtained. The surface of the fill shall be kept approximately level at all times and the portion of the fill to be occupied by the structure shall be maintained at the proper density by moistening and tamping if necessary, until the concrete or structure is in place.

**3.4** The density of structural fill will be determined by AASHTO T 191 (Sand Cone Method), or by AASHTO T 310 (Nuclear Method) and shall be not less than 98 percent of the maximum density determined in accordance with AASHTO T 99 (Standard Proctor Test). This maximum density may also be determined by the control strip procedure in 304.3.8.

**3.5** The Contractor shall notify the Engineer of the anticipated date of completion of the structural fill at least 3 working days prior to completion of the fill. Upon completion, the Contractor shall not proceed with any further operations on the fill until the Engineer has taken all of the necessary proof borings. When approval has been given, the Contractor shall backfill any drilled holes with saturated sand or other approved material.

**3.6** The use of clean 1-1/2" stone fill as structural fill may be permitted by the Engineer under special circumstances, such as when dewatering problems occur during foundation construction. The total thickness of stone fill shall not exceed 12". All compaction and density requirements of this specification shall apply when using stone fill.

#### **Method of Measurement**

**4.1** Structural fill will be measured by the cubic yard as determined from the ground elevation immediately before the placement of any fill and the neat lines for the compacted material as shown on the plans.

#### **Basis of Payment**

**5.1** The accepted quantity of structural fill will be paid for at the Item Bid Price per cubic yard complete in place.

**5.1.1** Concrete class F, flowable fill substituted for structural fill will be paid for at the Contract unit price for structural fill.

**5.2** Excavation in preparation for this item will be paid for under 504 unless otherwise indicated on the plans. Any excavation for terracing and any backfilling of proof boring holes will not be measured but will be incidental to the work.

**Pay item and unit:**

508.	Structural Fill	Cubic Yard
------	-----------------	------------

**SECTION 510 -- BEARING PILES****Description**

**1.1 General.** This work shall consist of furnishing all types of bearing piles, furnishing pile driving equipment, and driving bearing piles to the required penetration, and when required, test loading, splicing, and cutting, as shown on the plans or ordered.

**Materials & Equipment****2.1 Materials**

**2.1.1** Concrete piles, precast or cast-in-place, shall be Class A unless otherwise shown on the plans and shall conform to [Section 520](#). All concrete for cast-in-place piles shall be designed with the necessary admixtures to maintain the required slump and sufficient workability throughout the entire concrete placement operation. Reinforcing steel shall conform to [Section 544](#).

**2.1.2 Steel Piles.**

**2.1.2.1** Steel H-piles shall conform to the general requirements for rolled steel plates, shapes, sheet piling and bars for structural use, ASTM A6.

**2.1.2.2** Unless otherwise specified, high-strength, low-alloy steel shall be furnished for all H-piles and conform to AASHTO M270 (ASTM A709) Grade 50 or ASTM A572 Grade 50.

**2.1.2.3** Steel pipe piles shall conform to ASTM A 252, Grade 2, unless otherwise specified.

**2.1.2.4** The use of foreign steel will be permitted only after approval by the Engineer upon suitable certification from a recognized domestic laboratory.

**2.1.3** Driving points for steel piles shall conform to AASHTO M 103, (ASTM A27) Grade 65-35 or ASTM A 148, Grade 90-60 and shall be as included on the [Qualified Products List](#).

**2.2 Equipment for Driving Piles.**

**2.2.1 Pile hammers.** Piles may be driven with steam, air, hydraulic or diesel hammers capable of driving piles at least 10 ft. longer than the longest pile length shown on the plans.

**2.2.1.1** Gravity hammers shall be subject to approval. When gravity hammers are permitted, the ram shall have a mass between 2,000 and 3,500 lb. and the height of drop shall not exceed 15 ft. In no case shall the weight of gravity hammers be less than the combined weight of drive head and pile. All gravity hammers shall be equipped with hammer guides to ensure concentric impact on the drive head.

**2.2.1.2** Open-end (single acting) diesel hammers shall be equipped with a device such as rings on the ram or a scale extending above the ram cylinder, to permit the Engineer to determine hammer stroke at all times during pile driving operations. The Contractor shall provide the Engineer a chart from the hammer manufacturer equating stroke and blows per minute for the open-end diesel hammer to be used. Closed-end (double acting) diesel hammers shall be equipped with a bounce chamber pressure gauge, in good working order, mounted near ground level so as to be easily read by the Engineer. In addition, for closed-end diesel hammers, the Contractor shall provide to the Engineer a chart calibrated to actual hammer performance within 90 days of use equating bounce chamber pressure to either equivalent energy or stroke.

**2.2.1.3** Non-impact hammers, such as vibratory hammers, or driving aids such as jets, followers, and prebored holes shall not be used unless specifically permitted in writing by the Engineer. When permitted, such equipment and driving aids shall be used only for production piles and only after the pile tip elevation necessary to provide the required ultimate resistance is established by load testing and/or test piles driven with an impact hammer. As a condition of approval of the non-impact hammers or driving aids, the Contractor shall perform, at no cost to the State, pile load tests and/or any additional work required to drive test piles, as determined by the Engineer. Installation of production piles with vibratory hammers shall be controlled according to power consumption, rate of penetration, or other means acceptable to the Engineer which assure pile load capacity equals or exceeds the test pile capacity. In addition, one of every ten piles driven with a vibratory hammer shall be retapped with an impact hammer of suitable energy to verify pile capacity.

**2.2.1.4** The plant and equipment furnished for steam and air hammers shall have sufficient capacity to maintain, under working conditions, the volume and pressure specified by the manufacturer. The plant and equipment shall be equipped with accurate pressure gauges. The weight of the striking parts of air and steam hammers shall not be less than 1/3 the weight of drive head and pile being driven, and in no case shall the striking parts have a mass less than 2,750 lb.

**2.2.2 Driving Appurtenances.**

**2.2.2.1 Hammer cushion.** All pile driving equipment shall be equipped with a suitable thickness of hammer cushion material to prevent pile damage and ensure uniform driving behavior. Hammer cushions shall be made of durable, manufactured materials, provided in accordance with the hammer manufacturer's guidelines except that all wood, wire rope, and asbestos hammer



cushions are specifically disallowed and shall not be used. A striker plate as recommended by the hammer manufacturer shall be placed on the hammer cushion to ensure uniform compression of the cushion material. The hammer cushions shall be inspected in the presence of the Engineer when beginning pile driving at each substructure element or after each 100 hours of pile driving, whichever is less. Any reduction of hammer cushion thickness shall be replaced by the Contractor before driving is permitted to continue.

**2.2.2.2 Pile cushion.** The heads of concrete piles shall be protected by a pile cushion made of plywood or other similar material approved by the Engineer. The minimum plywood thickness placed on the pile head prior to driving shall not be less than 4". A new pile cushion shall be provided for each pile. In addition, the pile cushion shall be replaced if during the driving of any pile, the cushion is either compressed more than one-half the original thickness or begins to burn. The pile cushion dimensions shall match the cross-sectional area of the pile top.

**2.2.2.3 Pile drive head.** Piles driven with impact hammers require an adequate drive head to distribute the hammer blow to the pile head. The drive head shall be axially aligned with the hammer and the pile. The drive head should be guided by the leads and not be free-swinging. The drive head should fit around the pile head in such a manner as to prevent transfer of torsional forces during driving while maintaining proper alignment of hammer and pile.

**2.2.2.3.1** For steel piling the pile heads shall be cut squarely and a drive head, as recommended by the hammer manufacturer, shall be provided to hold the axis of the pile in line with the axis of the hammer.

**2.2.2.3.2** For precast concrete and prestressed concrete piles, the pile head shall be plane and perpendicular to the longitudinal axis of the pile to prevent eccentric impacts.

**2.2.2.3.3** For special types of piles, appropriate driving heads, mandrels or other devices shall be provided in accordance with the manufacturers' recommendations so that the piles may be driven without damage.

**2.2.2.4 Leads.** Piles shall be supported in line and position with leads while being driven. Pile driver leads shall be constructed in a manner that affords freedom of movement of the hammer while maintaining alignment of the hammer and the pile to ensure concentric impact for each blow. Leads may be either fixed or swinging type. Swinging leads when used shall be fitted with a pile gate at the bottom of the leads. The pile section being driven shall not extend above the leads. The leads shall be adequately embedded in the ground or the pile constrained in a structural frame such as a template to maintain alignment. The leads shall be of sufficient length to make the use of a follower unnecessary and shall be so designed as to permit proper placing of batter piles. A free hammer and a rigid double template, which will independently support the pile, may be used when approved in writing by the Engineer.

**2.2.2.5 Followers.** Followers shall only be used when approved in writing by the Engineer, or when specifically stated in the Contract documents. In cases where a follower is permitted, the first pile in each bent and every tenth pile driven thereafter shall be driven full length without a follower to verify that adequate pile length is being attained to develop the required ultimate resistance. The follower and pile shall be held and maintained in equal and proper alignment during driving. The follower shall be of such material and dimensions to permit the piles to be driven to the length determined necessary from the driving of the full length piles. The final position and alignment of the first two piles installed with followers in each substructure unit shall be verified to be in accordance with the location tolerances in 3.6.4 before additional piles are installed.

**2.2.2.6 Jets.** Jetting shall only be permitted if approved in writing by the Engineer or when specifically stated in the Contract documents. When jetting is permitted, the Contractor shall determine the number of jets and the volume and pressure of water at the jet nozzles necessary to freely erode the material adjacent to the pile without affecting the lateral stability of the final in-place jetted pile and adjacent piles. The Contractor shall control, treat if necessary, and dispose of all jet water in a manner satisfactory to the Engineer. The Contractor shall be responsible for all damage to the site caused by unapproved or improper jetting operations. When jetting is specifically required in the Contract documents, the jetting plant shall have sufficient capacity to deliver at all times a pressure equivalent to at least 100 psi at two 3/4" jet nozzles. In either case, unless otherwise indicated, jet pipes shall be removed when the pile tip is a minimum of 5 ft. above prescribed tip elevation and the pile shall be driven to the required ultimate resistance with an impact hammer.

**2.2.2.7 Preboring.** When specified in the Contract documents, the Contractor shall prebore holes at pile locations and to the depths shown on the plans. Prebored holes shall be of a size smaller than the diameter or diagonal of the pile cross section that is sufficient to allow penetration of pile to the specified depth. If subsurface obstructions, such as boulders or rock layers are encountered, the hole diameter may be increased to the least dimension which is adequate for pile installation. Any void space remaining around any type pile after driving shall be completely filled with sand or other approved material. The use of spuds, a short strong driven member which is removed to make a hole for inserting a pile, shall not be permitted in lieu of preboring.

**2.2.3 Approval of pile driving equipment.** All pile driving equipment furnished by the Contractor shall be subject to the approval of the Engineer. All pile driving equipment shall be sized to meet the requirements in 2.2.1. Approval of pile driving equipment by the Engineer will be based on wave equation analysis and/or other judgments. In no case shall the driving equipment be transported to the project site until approval of the Engineer is received in writing. Prerequisite to such approval, the Contractor

## SECTION 510

shall submit to the Engineer the necessary pile driving equipment information at least 30 days prior to driving piles. The form for the above information is shown in Figure 1. A full size form will be included in the Contract documents or supplied by the Engineer.

**2.2.3.1 Wave equation analysis.** The criteria, which the Engineer will use to evaluate the driving equipment from the wave equation results, consist of both the required number of hammer blows per inch and the pile stresses at the ultimate pile resistance. The required number of hammer blows indicated by the wave equation at the ultimate pile resistance shall be between 3 and 15 per inch for the driving equipment to be acceptable. The pile stresses which are indicated by the wave equation to be generated by the driving equipment shall not exceed the values where pile damage impends, if the equipment is to be acceptable.

**2.2.3.1.1** The point of impending damage in steel piles is defined herein as a compressive driving stress of 90 percent of the yield point of the pile material.

For concrete piles, tensile stresses shall not exceed the following:

- 3 multiplied by the square root of the concrete compressive strength,  $f'c$ , in pounds per square inch, plus the effective prestress value, in pounds per square inch,  $3\sqrt{f'c} + \text{prestress}$ .

Compressive stresses shall not exceed 85 percent of the compressive strength minus the effective prestress value ( $0.85 f'c - \text{prestress}$ ).

These criteria will be used in evaluating wave equation results to determine acceptability of the Contractor's proposed driving system.

**2.2.3.1.2** The Contractor will be notified of the acceptance or rejection of the driving system within 14 calendar days of the Engineer's receipt of the Pile and Driving Equipment Data Form. If the wave equation analysis shows that either pile damage or inability to drive the pile with a reasonable blow count to the required ultimate resistance will result from the Contractor's proposed equipment or methods, the Contractor shall modify or replace the proposed methods or equipment until subsequent wave equation analysis indicates the piles can be reasonably driven to the required ultimate resistance, without damage. The Engineer will notify the Contractor of the acceptance or rejection of the revised driving system within 7 calendar days of receipt of a revised Pile and Driving Equipment Data Form.

**2.2.3.1.3** During pile driving operations, the Contractor shall use the approved system. No variations in the driving system will be permitted without the Engineer's written approval. Any change in the driving system will be considered only after the Contractor has submitted the necessary information for a revised wave equation analysis. The Contractor will be notified of the acceptance or rejection of the driving system changes within 7 days of the Engineer's receipt of the requested change. The time required for submission, review, and approval of a revised driving system shall not constitute the basis for a Contract time extension to the Contractor.

**2.2.3.2 Alternate approval method.** An alternate method of driving equipment approval will be used when either the Contract documents contain a provision that wave equation analysis will not be used for approval of driving equipment or the Engineer, in writing, waives the requirement for approval by wave equation analysis of pile driving equipment. The alternate approval method requires that the energy of the driving equipment submitted for approval on the Pile and Driving Equipment Data Form be rated by the manufacturer at or above the appropriate minimum energy level in Table 510-1 below corresponding to the ultimate pile resistance shown on the plans.

**2.2.3.2.1** During pile driving operations, the Contractor shall use the approved system. If the Engineer determines the Contractor's hammer is unable to transfer sufficient energy to the pile, the hammer shall be removed from service until repaired to the satisfaction of the Engineer. No variations in the driving system will be permitted without the Engineer's written approval. Any changes in the driving system will be considered only after the Contractor has submitted a new Pile and Driving Equipment Data Form. The Contractor will be notified of the acceptance or rejection of the proposed driving equipment within 7 calendar days of the Engineer's receipt of the data form.

**Table 510-1 - ALTERNATE APPROVAL METHOD**

<b>Minimum Pile Hammer Requirements</b>	
Ultimate Pile Resistance Kips	Minimum Manufacturer's Rated Hammer Energy Foot-lbs.
180 and under	9,000
181 to 300	15,000
301 to 420	20,000
421 to 540	24,000
541 to 600	26,000
601 and over	Wave Equation Required

TOWN: \_\_\_\_\_ BRIDGE NO: \_\_\_\_\_  
 STATE PROJ. NO.: \_\_\_\_\_ DESCRIPTION OF BRIDGE: \_\_\_\_\_  
 PILE DRIVING CONTRACTOR OR SUBCONTRACTOR: \_\_\_\_\_  
 (PILES DRIVEN BY)

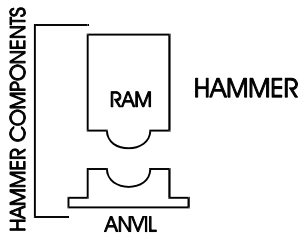

MANUFACTURER: \_\_\_\_\_ MODEL: \_\_\_\_\_  
 HAMMER TYPE: \_\_\_\_\_ SERIAL NO.: \_\_\_\_\_  
 RATED ENERGY : \_\_\_\_\_ (ft/Kps) AT \_\_\_\_\_  
 LENGTH OF STROKE: \_\_\_\_\_ (ft.) RAM WEIGHT: \_\_\_\_\_ (Kps)  
 RANGE IN OPERATING ENERGY \_\_\_\_\_ TO \_\_\_\_\_ (FOOT-KIPS)  
 RANGE IN OPERATING STROKE \_\_\_\_\_ TO \_\_\_\_\_ (FEET)  
 MODIFICATIONS: \_\_\_\_\_  
 \_\_\_\_\_  
 \_\_\_\_\_



MATERIAL: \_\_\_\_\_  
 THICKNESS: \_\_\_\_\_ (in.) AREA: \_\_\_\_\_ (in<sup>2</sup>)  
 MODULUS OF ELASICITY (E) \_\_\_\_\_ (P.S.I.)  
 COEFFICIENT OF RESTITUTION (e) \_\_\_\_\_

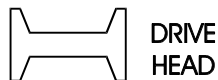

- ( HELMET
- BONNET
- ANVIL BLOCK )
- PILE CAP

WEIGHT: \_\_\_\_\_ (lbs.)



CUSHION MATERIAL: \_\_\_\_\_  
 THICKNESS: \_\_\_\_\_ (in.)  
 MODULUS OF ELASICITY (E) \_\_\_\_\_ (P.S.I.)  
 COEFFICIENT OF RESTITUTION (e) \_\_\_\_\_



PILE TYPE: \_\_\_\_\_  
 ORDERD LENGTH: \_\_\_\_\_ (ft.)  
 WEIGHT/LENGTH: \_\_\_\_\_ (lbs./ft.)  
 CROSS SECTIONAL AREA: \_\_\_\_\_ (in<sup>2</sup>)  
 PILE DESIGN LOAD: \_\_\_\_\_ (Ton)  
 DESCRIPTION OF SPLICE: \_\_\_\_\_  
 \_\_\_\_\_  
 TIP TREATMENT DESCRIPTION: \_\_\_\_\_  
 \_\_\_\_\_

**NOTE:** IF MANDREL IS USED TO DRIVE THE PILE, ATTACH SEPARATE MANUFACTURER'S DETAIL SHEET(S) INCLUDING WEIGHT AND DIMENSIONS.

SUBMITTED BY: \_\_\_\_\_ DATE: \_\_\_\_\_

**FIGURE 1 – PILE AND DRIVING EQUIPMENT DATA FORM**

## SECTION 510

### Construction Requirements

#### 3.1 General.

**3.1.1** The Contractor shall furnish the piles required after consultation with the Engineer, who will confirm or revise the lengths shown on the plans. When stated in the Contract, the actual lengths for production piles will be determined by the Engineer after the completion of pile load tests.

**3.1.1.1** The Contractor shall, at his own expense, supply increased lengths to provide for fresh heading and for such additional length as may be necessary to suit his method of operation.

**3.1.2** The length of cast-in-place piles indicated on the plans is for estimating purposes only. The actual length of piles necessary shall be established in the field by driving the shells or pipes to the required ultimate resistance and penetration.

**3.1.3** Unless otherwise permitted, bearing piles shall not be driven until the excavation or fill, whichever the case may be, has been completed. The surface area through which piles are to be driven shall be cleared of all obstructions to driving. The Contractor's attention is called to 203.3.7.6 prohibiting placing rock or other objectionable material in the fill.

**3.1.4** Individual piles and pile groups shall be installed in such sequence that the soil surrounding the pile is not compacted to the extent that other piles in the group cannot be installed properly. The installation sequence shall be such that ground movement that would damage adjacent piles, structures or utilities is prevented.

**3.1.5** All material forced up between the piles shall be removed to the correct elevation before any foundation concrete is placed.

**3.1.6** When a pile strikes an obstruction in the upper level of the penetration depth, the Engineer may order exploratory excavation or removal of the obstruction, or both. Backfill material shall be compacted to the density ordered.

#### 3.2 Piles.

**3.2.1 Precast concrete piles.** When items for furnishing and driving precast concrete piles are included in the Contract, the special provisions will specify the required methods of construction and handling.

##### 3.2.2 Cast-in-Place Concrete Piles.

**3.2.2.1 Shells.** Cast-in-place concrete piles shall be cast in metal shells which have been driven to the specified penetration and driving resistance and which shall remain permanently in place. The shells may be driven with or without a mandrel.

**3.2.2.2** The shell shall be both of watertight construction so that the concrete may be placed in the dry and of such thickness and rigidity as to show no signs of harmful distortion after being driven. The end closure shall be of adequate strength to resist driving damage and shall be tightly fastened to the shell to prevent water or soil infiltration. Neither the driving points nor the connection welds shall project more than 1/4" beyond the perimeter of the pile tips.

**3.2.2.3** Full length shells shall be used where practicable. Shells may be spliced by welding with the approval of the Engineer. All welding shall be in accordance with 550.3.6 and 550.3.16. When built up sections are required either before or during the driving operation, care shall be taken to align the section properly to ensure a straight axis for the pile. The connection shall be watertight. Built up sections during the driving operation shall be made at least 2 ft. above the ground to permit observation of the behavior of the welded connections when driving resumes.

**3.2.2.4** The cut-offs shall be made at the elevation indicated on the plans or fixed by the Engineer. After the shell has been driven, it shall be inspected and approved before any concrete is placed. Shells which have been improperly driven or are defective shall be removed and replaced, or repaired to the satisfaction of the Engineer at the Contractor's expense.

**3.2.2.5 Reinforcement.** Reinforcing steel shall be of the design shown on the plans, of the unit type rigidly fastened together and lowered into the shell before concrete is placed up to the reinforcement area. The steel shall be secured in such a manner as to ensure its proper location in the finished pile.

**3.2.2.6 Placing concrete.** All water shall be removed from shells before concrete is placed. Special care shall be taken to place the concrete so as to produce satisfactory bond with the reinforcement and avoid the formation of stone pockets, honeycomb, cold joints, or other such defects. During placing operations, the concrete in the reinforced portion of the pile shall be internally vibrated unless otherwise directed. Piles containing reinforcement shall be vibrated to at least the bottom of the reinforcement.

**3.2.2.6.1** All driving within 15 ft. of cast piles shall be discontinued for at least 7 days after the concrete has been placed or until the concrete has attained 80 percent of its desired strength.

##### 3.2.3 Steel Piles.

**3.2.3.1** Steel piles shall be of the size and shape indicated on the plans, or as directed. They shall be handled and stored in such manner as to avoid deformation or injury.

**3.2.3.2 Mill test reports.** To establish proof and ensure that the quality of the material in steel piles complies with the Contract requirements, the Contractor shall submit to the Engineer two certified copies of Heat Number Identified Mill Test Reports showing physical test results and chemical analysis. Should the Contractor be unable to furnish mill test reports as required above, the Contractor shall have a sufficient number (three minimum) of samples tested at an established metallurgical laboratory and furnish to the Engineer three certified copies of the test reports indicating that the material is in compliance with the Contract documents. Piling shall not be driven until the material has been accepted on the basis of either mill test reports or laboratory testing of samples.

**3.2.3.3 Inspection.** All piling shall be given a visual inspection at the site before driving to determine that the pile lengths contain no physical defects, such as kinks or buckles that would cause the pile to fail in driving or not perform as intended.

**3.2.3.4 Pile points.** When driving-points are used, they shall be welded to the piles in the manner recommended by the manufacturer of the points and approved by the Department. The weld joint shall be prepared for a single-bevel groove weld by beveling the edge a minimum of 1/4" at 45 degrees.

#### **3.2.3.5 Splices.**

**3.2.3.5.1** Each steel pile shall be provided in one piece without splices, unless splices are indicated on the plans, or otherwise permitted. When splicing is permitted, extensions 5 ft. or more in length at the butt end shall be used.

**3.2.3.5.2** Splices made on piles that are to be driven in pile bents, shall be made at points that will not be exposed to view, unless otherwise specifically directed or authorized by the Engineer, in which case they shall be finished to present a neat appearance.

**3.2.3.5.3** Unless otherwise directed on the plans or approved, the H-pile splice shall be a complete joint penetration groove butt weld using a 45 degree single-bevel groove weld (AWS B-U4) on the flanges and web. The weld may be made by backgouging to sound weld metal and welding the second side, or by welding from one side using a 3/16" backing bar and 1/4" root opening.

#### **3.2.3.6 Welding.**

**3.2.3.6.1** All welding shall conform to the applicable requirements of 550.3.16 - Field Welding.

**3.2.3.6.2** Welding shall only be performed by qualified welders.

**3.2.3.6.3** Welding shall be done with shielded metal arc (SMAW) using E6010 electrodes unless otherwise approved. Low hydrogen electrodes (E7018) may be used with proper storage and joint preparation. At the Contractor's option, self-shielding flux cored arc welding (FCAW-SS) may be used using E71T-6 or 8 wire for splices and E71T-11 for points.

### **3.3 Determination of Pile Driving Criteria.**

**3.3.1 Wave equation.** The wave equation analysis will be performed by the Engineer to evaluate the pile driving equipment as described in 2.2.3.1, and to establish the driving criteria that are necessary to achieve the required ultimate pile resistance. The driving criteria from the wave equation analysis may be modified during pile installation, based on the results of pile load testing as described in 3.4. Piles shall be driven with the approved driving equipment to the ordered length or other lengths necessary to obtain the required ultimate pile resistance. Jetting or other methods to facilitate pile penetration shall not be used unless specifically permitted either in the Contract documents or approved by the Engineer after revised driving criteria are established from the wave equation analysis. Adequate pile penetration shall be considered to be obtained when the specified driving criteria are achieved within 5 ft. of the tip elevation based on ordered length. Piles not achieving the specified driving criteria within these limits shall be driven to penetrations established by the Engineer.

**3.3.2 Dynamic formula.** The driving criteria to achieve the ultimate pile resistance will only be determined by dynamic formula if either the Contract documents contain a provision that dynamic formula shall be used or the Engineer approves dynamic formula use. In such case, piles shall be driven to a length necessary to obtain the ultimate pile resistance according to the following formula:

$$R_U = 1.75 (E)^{1/2} \log (10N) - 100$$

Where:

$R_U$  = the ultimate pile resistance kips

$E$  = the manufacturer's rated hammer energy ft-lb. at the ram stroke observed in the field.

$\log (10N)$  = logarithm to the base 10 of the quantity 10 multiplied by  $N$ , the number of hammer blows per inch at final penetration blows per inch.

### **3.4 Pile load tests.**

Static and/or dynamic load tests shall be performed prior to driving of other piles.

**3.4.1 Static load test.** When required, load tests shall be performed by procedures set forth in ASTM D 1143 using the quick load test method, except that the test shall be taken to plunging failure or to the test load defined in the Contract, whichever occurs

## SECTION 510

first. Testing equipment and measuring systems shall conform to ASTM D 1143. The Contractor shall submit detailed plans of the proposed loading apparatus for documentation in accordance with 105.02. The apparatus shall be constructed to allow the various increments of the load to be placed gradually without causing vibration to the test pile. When the load test requires the use of tension (anchor) piles, such tension piles shall be of the same type and diameter as the production piles and shall be driven in the location of permanent piles when feasible, except that timber or tapered piles installed in permanent locations shall not be used as tension piles. The safe pile load shall be defined as 50 percent of the failure load. The failure load for the pile shall be defined as follows: For piles 24" or less in diameter or width, the failure load of a pile tested under axial compressive load is that load which produces a settlement of the pile head equal to:

$$S_F = S + (0.15 + 0.008D)$$

Where:

$S_F$  = Settlement at failure in inches

$D$  = Pile diameter or width in inches

$S$  = Elastic deformation of total unsupported pile length in inches

For piles greater than 24" in diameter or width:

$$S_F = S + \frac{D}{30}$$

**3.4.1.1** The top elevation of the test pile shall be determined immediately after driving and again just before load testing to check for heave. All piles which heave more than 1/4" shall be redriven or jacked to the original elevation prior to testing. Unless otherwise specified in the Contract, a minimum three-day waiting period shall be observed between the driving of any anchor piles or the test pile and the commencement of the load test.

**3.4.1.2** Upon completion of the load testing, any test or anchor piling not a part of the finished structure, shall be removed or cutoff at least 1 ft. below either the bottom of footing or the finished ground elevation if not located within the footing area.

### 3.4.2 Pile dynamic load test.

**3.4.2.1** The Department will conduct pile dynamic load testing using a Pile Dynamic Analyzer (PDA) to evaluate pile capacity, hammer performance and pile stresses. PDA testing requires mounting two strain gauges and two accelerometer transducers near the pile head which are connected with cables to the PDA processing unit.

**3.4.2.2** The number of PDA tests will be determined by the Engineer. At a minimum, PDA testing will be conducted on the first 2 piles per substructure that are driven. PDA testing may also be conducted on additional piles as directed by the Engineer. This may include piles that are suspected of being damaged, or piles that do not reach expected embedment depths. The Contractor shall notify the Engineer at least 10 days prior to the start of pile driving so that arrangements can be made with the Geotechnical Section of the Materials and Research Bureau to conduct the PDA testing.

**3.4.2.3** The Contractor shall assist the Engineer as required during the PDA testing. This includes providing access while the pile is on the ground to drill the gauge mounting holes, a safe and reasonable means of access to the pile head for attaching gauges after the pile is in the leads, adequate time for installation of gauges, and any necessary support personnel, equipment or materials. A minimum 30-foot long extension ladder shall be provided in order to allow access to the pile head to mount the gauges while the pile is in the leads. It is anticipated that approximately one hour would be necessary to attach the gauges to the pile and to prepare the PDA for testing. A power supply (12 Volts DC or 110 to 125 Volts AC) and extension cords shall be provided by the Contractor for powering the PDA equipment. No payment shall be made for delays in the Contractor's operations resulting from the PDA testing and for materials, personnel or equipment provided for assisting in the PDA testing.

**3.4.2.4** The PDA will be used to evaluate both the Contractor's driving system and the driving criteria from the wave equation analysis. Based on the results of the PDA data, the Engineer may require the Contractor to modify the pile driving system if the driving operation is found to be in non-conformance with Section 510.

**3.4.3 Test piles.** Test piles shall be driven when shown on the plans at the locations and to the lengths specified by the Engineer. All test piles shall be driven with impact hammers unless specifically stated in the plans. In general, the specified length of test piles will be greater than the estimated length of production piles in order to provide for variation in soil conditions. The driving equipment used for driving test piles shall be identical to that which the Contractor proposes to use on the permanent piling and shall conform with the requirements of these specifications. The Contractor shall excavate the ground at each test pile to the elevation of the bottom of the footing before the pile is driven.

**3.4.3.1** Test piles shall be driven to a hammer blow count established by the Engineer at the estimated tip elevation.

**3.4.3.2** Test piles that do not attain the hammer blow count specified above at a depth of 1 ft. above the estimated tip elevation shown on the plans shall be allowed to "set up" for 12 to 24 hours or less if directed by the Engineer, before being redriven. A cold hammer shall not be used for redrive. The hammer shall be warmed up before driving begins by applying at least 20 blows

to another pile. If the bearing value is not attained on redriving, the Engineer may direct the Contractor to drive a portion or all of the remaining test pile length and repeat the “ set up” - redrive procedure. Test piles driven to plan grade and not having the required ultimate resistance shall be spliced and driven until the required ultimate resistance is obtained. Redriving shall be restricted to a maximum of 3” additional penetration or a maximum of 50 hammer blows.

**3.4.3.3** A record of the driving of the test piles will be prepared by the Engineer. The record will include the number of hammer blows per foot for the entire driven length, the as-driven length of test pile, the cutoff elevation, the penetration into the ground, and any other pertinent information requested by the Engineer. The Contractor shall provide the information listed in Figure 1 to the Engineer for inclusion in the record. If redrive is necessary, the Engineer will record the number of hammer blows per 1” of pile movement for the first foot of redrive. If stated in the Contract, the Contractor shall not order piling to be used in the permanent structure until test pile data have been reviewed and permanent pile lengths are authorized by the Engineer. The Engineer will provide the pile order list within 7 calendar days after completion of all test pile driving specified in the Contract documents.

### **3.5 Required Ultimate Resistance.**

**3.5.1** Piles shall be driven to the penetration shown on the plans or to a greater depth if necessary to obtain the required ultimate resistance. The driving criteria necessary to achieve the ultimate resistance will be determined by the Engineer based on methods listed in 3.3 and 3.4.

**3.5.2** The ultimate resistance of piles driven with a follower shall be considered acceptable only when the follower driven piles attain the same tip elevation as a full length pile driven without a follower, in accordance with the required driving criteria.

**3.5.3** Jetting or other methods shall not be used to facilitate pile penetration unless specifically permitted in the Contract plans or in writing by the Engineer. The ultimate pile resistance of jetted piles shall be based on impact driving blow count criteria after the jet pipes have been removed. Jetted piles not attaining the required ultimate resistance at the specified tip elevation shall be spliced if necessary at no cost to the State and driven with an impact hammer until the required driving criteria are met.

**3.5.4** The ultimate resistance of piles driven with a vibratory hammer shall be based on impact driving blow count of the first pile in each group of 10 piles. Vibrated piles not attaining the required ultimate resistance value at the ordered length shall be spliced, if necessary, at no cost to the State, and driven with an impact hammer until the required driving criteria are met. When the required ultimate pile resistance is attained, the remaining nine piles shall be installed to similar depths with similar vibratory hammer power consumption and rate of penetration as the first pile.

### **3.6 Preparation and Driving.**

**3.6.1** The heads of all piles shall be plane and perpendicular to the longitudinal axis of the pile before the drive head is attached. The heads of all concrete piles shall be protected with a pile cushion.

**3.6.2** During pile driving, the capblock and pile cushion shall be changed as described in 2.2.2 before excessive compression or damage takes place. Approval of a pile hammer relative to driving stress damage shall not relieve the Contractor of responsibility for piles damaged because of misalignment of the leads, failure of capblock or cushion material, failure of splices, malfunctioning of the pile hammer, or other improper construction methods. Piles damaged for such reasons shall be rejected and replaced at the Contractor’s expense when the Engineer determines that the damage impairs the strength of the pile.

**3.6.3 Preboring.** Spudding, auguring, wet-rotary drilling or other methods of preboring shall be used only when approved by the Engineer and in the same manner as used for any test piles. When permitted, such procedures shall be carried out in a manner which will not impair the carrying capacity of the piles already in place or the safety of existing adjacent structures.

**3.6.3.1** Except for end bearing piles, preboring shall be stopped at least 5 ft. above pile tip elevation and the pile shall be driven with an impact hammer in accordance with the driving criteria specified by the Engineer. Where piles are to be end-bearing on rock or hardpan, preboring may be carried to the surface of the rock or hardpan and the piles shall be retapped with an impact hammer to ensure proper seating.

**3.6.3.2** If the Engineer determines that pre-boring has disturbed the load bearing capacity of previously installed piles, those piles that have been disturbed shall be restored to conditions meeting the requirements of this specification by redriving or by other methods acceptable to the Engineer. Redriving or other remedial measures shall be instituted after the preboring operations in the area have been completed. The Contractor shall be responsible for the costs of any necessary remedial measures unless the preboring method was specifically included in the Contract documents and properly executed by the Contractor.

**3.6.4 Location and alignment tolerance.** The tops of piles at cut-off elevation shall be within 2” of plan locations for bent cap supported by piles and shall be within 6” of plan locations for all piles capped below final grade. Furthermore, the as-driven centroid of load of any pile group at cut-off elevation shall be within 5 percent of the plan location of the designed centroid of load. No pile shall be nearer than 4” from any edge of the cap. Any increase in size of cap to meet this edge distance requirement shall be at the Contractor’s expense.

## SECTION 510

**3.6.4.1** Piles shall be installed so that the axial alignment of the top 10 ft. of the pile is within 4 percent of specified alignment. For piles that cannot be inspected internally after installation, an alignment check shall be made before installing the last 5 ft. of pile or after installation is completed provided the exposed portion of the pile is not less than 5 ft. in length. The Engineer may require that driving be stopped in order to check the pile alignment. If the location and/or alignment tolerances specified are exceeded, the extent of overloading shall be investigated and if, in the judgment of the Engineer, corrective measures are necessary, suitable measures shall be designed and constructed by the Contractor at no cost to the State. Pulling laterally on piles to correct misalignment or splicing a properly aligned section on a misaligned section shall not be permitted.

**3.6.5 Heaved piles.** Elevation readings to check on pile heave after driving shall be made with a survey level at the start of pile driving operations and shall continue until the Engineer determines that such checking is no longer required. Level readings shall be taken immediately after the pile has been driven and again after piles within a radius of 15 ft. have been driven. The heave of shell piles shall be measured on a telltale pipe that extends to the bottom of the shell, in order to verify that the shell tip has not heaved. If pile heave is observed, accurate level readings referenced to a fixed datum shall be taken on all piles immediately after installation and periodically thereafter as adjacent piles are driven to determine the pile heave range. All piles that have been heaved more than 0.25" shall be redriven to the required resistance or penetration. Concrete shall not be placed in pile casings until pile driving has progressed beyond a radius of 15 ft. from the pile to be concreted. If pile heave is detected for pipe, shell, or tube piles which have been filled with concrete, the piles may be redriven after both the concrete has obtained sufficient strength and a proper hammer-pile cushion system satisfactory to the Engineer is used.

**3.6.6 Installation sequence.** The order of placing individual piles in pile groups shall be either starting from the center of the group and proceeding outwards in both directions or starting at the outside row and proceeding progressively across the group.

**3.6.7 Unsatisfactory piles.** The method used in driving piles shall not subject the piles to excessive or undue abuse producing crushing and spalling of concrete, injurious splitting, splintering, and brooming of the wood, or deformation of the steel. Misaligned piles shall not be forced into proper position. Any pile damaged during driving by reason of internal defects, or by improper driving, or driven out of its proper location, or driven below the designated elevation shall be corrected by the Contractor without added compensation by one of the following methods approved by the Engineer:

- (a) The pile shall be withdrawn and replaced by a new and, when necessary, longer pile. In removing piles, jets may be used in conjunction with jacks or other devices for pulling in an effort to remove the whole pile.
- (b) A second pile shall be driven adjacent to the defective pile.
- (c) The pile shall be spliced or built up as otherwise provided herein or a sufficient portion of the footing extended to properly embed the pile.
- (d) All piles pushed up by the driving of adjacent piles or by any other cause shall be retapped.

**3.6.7.1 Bent piles.** Piles which have been bent during installation shall be considered unsatisfactory unless the required ultimate resistance is proven by load tests performed at the Contractor's expense. If such tests indicate inadequate capacity, corrective measures as determined by the Engineer shall be taken, such as use of bent piles at reduced capacity, installation of additional piles, strengthening of bent piles, or replacement of bent piles.

**3.6.7.2** A concrete pile will be considered defective if a visible crack, or cracks, appear around the entire periphery of the pile, or any defect is observed which, as determined by the Engineer, affects the strength or life of the pile.

**3.7 Cutting off piles.** The tops of all piling shall be cut off square to the axis at the elevations shown on the plans or as fixed by the Engineer. Unless ownership of the pile cut-offs is released to the Contractor by the Engineer, material cut off shall be loaded by the Contractor onto vehicles as directed by the Engineer.



**Method of Measurement**

4.1 Measurement of pile items will be made in accordance with the following table.

**Methods and Units of Measurement**

<b>Item</b>	<b>Method</b>	<b>Unit</b>
Pile Driving Equipment (All equipment furnished)		Unit
Pile Loading Tests (On plans and ordered)		Each
Pile Loading Tests (Not on plans but ordered)	Extra Work	
Furnishing Precast Concrete Piles	Total quantity listed on the plans or ordered	Linear foot, to the nearest 0.1 of a 1 ft.
Driving Precast Concrete Piles	Total quantity in place	Linear foot, to the nearest 0.1 of a 1 ft.
Cast-In-Place Concrete Piles*	Total quantity in place	Linear foot, to the nearest 0.1 of a 1 ft.
Furnishing and Driving Steel Piles	Total quantity in place	Pound
Steel Pile Cut-Off**	Total quantity remaining after steel piles are in place	Pound
Pile Splices (On plans or ordered)		Each
Pile Splices (Not on plans and not ordered)	Subsidiary	
Chemical Admixture	Subsidiary	
Driving-Points for Steel Piles***		Each

\*Cut-off material from shells for cast-in-place concrete piles shall remain the property of the Contractor, and will not be measured for payment. No separate measurement will be made for reinforcing steel, excavation, drilling, cleaning of drilled holes, drilling fluids, sealing materials, concrete, required casing, and other items required to complete the work.

\*\*Steel pile cut-offs shall become the property of the Department. Extra pile lengths ordered for the purposes stated in 3.1.1.1 will not be included in this quantity.

\*\*\*No allowance will be made under furnishing or driving steel piles for the weight of driving-points.

**Basis of Payment**

5.1 The accepted quantities of bearing piles and related items will be paid for at the Item Bid Price per unit of measurement complete in place.

5.2 One-half the price bid for pile driving equipment will be paid when pile driving operations have started and the balance paid when the pile driving work has been completed.

5.3 When test piles are ordered, they will be paid for on the same basis as the other piles unless there are no other piles driven and there is no item for pile driving equipment in the proposal, in which case the test piles will be paid as provided for in 109.04, consideration being given to the cost of transporting the driving equipment to and from the site of the work.

5.4 Work ordered under 3.1.6 be paid as provided for in 109.04 except that no payment will be made for such work when the obstruction was placed there by the Contractor under the Contract.

5.5 Steel pile cut-off material will be paid for at the invoice costs plus 15 percent.

**Pay items and units:**

510.1_	Pile Driving Equipment	Unit
510.2_	Pile Loading Tests	Each
510.41_	Furnishing Precast Concrete Bearing Piles	Linear Foot
510.42_	Driving Precast Concrete Bearing Piles	Linear Foot
510.5_	Cast-in-Place Concrete Bearing Piles	Linear Foot
510.61_	Furnishing and Driving Steel Bearing Piles	Pound
510.65_	Driving-Points for Steel Bearing Piles	Each
510.9_	Pile Splices	Each

## SECTION 511

### **SECTION 511 -- PREPARATION FOR CONCRETE BRIDGE DECK REPAIRS**

#### **Description**

**1.1** This work shall consist of the preparation for repairs of concrete bridge deck including the removal of bituminous materials, the removal of unsound concrete from the existing deck to assure proper repair, and the disposal of all materials removed.

#### **Equipment**

**2.1** The equipment used for pavement and concrete removal shall be subject to approval of the Engineer and shall comply with the following:

##### **2.1.1 Bituminous pavement removal.**

**2.1.1.1** The pavement removal may be performed with planers, backhoes, loaders, or other approved mechanical equipment.

##### **2.1.2 Bridge deck concrete overlay.**

**2.1.2.1** Scarifying equipment shall be either a power operated rotary scarifier or a high-pressure waterjet scarifier capable of uniformly scarifying the existing surface to the depth required in a satisfactory manner. Scarifying equipment shall be fully automated. Power operated rotary scarifier shall be equipped with a short ski, shoe or a similar device attached to the cutter head to limit the depth of cut. The use of multiple impact or vibratory equipment will not be allowed.

**2.1.2.2** Sand or water blasting equipment shall be capable of removing rust and loose concrete from the exposed reinforcement and concrete surface.

##### **2.1.3 Bridge deck concrete partial or full depth repairs.**

**2.1.3.1** Sawing equipment shall be capable of cutting concrete to the specified depth.

**2.1.3.2** Power driven hand tools for concrete removal will be permitted with the following restrictions:

- (a) Jackhammers heavier than nominal 30 lb. class shall not be used.
- (b) Jackhammers or mechanical chipping tools shall not be operated at an angle in excess of 45 degrees measured from the surface of the deck.
- (c) Chipping hammers heavier than nominal 15 lb. class shall not be used to remove concrete from beneath any reinforcing bar.
- (d) Hand tools, such as hammers and chisels, shall be used for removal of final particles of unsound concrete or to achieve the required depth of removal.

**2.1.3.3** High-pressure waterjet equipment, either hand held or remote controlled, will be permitted for concrete removal.

#### **Construction Requirements**

**3.1** Concrete and pavement shall be removed from each area as shown on the plans or required. Removal areas as shown are based on Department studies; actual removal areas will be determined by the Engineer. The various classes of removal shall be accomplished according to the following requirements.

**3.1.1** When preparation for bridge deck concrete overlay is not specified, the concrete bridge deck pavement removal shall be accomplished with equipment capable of removing the existing bituminous pavement and membrane waterproofing without damaging the top surface of the deck concrete. The preparation of the deck surface prior to placement of new barrier membrane shall include removal of all existing membrane waterproofing and any membrane primer which is not tightly adhered to sound concrete. The Engineer may order sand blasting of a test area of primer to determine its acceptability for leaving in place. Additional preparation of the deck surface shall be as recommended by the manufacturer of the new barrier membrane to be applied.

**3.1.2** When preparation for bridge deck concrete overlay is specified, the entire existing concrete deck area shall be uniformly scarified to a minimum depth of 1/4" or as specified on the plans. Removal to a greater depth will be required adjacent to scuppers and expansion joints and elsewhere, as shown on the plans or ordered. All full and partial depth repairs shall be performed prior to the scarification of the entire deck, unless otherwise permitted.

**3.1.3** When removal for partial or full depth repairs is specified, the concrete may be removed by chipping or by a combination of scarifying and chipping, except that final chipping, in any case, shall be by use of hand tools. The entire periphery of the partial or full depth removal areas shall be saw cut to a minimum depth of 1". or to the top of the upper reinforcing steel. Care shall be taken to avoid cutting into any reinforcing bars. Care shall be exercised to prevent stretching or damaging exposed reinforcing steel.

**3.1.3.1** Partial depth removal for all concrete within the periphery of the designated removal area shall extend at least to 3/4" below the lower bars of the top reinforcing steel mat, or deeper as required to remove all unsound concrete. The Engineer may

require enlargement of a designated partial removal area should inspection reveal deterioration of concrete or corrosion of the reinforcing beyond the limits originally designated. In designated areas of partial depth removal where less than one half the designed deck thickness remains, all concrete shall be removed. Designated partial depth removal areas which become full depth removal shall be treated as full depth removal areas in accordance with 3.1.3.2. Limited areas of partial depth removal greater than half the slab thickness (such as beneath reinforcing) may be allowed by the Engineer. These limited areas of excess partial depth will be treated as partial depth removal.

**3.1.3.2** Full depth removal shall consist of removing all concrete for the full depth of the bridge deck. The lateral limits of this removal shall be to sound existing concrete, as determined by the Engineer. Areas where unsound concrete exists on the bottom surface of the deck shall be repaired by full depth removal even if the concrete directly above the unsound concrete is sound.

**3.1.3.2.1** Full depth concrete removal on those portions of the bridge deck over roadways, railroads or waterways shall be accomplished with the least possible disruption of the normal traffic flow under the deck. Special care and precautions, including protective structures as required or ordered, shall be taken to ensure that no debris is allowed to fall on any roadway, railroad, or waterway. All preparation work shall be carried out so as to prevent damage to those portions of the bridge that are to remain.

**3.2** The thickness of any new concrete above the prepared surface or reinforcing steel shall be at least 3/4" and may be greater as shown on the plans. This clearance shall be checked according to the following:

**3.2.1** A filler block having a thickness of 1/8" less than the required concrete thickness shall be attached to the bottom of the screed or an approved template, which shall then be passed over the area to be concreted. All old concrete which does not have sufficient clearance shall be removed. All reinforcing steel which does not have sufficient clearance shall be depressed. It may be necessary to remove concrete beneath some reinforcement to permit depressing the reinforcement adequately. Hand tools shall be used to remove final portions of concrete to achieve the required depth.

**3.3** Any slurry produced by wet sawing shall be thoroughly flushed from the concrete surface by a jet of water, and puddles of water shall be removed with an oil-free air blast before the start of any patching or overlay operations.

**3.4** All surfaces of existing concrete including any previously placed concrete to be in contact with the new concrete shall be thoroughly cleaned by sandblasting or high-pressure water-blasting.

**3.5** Reinforcing steel or other steel to be in contact with the new concrete shall be cleaned of all grease, dirt, concrete mortar and injurious rust. Injurious rust shall be interpreted to mean rust which is not firmly bonded to the steel. Rust which is difficult to remove by vigorous scrubbing with a wire brush shall be considered firmly bonded to the steel.

**3.6** Any portions of granite curb and mortar against which new concrete is to be placed shall be blast cleaned. Loose granite curb shall be reset in accordance with [Section 609](#). Any deteriorated curb mortar bed shall be removed and replaced.

**3.7** After sandblasting or water-blasting and just prior to applying the bonding agent or grout in preparation for placement of the new concrete, all surfaces which will be in contact with new concrete shall be vacuum-cleaned or air-blown. A combination of vacuum cleaning and air-blowing may be required.

**3.8** After the bridge deck has undergone removal of old concrete and before new concrete has been placed and cured, construction loads shall not be permitted which exceed either an 8,000 lb. wheel load or a 16,000 lb. axle load. Any combination of axles spaced closer than 4 ft. center-to-center shall be considered as one axle. Placement of construction loads on the removal area shall be subject to approval of the Engineer.

#### **Method of Measurement**

**4.1** Concrete bridge deck pavement removal and preparation for concrete bridge deck overlay will not be measured, but shall be the square yard final pay quantity in accordance with [109.11](#) for the area within the limits shown on the plans.

**4.2** Preparation for partial depth concrete bridge deck repairs and preparation for full depth concrete bridge deck repairs will be measured by the square yard to the nearest 0.1 of a square yard.

**4.2.1** Preparation for partial depth concrete bridge deck repairs and preparation for full depth concrete bridge deck repairs may be measured within the same areas as preparation for concrete bridge deck overlay with no reduction in the pay quantity of Item 511.01.

**4.2.2** Partial depth removal areas which become full depth removal areas will be measured as Item 511.03.

## SECTION 511

### Basis of Payment

5.1 Concrete bridge deck pavement removal and preparation for concrete bridge deck overlay are final pay quantity items and will be paid for at the Contract unit price per square yard in accordance with 109.11.

5.1.1 The removal of bituminous materials on the roadway approaches will be paid for under Section 417.

5.1.2 Protective structures if required will be subsidiary to Item 511.03.

### Pay items and units:

511.00	Concrete Bridge Deck Pavement Removal (F)	Square Yard
511.01	Preparation for Concrete Bridge Deck Overlay (F)	Square Yard
511.02	Preparation for Partial Depth Concrete Bridge Deck Repairs	Square Yard
511.03	Preparation for Full Depth Concrete Bridge Deck Repairs	Square Yard

**SECTION 512 -- PREPARATION FOR CONCRETE REPAIRS****Description**

**1.1** This work shall consist of inspecting and preparing existing deteriorated concrete surfaces for repairs at the locations shown on the plans and as directed by the Engineer. Since a significant portion of the work may involve discovering and repairing hidden deteriorated concrete, the Contractor should carefully inspect the work area before bidding.

**Construction Requirements**

**3.1** Scaffolds shall be furnished and erected at those locations where necessary to perform inspection, preparation and repair work.

**3.2** Cleaning the concrete in preparation for the repairs shall include the following work as required and directed:

**3.2.1** Visually examining and testing the concrete surface by sounding with a hammer to detect hidden deterioration which is indicated by a hollow sound when struck. While work is in progress, the Contractor and Engineer shall jointly inspect and sound the concrete areas to be repaired to determine the limits of the work.

**3.2.2** Removing deteriorated concrete to a sound concrete surface free of laitance, dirt, or other foreign material shall be done by power brushing, the use of jackhammers where their use is allowed, sawing, sandblasting, water blasting, mechanical abrading, hosing with water, air-blast cleaning, or other approved methods. If reinforcing steel is exposed when removing concrete to a sound surface, or if exposure of the reinforcing steel in prepared areas is required by the plans, the minimum depth of removal shall be 1-1/2" behind the main reinforcing steel. If reinforcing steel is not exposed when removing concrete to a sound surface, and if exposure of the reinforcing steel in prepared areas is not required by the plans, the minimum depth of removal shall be 1/2" plus the maximum coarse aggregate size of the patching material.

**3.2.3** The edges of all prepared areas shall be saw cut to a minimum depth of 1/2" plus the maximum coarse aggregate size of the patching material. On vertical surfaces, if forms are to be used, the shape of the areas to be patched shall be such that the entire area to be patched is easily accessible, as determined by the Engineer. Although an occasional distribution or tie reinforcing bar may be cut, main reinforcing steel shall not be saw cut except as shown on the plans.

**3.2.4** Reinforcing steel or other steel to be in contact with the new concrete shall be cleaned of all grease, dirt, concrete mortar and injurious rust. Injurious rust shall be interpreted to mean rust which is not firmly bonded to the steel. Rust which is difficult to remove by vigorous scrubbing with a wire brush shall be considered firmly bonded to the steel.

**Method of Measurement**

**4.1** Preparation for concrete repairs will be measured by the square yard to the nearest 0.1 of a square yard as determined by actual surface measurements of the lengths and widths of all the surfaces prepared.

**4.2** Areas prepared to a sound surface without exposing reinforcing steel will be measured as Class I preparation areas. Areas prepared to a sound surface a minimum of 1-1/2" behind the reinforcing steel will be measured as Class II preparation areas.

**Basis of Payment**

**5.1** The accepted quantity of preparation for concrete repairs will be paid for at the Contract unit price per square yard complete.

**Pay items and units:**

512.01	Preparation for Concrete Repairs, Class I	Square Yard
512.02	Preparation for Concrete Repairs, Class II	Square Yard

**SECTION 520 -- PORTLAND CEMENT CONCRETE****Description**

**1.1 General.** This work shall consist of furnishing and placing Portland cement concrete of the classes specified including fly-ash, silica fume, or ground granulated blast furnace slag as shown on the plans or as ordered.

**1.1.1** The work also consists of furnishing, placing, and curing structural Portland cement concrete as shown on the plans or as ordered, to be accepted under Quality Assurance (QA) provisions.

**1.2 Classes of concrete.** The following classes of concrete are included in these specifications Table 520-1A - Method and Table 520-1B - Performance (QC/QA).

**Table 520-1A - Classes of Concrete**

Concrete Class	Minimum Expected 28 Day Compressive Strength <sup>1</sup>	Maximum Water/Cement Ratio <sup>2</sup>	Entrained Air Percent	Permeability Target Value <sup>6</sup>
	PSI			kΩ-cm
AAA <sup>3</sup>	5,000	0.400	5 to 9	20
AAA	5,000	0.444	5 to 9	
AA <sup>3</sup>	4,000	0.400	5 to 9	20
AA	4,000	0.444	5 to 9	20
A	3,000	0.464	4 to 7	10
B	3,000	0.488	3 to 6	
T	3,000	0.559	----	
F	30 <sup>4</sup>	3.0 to 4.0 <sup>5</sup>	15 to 25 <sup>5</sup>	

**Table 420-1B - Class of Concrete – Performance Requirements (QC/QA)**

Concrete Class	Minimum Expected 28 Day Compressive Strength	Permeability	Air Content		Water/Cement Ratio		Concrete Cover
			LSL	USL	LSL	USL	
	PSI	kΩ	Percent		Percent		Inch
		Minimum	LSL	USL	LSL	USL	TV ± T
AA	4,000	5	5.0	9.0	Mean - 0.030	Mean + 0.030	1/2 (T = ± 12)
A	3,000	5	4.0	----	----	----	----
B	3,000	-----	3.0	----	----	----	----

LSL - lower specification limit

USL - upper specification limit

Mean - calculated mean of all test results for a lot.

TV - Target Value<sup>1</sup>

T - Tolerance

<sup>1</sup> Target value is defined as the typical clearance as shown on the plans or as ordered by the Engineer, for each location to be evaluated.

**1.2.1** Unless otherwise shown on the plans, the specified class of concrete shall be used in the following applications.

**1.2.1.1 Method Requirements.**

- Footing concrete shall be Class B.
- Concrete above footings shall be Class A.
- Abutment backwall concrete shall be Class AA.

- (d) Concrete bridge decks shall be Class AA.
- (e) Concrete foundation seals shall be Class T.
- (f) Class F, Flowable Fill, Excavatable may be specified or requested in writing as a substitute for compacted gravel in embankment, granular backfill, structural fill, and pipe backfill. Approval in the form of a supplementary agreement shall be in consideration of, but not limited to, differential frost heaving due to dissimilar materials, unit weight structural requirements, lack of permeability, and damming resulting from water flow cut off. Flowable fill will not be allowed in lieu of pavement. Class F, Flowable Fill shall be a flowable, self-consolidating, rigid setting and low density material.
- (g) Precast concrete shall be Class AAA.

#### 1.2.1.2 Performance Requirements (QC/QA).

- (a) Footing concrete shall be Class B.
- (b) Substructure concrete above footings shall be Class A except as shown in (c) and (d) below.
- (c) At-grade approach slab concrete shall meet the requirements of and be paid as QC/QA Concrete Class AA, Item 520.0302X Concrete Class AA Approach Slabs (QC/QA)(F).
- (d) Concrete bridge decks, copings, bridge sidewalks, abutment backwalls, and wing copings, shall meet the requirements of and be paid as QC/QA Concrete Class AA, Item 520.7X02 Concrete Bridge Deck (QC/QA)(F).
- (e) Concrete in rail support slabs shall meet the requirements of, and be paid as, QC/QA Concrete Class AA, Item 520.0202X Concrete Class AA, Rail Support Slab (QC/QA)(F).
- (f) Class F, Flowable Fill, Excavatable may be specified or requested in writing as a substitute for compacted gravel in embankment, granular backfill, structural fill, and pipe backfill. Approval in the form of a supplementary agreement shall be in consideration of, but not limited to, differential frost heaving due to dissimilar materials, unit weight structural requirements, lack of permeability, and damming resulting from water flow cut off. Flowable fill will not be allowed in lieu of pavement. Class F, Flowable Fill shall be a flowable, self-consolidating, rigid setting and low density material.
- (g) Precast concrete shall be Class AAA.

**1.2.2** Retarding admixtures and Type G high range water reducing (HRWR) admixtures shall not be used in deck concrete when the existing air temperature is below 50° F or forecasted to drop below 50° F within 24 hours after completion of placement.

### Materials

#### 2.1 Cement.

**2.1.1** Portland cement shall be Type II, or Type IP conforming to AASHTO M 85 or M 240 as appropriate, unless otherwise shown on the plans or permitted. Mill test reports shall be furnished with each delivery of cement.

**2.1.2** Cement used in visible portions of the work shall be the same brand, type, and color unless otherwise permitted.

**2.1.3** Cement containing lumps or partial set shall not be used.

#### 2.1.4 Supplemental Cementitious Materials

##### 2.1.4.1 Fly-Ash and Ground Granulated Blast Furnace Slag.

**2.1.4.1.1** Fly-ash shall conform to Class C or Class F as described in AASHTO M 295 and shall meet the requirements of 2.1.4.1.3. Ground Granulated Blast Furnace Slag (GGBFS) shall be Grade 120 or Grade 100 slag meeting the requirements of AASHTO M 302.

**2.1.4.1.2** Only one source of fly-ash or ground granulated blast furnace slag shall be used on any one project.

**2.1.4.1.3 Requirements.** Fly-ash shall conform to the chemical, physical and methods of sampling and testing requirements of AASHTO M 295 except that the CaO content shall be 8% or less and in the optional physical requirement, the multiple factor shall be 120 percent maximum. In addition, the fly-ash shall be subjected to the Air-Entrainment of Mortar Test as listed in ASTM C 311 and shall conform to the requirements as listed in the optional physical requirements of AASHTO M 295 for the uniformity requirements. Ground granulated blast furnace slag shall be Grade 120 or Grade 100 conforming to the chemical, physical, and methods of sampling and testing requirements of Ground Iron Blast Furnace Slag for Use In Concrete and Mortars as listed in AASHTO M 302.

**2.1.4.1.4 Certification.** The Contractor shall furnish the Department three copies of the materials test results and certification from each fly-ash or ground granulated blast furnace slag source proposed for use. The certification shall state the fly-ash or ground granulated blast furnace slag used on the project meets the requirement as stated in 2.1.4.1.3 and shall be for a specific, identifiable quantity.

**2.1.4.1.5** Fly-ash produced from a particular source shall be tested by the Contractor for loss on ignition and fineness at the frequency of one test per 100 tons used. Complete testing of fly-ash shall be done by the Contractor at a frequency of one test per 400 tons of fly-ash used or as directed by the Department.

## SECTION 520

**2.1.4.1.6** Under the direction of the Department, fly-ash or ground granulated blast furnace slag shall be sampled by approved means and shall be placed into a sealed container.

### 2.2 Aggregates.

#### 2.2.1 General.

**2.2.1.1** All aggregates shall be thoroughly washed unless otherwise permitted. Aggregates shall be stockpiled for a minimum of 24 hours before use.

**2.2.1.2** The Contractor shall make arrangements for the Engineer to secure samples from all stockpiles in sufficient time to complete testing prior to starting concrete operations. If the stockpiled aggregates are approved, similar aggregates from the same sources will be considered acceptable, subject to the restrictions of the item for which the aggregates are to be used. No change in the source or character of the aggregates shall be made without prior notification to and approval by the Bureau of Materials and Research. Failure of any test taken prior to starting each placement will result in cancellation of the placement until corrective measures have been taken and the aggregates have been approved.

**2.2.1.3** Unless frozen aggregates are dispersed during mixing, they shall not be permitted.

#### 2.2.2 Method Requirements.

##### 2.2.2.1 Fine Aggregate.

**2.2.2.1.1** Fine aggregate shall consist of sand, stone screenings, or other inert materials with similar characteristics, or a combination thereof. Tests for organic impurities shall be in accordance with AASHTO T 21 and T 71.

##### 2.2.2.1.2 Required grading:

<b>Sieve Size</b>	<b>Percentage by Weight Passing</b>
3/8"	100
No. 4	95 – 100
No. 8	80 - 100
No. 16	50 – 85
No. 30	25 - 60
No. 50	10 – 30
No. 100	2 – 10
No. 200	0 – 3

**2.2.2.1.2.1** The gradation of fine aggregate from any source shall be reasonably uniform and the fineness modulus as determined by AASHTO M 6 shall lie between 2.3 and 3.1. Fine aggregate showing a variation in fineness modulus greater than 0.2 above or below that upon which the mix was designed may be rejected.

**2.2.2.1.3** The requirements of 2.2.2.1.2 will not apply to fine aggregate for concrete class F, flowable fill. For concrete class F the fine aggregate grading shall be submitted with the mix design.

##### 2.2.2.2 Coarse Aggregate.

**2.2.2.2.1** Coarse aggregate shall consist of crushed stone, gravel, or other approved inert materials with similar characteristics or combinations thereof, having hard, strong, durable particles, free from surface coating and injurious amounts of soft, friable, or laminated pieces, and free of alkaline, organic, or other harmful matter. Material passing the No. 200 sieve as determined by AASHTO T 11 shall not exceed 1.0 percent by weight. Thin or elongated particles shall not exceed 10 percent by number as determined by ASTM D 4791, on a 3 to 1 ratio and a minimum of 100 particles. The percent of wear shall not exceed 40 as determined by AASHTO T 96.



**2.2.2.2.2 Required grading:****Table 520-3 - Coarse Aggregate**

Class of Concrete:	A <sup>1</sup> , B, and T	A, AA, and AAA	Overlay
Standard Stone Size:	467	67	89
Nominal Size:	1 -1/2" to No. 4	3/4" to No. 4	3/8" to No. 16
SIEVE SIZE	PERCENTAGE BY WEIGHT PASSING		
2"	100		
1- 1/2"	95 - 100		
1"		100	
3/4"	35 - 70	90 - 100	
1/2"			100
3/8"	10 - 30	20 - 55	90 - 100
No. 4	0 - 5	0 - 10	20 - 55
No. 8		0 - 5	5 - 30
No. 16			0 - 10
No. 50			0 - 5

<sup>1</sup> 1-1/2" maximum size coarse aggregate for Class A concrete may only be used with approval of the Bureau of Materials and Research.

**2.2.2.2.3** Unless otherwise specifically permitted, coarse aggregate shall be furnished and stockpiled in a minimum of 2 sizes and the amount of each size to be used shall be determined by combining the individual gradations of each stockpile mathematically to provide a well graded mixture conforming to Table 520-3.

**2.2.3 Performance Requirements (QC/QA).**

**2.2.3.1** Follow general requirements for aggregate section 2.2.1.

**2.3 Chemical Admixtures.**

**2.3.1** Chemical admixtures shall be products as included on the [Qualified Products List](#).

**2.3.2** Air-entraining admixtures shall meet the requirements of AASHTO M 154. If the Contractor requests permission to use an unfamiliar air-entraining admixture, evidence shall be submitted to prove that the admixture complies with AASHTO M 154. The evidence shall be based on tests performed in a laboratory of a state transportation department, the FHWA, or in a laboratory which is regularly inspected by the Cement and Concrete Reference Laboratory of the National Bureau of Standards. Tests may be made on samples taken from a quantity submitted and certified by the manufacturer as representative of the admixture to be supplied.

**2.3.2.1** When using high range water reducing admixture the air entrainment admixture shall be a Vinsol Resin or approved equal conforming to AASHTO M 154.

**2.3.3** Water-reducing admixtures shall meet the requirements of AASHTO M 194, Type A.

**2.3.3.1** Water-reducing, high-range admixtures shall conform to AASHTO M 194 Type F or Type G.

**2.3.3.2** Corrosion inhibitor admixtures shall conform to ASTM C 1582.

**2.3.4** Water-reducing and retarding admixtures (herein referred to as retarding admixtures) shall meet the requirements of AASHTO M 194, Type D.

**2.3.5** Calcium chloride may only be used with specific permission of the Bureau of Materials and Research.

**2.3.6** Admixtures shall be stored in a suitable building in such a manner as to permit easy access and identification and to protect the admixtures from freezing. Admixtures will be rejected if precipitation has occurred in the container.

**2.3.7** Silica Fume shall conform to AASHTO M307, Microsilica for use in Concrete and Mortar.

**2.3.7.1** Bags used to supply silica fume shall not be incorporated into the concrete.

**2.4 Blank.****2.5 Water.**

**2.5.1** Water for use in concrete shall be free from oils, acids, organic matter or other deleterious substances and shall not contain more than 500 parts per million of chlorides as Cl nor more than 1000 parts per million of sulfates as SO<sub>4</sub>. In addition

## SECTION 520

water used in Portland cement concrete shall be free from iron, tannic acid, and other impurities which may cause staining or discoloration.

Water from municipal supplies approved by the State of New Hampshire Department of Environmental Services will not require testing, but water from other sources will be sampled and tested before being used in concrete, once per source unless otherwise directed. Tests shall be made in accordance with AASHTO T 26. A sample of approximately 1 gallon will be obtained by Department personnel.

The hydrogen ion concentration (pH) shall be determined electrometrically or colorimetrically and be between pH 4.5 and pH 8.5.

The water shall not contain any impurities in amounts sufficient to cause unsoundness or marked change in the time of setting in the cement with which it is mixed, nor a reduction in mortar strength of more than 10 percent compared to the results obtained with distilled water.

### 2.6 Curing Materials for Concrete.

**2.6.1** Burlap shall conform to AASHTO M 182. The use of worn burlap, burlap with holes, or burlap reclaimed from uses other than curing concrete will not be permitted.

**2.6.2** Sheet materials shall be waterproof paper, polyethylene film, or white burlap-polyethylene sheeting conforming to AASHTO M 171.

**2.6.3** Liquid curing compound shall be a product as included on the [Qualified Products List](#). Resin or wax based curing compounds shall not be used on concrete where water repellants are to be applied. Pigmented curing compounds shall not be used on surfaces that are to be membraned.

**2.6.3.1** Liquid curing compound shall be Type ID (fugitive dye), Class B or Type 2 (white pigmented), Class B conforming to AASHTO M 148 except as modified herein. The vehicle shall have a resin base and contain no waxy compounds. The compound shall dry to touch within 4 hours when applied at the rate of 1 gallon per 200 square feet of concrete.

**2.6.4** Cotton mats shall consist of a filling material of cotton “batting” 12 oz/square yard; covered with unsized cloth 6 oz/Square Yard; tufted or stitched to maintain stability. Mats shall be free from tears and shall be in good condition.

**2.6.5** Water for curing shall meet the requirements of 2.5 above.

### 2.7 Preformed expansion joint fillers.

Preformed expansion joint fillers for concrete shall conform to AASHTO M 153, Type II, unless Type III is shown on the plans.

### 2.8 Secondary Materials.

**2.8.1 Waterstops.** Waterstops shall conform to [Section 541](#).

**2.8.2 Bearing Strips.** The bearing strip material shall be ultra-high molecular weight polyethylene (UHMW-PE), 1/4” minimum thickness, 3/8” maximum thickness, grade Virgin Natural or Reprocessed, with rubber-back on one side. The bearing strip shall be one of the products listed on the [Qualified Products List](#).

**2.8.2.1** The bonding agent used with the construction of the expansion surface shall be product recommended by the manufacturer of the rubber-backed UHMW-PE.

### 2.9 Grout for Bonding Fresh Concrete to Hardened Concrete.

**2.9.1** Grout for bonding fresh concrete to existing hardened concrete shall consist of equal parts by weight of Portland cement and sand, mixed with sufficient water to form a slurry. The consistency of this slurry shall be such that it can be applied with a stiff brush or broom to the old concrete in a thin, even coating that will not puddle in low spots. For sealing vertical joints around repair or between adjacent lanes of overlay and at the curbs, the grout shall be thinned to paint consistency.

### 2.10 Storage of Concrete Materials.

**2.10.1** The handling and storage of concrete materials shall be such as to prevent their segregation or contamination by foreign materials. When directed, the aggregates shall be stored on suitable platforms or on clean, level, paved surfaces if segregation or contamination continues to occur. Aggregates shall be stored in separate stockpiles sufficiently removed from each other to prevent the aggregates from becoming intermixed. To prevent spillage from one bin to the next, buckets used to fill the bins shall not be wider than the clear opening of the bins. Evidence of intermixing, segregation, or contamination will be cause for rejection.

**2.10.2** Unless otherwise permitted, cement shall be stored in approved weatherproof silos or buildings which will protect the cement from dampness. The floors of the buildings shall be sufficiently clear of the ground to prevent the absorption of moisture.

When storage in the open is permitted, the cement shall be placed on raised platforms and completely covered with a waterproof covering.

**2.10.3** The locations of the stockpiles and the facilities for storing cement shall be subject to approval.

**2.10.4 Storage of Fly-Ash or Ground Granulated Blast Furnace Slag.**

**2.10.4.1** The approved fly-ash or ground granulated blast furnace slag shall be stored in weather-tight storage facilities at the source and the concrete plant. The storage facilities shall be subjected to approval by the Department. All storage facilities shall be completely empty and clean before fly-ash or ground granulated blast furnace slag is deposited therein unless they contain fly-ash of the same type from the same source.

**2.10.4.2** Fly-ash or ground granulated blast furnace slag from different sources or of different types shall not be stored together in the same storage container. Adding fly-ash or ground granulated blast furnace slag to partially filled storage containers shall be allowed only for fly-ash or ground granulated blast furnace slag of the same type from the same source. Fly-ash added to a partially filled storage container shall not vary from the fly-ash in the container by more than  $\pm 0.5\%$  in Loss on Ignition and by more than  $\pm 5\%$  in Fineness.

**2.10.4.3** Fly-ash or ground granulated blast furnace slag remaining in bulk storage for a period greater than one year after completion of test will be resampled and retested before shipment or use. However, fly-ash or ground granulated blast furnace slag which has been in bulk storage more than two years from the time of original manufacture shall not be used. Fly-ash or ground granulated blast furnace slag stored over the winter at the concrete producing plant shall be retested for specification compliance.

**2.10.5** Shipping fly-ash or ground granulated blast furnace slag shall be in accordance with accepted techniques for bulk Portland cement or as directed by the Department.

**2.11 Concrete Mixes.**

**2.11.1 General.**

**2.11.1.1** The concrete mix shall be composed of a mixture of aggregate, cement, supplemental cementitious materials, water, and chemical admixtures as required. All concrete mix designs shall provide for mitigation of alkali silica reactivity by the following:

**2.11.1.1.1** The Contractor shall supply laboratory test reports that contain data on the mineralogy and potential reactivity for all aggregates being used in the concrete mix. All aggregates shall be tested in accordance with the requirements of AASHTO T 303 to determine alkali-silica reactivity. The laboratory supplying the test results shall provide evidence that the laboratory is properly equipped and qualified to perform the test methods. All test results submitted for alkali-silica reactivity shall be from tests conducted within one calendar year from the date the mix design is submitted to the Department.

**2.11.1.1.2** Mix designs using potentially alkali reactive aggregates shall include mitigation for reactivity and shall be submitted to the Department for approval. Mitigation of potentially reactive aggregates shall consist of one or more of the following methods: use of low alkali cement (less than 0.6 percent  $\text{Na}_2\text{O}$  equivalent); use of a mineral admixture; or use of a chemical admixture. The proposed mitigation method will be accepted for use after the NHDOT Bureau of Materials and Research reviews test results supplied by the Contractor that show the effectiveness of the mitigation. An effective mitigation technique shall reduce the mean expansion to below 0.10% for alkali-silica reactivity when tested in accordance with ASTM C 1567.

In lieu of the above, mitigation may be by substitution of a minimum 25% fly-ash or 50% ground granulated blast furnace slag for cement by weight.

**2.11.2 Method Requirements.**

**2.11.2.1** The Contractor shall submit a mix design appropriate for the raw materials and blends of approved aggregates available for the specific project. The concrete mix design limits given in Table 520-4 or Table 520-5 indicate the master ranges of mixes permissible under this specification. The mix design shall be within the master ranges indicated for the particular class of concrete specified. The mix design for each mix shall establish a single percentage of aggregate passing each required sieve size in accordance with Table 520-4 and Table 520-5, a cement factor and a water cement ratio, target strength and target permeability as shown in Table 520-1A. Approval of the mix design will include a tolerance range between 15 and 35 kilohm-centimeters ( $\text{k}\Omega\text{-cm}$ ). Consideration for values above 35  $\text{k}\Omega\text{-cm}$  will be made for mix designs utilizing ternary blends developed to mitigate for ASR. Gradings which range from the maximum of one sieve size to the minimum of the next will not be permitted. Mix design submittals shall include results of strength and permeability testing. Strength test results shall be comprised of two test cylinders tested for compressive strength at 28 days (a set of two averaged to comprise one strength test) in accordance with AASHTO T 22 & 23. Surface Resistivity testing of one cylinder shall be completed in accordance with AASHTO TP 95 at an age of 56 days. No concrete placement shall be started on a project until the Bureau of Materials and Research has approved the mix design for that placement. The mix design for each mix shall be in effect until modified in writing by the Bureau of Materials and Research.

## SECTION 520

**2.11.2.2** Should a change in sources of material be made, a new mix design shall be submitted per 2.11.2. When unsatisfactory results or other conditions make it necessary, the Engineer may establish a new mix design.

**2.11.2.2.1** Except for Class F, aggregate fractions shall be sized, uniformly graded and combined in such proportions that the resulting mix meets the grading requirements of Table 520-4 or Table 520-5.

**2.11.2.2.2** Alternate mix designs for excavatable flowable fill and other categories of flowable fill, will be allowed, providing the mix design for each is approved by the Bureau of Materials and Research. Other categories of flowable fill might include non-excavatable, ultra-light weight, very flowable or other combinations. Alternative flowable fill mix designs would be used when specified or ordered. All mix designs submitted for approval shall be accompanied by 5 test cylinders, which will be used to determine compressive strength, unit weight and excavatability. Test cylinders will be evaluated at 84 days. Compressive strength test cylinders will be prepared according to ASTM D 4832, as modified by NHDOT Test Procedure P-2.

### 2.11.2.3 Master Ranges for Combined Aggregates.

**Table 520-4 - Coarse Aggregate with Specific Gravity Less Than 2.700**

Sieve Size	Concrete Classes*			Concrete Classes**		
	A <sup>1</sup> , B, and T			A, AA, and AAA		
	Min.	Desired	Max.	Min.	Desired	Max.
	(PERCENT BY WEIGHT PASSING)			(PERCENT BY WEIGHT PASSING)		
1-1/2"	95	100	100			
1"		80			100	
3/4"	56	68	80	94	97	100
1/2"		57			77	
3/8"	38	46	55	51	62	73
No. 4	31	35	39	37	42	47
No. 8		29			34	
No. 16	16	23	30	19	27	35
No. 30		14			17	
No. 50	4	7	10	4	8	12
No. 100	1	2	3	1	2	4
No. 200	0	0	2	0	0	2

\*Class A<sup>1</sup>, B, and T based on fine aggregate content of 32 to 36 percent of the total aggregate.

\*\*Class A, AA and AAA based on fine aggregate content of 38 to 42 percent of the total aggregate.

<sup>1</sup> See footnote to Table 520-3.

**Table 520-5 - Coarse Aggregate with Specific Gravity 2.700 and Over**

Sieve Size	Concrete Classes*			Concrete Classes**		
	A <sup>1</sup> , B, and T			A, AA, and AAA		
	Min.	Desired	Max.	Min.	Desired	Max.
	(PERCENT BY WEIGHT PASSING)			(PERCENT BY WEIGHT PASSING)		
1 1/2"	97	100	100			
1"		83			100	
3/4"	57	69	82	95	97	100
1/2"		61			81	
3/8"	45	52	59	55	65	76
No. 4	36	40	44	42	47	53
No. 8		34			40	
No. 16	20	27	35	22	31	40
No. 30		17			19	
No. 50	4	8	12	5	9	14
No. 100	1	2	4	1	2	4
No. 200	0	0	2	0	0	2

\*Class A<sup>1</sup>, B, and T based on fine aggregate content of 38 to 42 percent of the total aggregate.

\*\*Class A, AA, and AAA based on fine aggregate content of 44 to 48 percent of the total aggregate.

<sup>1</sup> See footnote to Table 520-3.

**2.11.3 Performance Requirements (QC/QA).**

**2.11.3.1** Aggregate fractions shall be sized, uniformly graded, and combined in such proportions, that the resulting mix meets the grading requirements of the Contractor's concrete mix design.

**2.11.3.2** Thirty (30) days prior to the first concrete placement for each class of concrete specified, a concrete mix design shall be submitted to the Bureau of Materials and Research for approval. No class of concrete shall be placed on a project until its mix design is approved. The mix design shall contain the following:

- Compressive Strength
- Amount of Cement lb/cy (Including supplemental cementitious materials)
- Fine and Coarse Aggregate Gradation
- Air Content
- Water/Cement Ratio
- Chemical admixtures (types, Brand names, dosage ranges)
- Laboratory test results (Strengths, Air Content, W/C ratios, Slump)

**2.11.3.3** Should a change in sources of material be made, a new mix design shall be submitted per 2.11.3.2. When unsatisfactory results or other conditions make it necessary, the Engineer will require a new mix design.

**Construction Requirements****3.1 Proportioning and Batching.****3.1.1 Proportioning.**

**3.1.1.1** All ingredients shall be measured by weight unless otherwise permitted. Scales shall be approved beam type with a separate tare beam or springless dial type, accurate to within 0.5 percent of the total load.

**3.1.1.2** Cement shall be weighed on a separate scale. Weights for bagged cement, when its use is permitted, shall be as specified on the bag; fractional bags shall not be used.

**3.1.1.3** Aggregate weights shall be saturated surface dry weights adjusted for moisture.

**3.1.1.4** Mixing water shall consist of free moisture on the aggregates, ice if added, and water added to the batch. Water added to the batch shall be measured by weight or an approved volumetric method to an accuracy of 1 percent. Water meters shall be so installed that they are unaffected by pressure or temperature changes in the water supply. Graduated tanks shall be equipped with outside taps and valves for checking their calibration.

**3.1.1.5** Each approved admixture shall be added to a separate portion of the fine aggregate or water as recommended by the manufacturer to eliminate premixing of the additives. Separate calibrated standpipes with positive action discharge tubes, readily visible from the batching area, shall be provided at all concrete producing plants regardless of metering devices.

**3.1.1.6** The ratio of substitution of cement to fly-ash or cement to ground granulated blast furnace slag shall be 1:1 by weight.

**3.1.1.7** When specified on the plans, corrosion inhibitor (calcium nitrate) admixture shall be as shown on the [Qualified Products List](#). Corrosion inhibitor shall be used at the rate recommended by the manufacturer unless otherwise directed by the Engineer.

**3.1.2 Batching.**

**3.1.2.1** Batch plants shall meet the requirements of AASHTO M 157 except as modified herein. The plants shall have one bin for fine aggregate and one bin for each required size of coarse aggregate. Each bin shall discharge efficiently and freely into the weighing hopper.

**3.1.2.2** All new, replaced, or major modification of existing batching plants shall be equipped for fully automatic proportioning and batching of all ingredients including admixtures.

**3.1.2.2.1** Automatic batching plants shall be controlled by means of an approved automatic batch selector set to accurately deliver in proper sequence the designed mix proportions and admixtures required for the batch. The batch selector controls shall be locked and sealed during operation. Changes in selector controls or weight settings shall not be made without authorization. Provisions shall be made to vary the size of the batch without affecting the proportions of the design mix.

**3.1.2.2.2** All batch equipment in automatic plants shall be interlocked to prevent the discharge of any ingredient into the system until all batching controls have been cleared of the previous batch and the discharge gates and supply valves are closed.

**3.1.2.2.3** A moisture meter equipped with automatic adjustable compensating controls shall be installed to accurately and continuously measure the moisture content of the fine aggregate. The moisture compensating dial shall automatically adjust the

## SECTION 520

amount of batch water added and the batch weight of the fine aggregate consistent with the variations of free moisture in the fine aggregate.

**3.1.2.2.4** If the automatic proportioning devices become inoperable or malfunction during a concrete placement, the plant may operate manually for the completion of the pour. If the breakdown is readily correctable or is due to a condition within the producer's control, the plant will not be permitted to operate. If unavailability of parts or service or any condition beyond the producer's control exists, written permission may be given to operate the plant manually for a specified period. Accuracy shall be maintained as specified in 3.1.1.

### 3.1.3 Testing Equipment and Facilities.

#### 3.1.3.1 Method Requirements.

**3.1.3.1.1** The necessary equipment as specified and ordered shall be provided at all batch plants. Approved enclosed space for the use of the Engineer for storage and use of the testing equipment shall be provided including proper lighting, ventilation, and heat. The equipment shall include the following:

- (a) Set of 8" brass sieves, full height- 2", sizes 3/8", Nos. 4, 8, 16, 30, 50, 100, 200, with pan and cover.
- (b) Motor driven shaker for 8" sieves.
- (c) Scale, 2,000 gram capacity, 0.1 gram sensitivity.
- (d) Approved motor drive mechanical shaker, tray size 18 by 26", 2-1/3 ft<sup>2</sup>; screen sizes 1-1/2", 1", 3/4", 1/2", 3/8", No. 4 and No. 8.
- (e) Field scale, 70 lb. capacity, and 0.1 lb. sensitivity.
- (f) Drying equipment, hot plate or oven with tins.
- (g) Speedy Moisture Tester, 26-gram size. If approved electronic probes are used, the Speedy Moisture Tester requirement may be waived.
- (h) Sample splitter (riffle type).

**3.1.3.1.2** The following test equipment shall be furnished on all projects calling for 10 cy or greater of concrete unless specifically waived:

- (a) Slump test set, (AASHTO T 119)
- (b) Air-Entrainment Meter (AASHTO T 152, Type B)
- (c) Curing box for concrete cylinders\*
- (d) Scoop and squared trowel, minimum 6" blade.

On projects with more than 100 CY. of concrete, the following additional test equipment will also be required:

- (e) Scale, minimum 70 lb. capacity, 0.1 lb. sensitivity
- (f) Steel "Contractor's" wheelbarrow
- (g) Hoe and hand shovel
- (h) Ten foot metal straightedge
- (i) Microwave oven, 700 watt, 120 volt, 60 hertz, minimum 1.3 ft<sup>3</sup>, variable power from 10 to 100 percent.
- (j) A scale, minimum capacity of weighing a 5 kilogram sample, 1.0 gram sensitivity.

\* On projects with less than a total of 100 cy of concrete, the curing box shall be relatively airtight with provisions for storing cylinders in damp sand or sawdust at temperatures between 60° F and 80° F. On projects with more than 100 cy of concrete, the curing box shall comply with the following specifications:

The internal dimensions shall be approximately 30" long by 18" wide by 19" deep. The top shall be hinged at the back and a lock shall be provided at the front. The interior shall be rustproof. A moisture-proof seal shall be provided between the lid and the box.

A drain pipe shall be provided through the side of the box. A grating shall be provided to hold the concrete cylinders above the water surface.

A minimum/maximum thermometer shall be installed to measure the internal temperature of the box. The thermometer shall be readable from outside of the box and shall be accurate to within 2 °F. The thermometer shall have minimum graduations of 2 °F. A thermostat shall maintain the water at a temperature of 72 ± 5 °F when the ambient temperature is as low as -10 °F.

**3.1.3.1.3** When concrete is placed at more than one location simultaneously, the necessary testing equipment shall be furnished at each location.

**3.1.3.1.4** Testing equipment shall be calibrated by the Contractor in accordance with [106.03](#).

#### 3.1.3.2 Performance Requirements (QC/QA)

**3.1.3.2.1** The following test equipment shall be furnished on all projects calling for 10 cy or greater of concrete unless specifically waived:

- (a) Slump test set, (AASHTO T 119).
- (b) Air-Entrainment Meters (AASHTO T 152, Type B).
- (c) Curing box for concrete cylinders.
- (d) Provide a sufficient number of boxes to hold all the required number of concrete test cylinders for a minimum period of 48 hours.
- (e) Scoop and squared trowel, minimum 6" blade.

On projects with more than 100 CY of concrete, the following additional test equipment will also be required:

- (f) Scale, minimum 70 lb. capacity, 0.1 lb. sensitivity.
- (g) Steel " Contractor's" wheelbarrow.
- (h) Hoe and hand shovel.
- (i) Ten foot metal straightedge.
- (j) Microwave oven, 700 watt, 120 volt, 60 hertz, minimum 1.3 ft<sup>3</sup>, variable power from 10 to 100 percent. (Provide 2 for QC/QA).
- (k) A scale, minimum capacity of weighing a 5 kilogram sample, 1.0 gram sensitivity.
- (l) Sufficient number of microwave safe ceramic or porcelain dishes.

**3.1.3.2.3** When concrete is placed at more than one location simultaneously, the necessary testing equipment shall be furnished at each location.

**3.1.3.2.4** Testing equipment shall be calibrated by the Contractor in accordance with [106.03](#).

#### **3.1.4.1 Method Requirements**

**3.1.4.1.2** Mortar proportions shall be kept to the lowest that will provide the desired workability. Mixing water shall be kept to the minimum that will produce the required consistency as measured in accordance with AASHTO T 119, as modified in 3.1.6, and does not exceed the water/cement ratio established by Table 520-1A unless authorized by the Engineer. Slumps shall be kept within the following limits unless otherwise permitted:

Footings and mass concrete	1 - 3"
Columns and pedestals	2 - 4"
Decks and sidewalks	2 - 3"
Tremie concrete	6 - 8"
Walls over 18" thick	2 - 3"
Walls 18" thick and under	2 - 4"
Concrete with High Range Water Reducer	8" max.

#### **3.1.5 Air-Entrainment.**

**3.1.5.1** Air-entrainment of the required percentage shall be obtained by the use of air-entraining admixture unless otherwise permitted. Air content will be determined in accordance with AASHTO T 152, except as modified in 3.1.6.1.

**3.1.5.2** The percentage of air-entrainment for pumped concrete shall be taken at the discharge end of the pump line.

#### **3.1.6 Testing.**

##### **3.1.6.1 Method Requirements.**

**3.1.6.1.1** Test cylinders shall be made in accordance with AASHTO T 141 except that the entire sample for test cylinders and testing air-entrainment and slump may be taken at one time from the middle of the batch. Errors in proportioning or mixing as evidenced by excessive slump will be cause for rejection. Cylinders shall be made and cured in accordance with AASHTO T 23. To determine compliance with Table 520-1A, cylinders shall be tested in accordance with AASHTO T 22 and the test strength shall be the average compressive strength of at least two cylinders tested at the end of the 28 day curing period.

**3.1.6.1.1.1** For concrete class F, flowable fill cylinders for compressive strength tests will be prepared when required in accordance with ASTM D 4832 as modified by NHDOT Test Procedure P-2.

**3.1.6.1.2** When ordered by the Engineer, mixes will be reviewed for use by test samples of at least 5 cy a minimum of 14 days prior to use on the project. Tests for water/cement ratio, air content and final slump on fresh concrete at maximum delivery time shall be performed. Cylinders for testing strength and permeability will be made and tested by the Department, if required. Tests of workability and finishing characteristics as well as any other test deemed necessary will be performed. Payment for test samples will be per [109.04](#).

**3.1.6.1.3** Unit weight shall be determined in accordance with AASHTO T 121.

## SECTION 520

### 3.1.6.2 Performance Requirements (QC)

**3.1.6.2.1** The Contractor shall administer an approved Process Quality Control Plan for each QC/QA Concrete class specified, hereinafter referred to as the “ Plan”, sufficient to ensure a product which meets the Contract requirements. The Plan shall meet the requirements of [106.03.1](#).

**3.1.6.2.1.1** The Plan shall address all elements that affect the quality of the structural concrete including, but not limited to, the following:

- (a) Mix Design(s); including aggregate source and gradations
- (b) Concrete Supplier and Plant Location
- (c) Quality of Components
- (d) Stockpile Management
- (e) QC Inspection Activities
- (f) QC Testing and Inspection Report Forms and Process for Department Submittal
- (g) Process Quality Control Testing: include details for frequency, location and sampling methods for slump, air content, water content, temperature, and evaporation rate.
- (h) Placement Method(s), Concrete in place time, and Consolidation including proposed backup equipment.
- (i) Proposed Finishing Machines
- (j) Evaporation Control Procedures
- (k) Finishing and Curing Methods
- (l) Version of the Specification to be used.

**3.1.6.2.1.2** The Plan shall include the following personnel performing the described functions and meeting the following minimum requirements and qualifications:

- a) **Plan Administrator** shall hold certification as NETTCP QA Technologist and meet one of the following qualifications:
  - 1) Professional Engineer registered in the State of NH with one year of highway experience acceptable to the Department.
  - 2) Engineer-In-Training certified by the State of NH with two years of highway experience acceptable to the Department.

An individual with three years highway experience acceptable to the Department and with a Bachelor of Science Degree in Civil Engineering or an Associate’s Degree in Civil Technology or Construction.

- b) **Process Control Technician(s) (PCT)** shall utilize test results and other quality control practices to ensure the quality of aggregates and other mix components and control proportioning to meet the mix design(s). The Plan shall detail the frequency of sampling and testing, corrective actions to be taken, and documentation. The PCT shall periodically inspect all equipment utilized in proportioning and mixing to ensure it is operating properly and that proportioning and mixing conforms with the mix design(s) and other Contract requirements. The Plan shall detail how these duties and responsibilities are to be accomplished and documented and whether more than one PCT is required. The Plan shall include the criteria utilized by the PCT to correct or reject unsatisfactory materials. The PCT shall be a New England Transportation Technician Certification Program Concrete Technician Level I or be a Construction Materials Technician Trainee under direct observation of a New England Transportation Technician Certification Program Concrete Technician Level I.
- c) **Quality Control Technician(s) (QCT)** shall perform and utilize quality control tests at the job site to ensure that delivered materials meet the requirements of the mix design(s), including temperature, water/cement ratio, air content, and strength. The QCT shall inspect all equipment utilized in transporting, placing, consolidating, finishing, and curing to ensure it is operating properly and that placement, consolidation, finishing, and curing conform with the Contract requirements. The Plan shall detail frequency of sampling and testing, corrective actions to be taken, and documentation. The Plan shall detail how these duties and responsibilities are to be accomplished and documented, and whether more than one QCT is required. The Plan shall include the criteria utilized by the QCT to reject unsatisfactory materials. The QCT shall meet the same qualifications as the PCT.

**3.1.6.2.1.3** The Plan shall detail the coordination of the activities of the Plan Administrator, the PCT and the QCT.

**3.1.6.2.1.4** The Contractor shall provide a Delivery Record for each truckload of concrete. The Delivery Record shall include:

Contract Name & Number  
Bridge Number  
Manufacturing Plant (Batching Facility)  
Name of Contractor (Prime Contractor)



Date  
 Time Batched/Time Discharged  
 Truck Number  
 Load Number  
 Quantity (Quantity Batched this Load)  
 Target Weights Per cubic yard and Actual Batched Weights for:

1. Cement
2. Supplemental cementitious materials - Fly Ash, Ground Granulated Blast Furnace Slag and/or Silica Fume
3. Coarse Aggregate
4. Fine Aggregate
5. Water (including water added at the batch plant and at the project site)
6. Air-Entraining, Water Reducing and/or other Admixtures including brand, type, and quantity.
7. Aggregate Moisture (Percent)

The Delivery Record shall be signed by a Process Control Technician affirming the accuracy of the information provided.

**3.1.6.2.1.5** Concrete placed shall be sampled, tested, and evaluated by the Contractor in accordance with the minimum process quality control requirements in Table 520-6:

**Table 520-6 - Minimum Process Quality Control Requirements Class AA**

Property	Test Frequency	Test Method
Slump	First 3 Loads per Pour Per Class of Mix Then as Needed to Control Operations, or When Visual Change in Mix or Change on the Certificate of Compliance	AASHTO T119
Air Content		AASHTO T152
Temperature		ASTM C 1064
Strength	As Needed to Control Operations	AASHTO T22 & 23
Water Content	As Needed to Control Operations	Per Approved Plan
Evaporation Rate <sup>(1)</sup>	Once per subplot	Per Appendix B

<sup>(1)</sup> For Concrete Class AA used in bridge decks and at grade approach slabs only.

**Table 520-6a - Minimum Process Quality Control Requirements Class A and B**

Property	Test Frequency	Test Method
Slump	As Needed to Control Operations	AASHTO T119
Air Content	As Needed to Control Operations	AASHTO T152
Temperature	As Needed to Control Operations	ASTM C 1064
Strength	As Needed to Control Operations	AASHTO T22 & 23
Water Content	As Needed to Control Operations	Per Approved Plan

**3.1.6.2.1.5.1** Water content will be controlled by a method proposed in the plan and approved by the Engineer. Concrete not meeting the plan minimum requirements for air content shall not be incorporated in the work.

### 3.1.6.3 Performance Requirements - Quality Assurance (QA)

**3.1.6.3.1** Structural concrete designated for acceptance under Quality Assurance (QA) provisions will be sampled once per subplot on a statistically random basis. Samples will not be taken until the Contractor has accepted the material for placement. Samples will be obtained in accordance with AASHTO T 141 as amended in 3.1.6.3.3 and will be tested and evaluated by the Department in accordance with [106.03.2](#) and the acceptance testing schedule in Table 520-7:

**Table 520-7 - Acceptance Testing Schedule**

Property	Sublot Size	Test Method
Strength	See 520.3.1.6.3.2.1	AASHTO T 22 & 23
Permeability	See 520.3.1. 6.3.2.1	AASHTO TP 95
Air Content	See 520.3.1. 6.3.2.1	AASHTO T 152
Water/Cement Ratio	See 520.3.1. 6.3.2.1	NHDOT Microwave
Concrete Cover	Each Data Point	Rebar Depth Measuring Unit See 520.3.1.6.3.6

## SECTION 520

**3.1.6.3.2 Lot Size.** For the purpose of evaluating all acceptance test properties, a lot for Class A and B shall consist of the total quantity represented by each QC/QA Concrete item mix design. On Contracts which include multiple structures a lot shall consist of the total quantity represented by each QC/QA Concrete item mix design for each structure. Each structure will be evaluated as a separate lot. The unit price for each QC/QA item will be determined per 5.8.1 for each structure. A lot for Class AA shall be a day's placement. A day's placement will be defined as all concrete placed on the same day or a continuous placement occurring over two or more days. For a lot to be evaluated for pay adjustment, it must have at least three sublots.

**3.1.6.3.2.1 Sublot Size.** The following schedule will determine the number and size of sublots for a day's placement.

**Table 520-8 Class A and B Number and Size of Sublots**

<b>Days Placement per QC/QA Concrete Item</b>	<b>Number of Sublots</b>
0 to 50 CY. inclusive	1
>50 to 150 CY. inclusive	2 split equally
>150 to 300 CY. inclusive	3 split equally
Over 300 CY.	Split equally <sup>(1)</sup>

<sup>(1)</sup> Sublots shall be greater than or equal to 100 cubic yards and less than 135 cy.

**3.1.6.3.2.2 Sublot Size for Class AA.** A sublot for Class AA shall typically be 50 cy. Lots less than 175 cy. shall be split equally into three equal sublots. A day's placement of less than 50 cy. shall be tested as a sublot of the previous lot (if there is no previous lot it shall be a sublot of the subsequent lot). The last sublot shall be greater than or equal to 25 cy. and less than 75 cy.

**3.1.6.3.2.3 Sublot Size for Class A and B.** If a QC/QA Class A or B concrete item cannot be evaluated with at least three sublots using the above Table 520-8, then the Engineer's estimate of the total quantity for that QC/QA concrete item will be split equally into three sublots.

**3.1.6.3.3** When concrete is placed by pumping, samples will be taken at the discharge end of the pump.

**3.1.6.3.4 Permeability Testing.** One 4" x 8" cylinder shall be fabricated from all placements for Class AA and for Class A concrete. Preliminary Surface Resistivity Testing will be conducted on cylinders and performed in accordance with AASHTO TP 95. The Pay Factor for the sublot shall be based upon the testing of one cylinder at an age of 56 days or later. One sample will be taken per sublot placed. When concrete is specified to contain a corrosion inhibitor containing calcium nitrite, permeability testing will not be done and the pay factor for this concrete will be 1.0.

**3.1.6.3.5 Water Cement Ratio.** Water Cement Ratio shall be determined using the New Hampshire Department of Transportation microwave method as described in [Appendix A](#).

**3.1.6.3.6 Concrete Cover.** Concrete cover over reinforcing steel will be evaluated by the Bureau of Materials and Research. The Contractor shall give three working days' notice to the Bureau of Materials and Research of the availability of the concrete section to be measured. A date will be scheduled to measure the cover. Prior to measurement, the Engineer will provide locations for the measurements to be taken. The Contractor shall be responsible for marking the layout for rebar cover measurement and shall ensure adequate accessibility for measurement apparatus on the concrete section to be measured on the date scheduled. Concrete cover over reinforcing steel will be evaluated as follows:

- a) **Bridge Decks.** Concrete cover will be determined with a radar rebar depth measuring unit. A run of measurements will be taken parallel to the centerline within each lane over 10 feet wide. A hole for calibration shall be taken for each placement. A depth verification hole shall be taken for each run. Coping areas, backwalls and areas on the deck where the top and bottom of the deck are not parallel or where the angle at the crown is changing will not be evaluated for cover.
- b) **Pedestrian sidewalks.** Concrete cover will be determined with a radar rebar depth measuring unit. A run of measurements will be taken along the centerline of the sidewalk. One hole will be taken for depth calibration. Concrete in the sidewalks will be evaluated as a separate lot for cover
- c) **At Grade Approach Slabs.** Concrete cover will be determined with a radar rebar depth measuring unit. A run of measurements will be taken parallel to the centerline within each lane over 10 feet wide. A depth verification hole will be taken for each run for calibration.
- d) **Rail support slabs.** Concrete cover will be determined with a radar rebar depth measuring unit. A run of measurements will be taken parallel to the curb line, offset 1'-6" towards the roadway edge of the slab. A depth verification hole will be taken for each run for calibration.

**3.1.6.3.7** Evaluation of materials will be made using the specification limits in [Table 520-1B](#).

**3.1.6.3.7.1** Concrete produced in accordance with a Contractor-provided mix design which fails to meet the specified compressive strength at 28 days, based on the average of two concrete cylinders per sublot, will be evaluated by comparison of the actual compressive strength (f'ca) with the specified compressive strength (f'c) as follows:

1. If  $(f'c - f'ca)$  is less than 60 psi, the concrete will be accepted as being in conformance and no pay adjustment shall apply.
2. If the  $(f'c - f'ca)$  value is between 60 and 500 psi the Engineer may:
  - a) Require corrective action at no additional expense to the Department; or
  - b) Accept the concrete with a calculated pay adjustment as described in 5.9.2.
3. If the  $(f'c - f'ca)$  value is greater than 500 psi, the lot will be rejected and subject to the provisions of 106.03.2.2.

**3.1.6.3.7.2** On bridge decks, approach slabs and rail support slabs, when the average actual concrete cover over the top bar of the top mat of the reinforcing steel is less than the lower specification limit, the Contractor shall correct the deficiency. A plan to correct the deficiency shall be submitted to the Engineer for review and acceptance prior to performing any work. An acceptable plan could include, but not be limited to, grinding the surface and applying a concrete overlay.

When the average concrete cover over the reinforcing steel is greater than the upper specification limit corrective action may be required.

**3.1.6.3.7.3** Concrete placement operations may be suspended when the pay factor of any property for a lot, as determined in accordance with 106.03.2.4:

1. Drops below 1.00 and the Contractor is taking no corrective action, or
2. Is less than 0.90.

The placement operations shall not resume until the Engineer determines that material meeting the Contract requirements can be produced.

## 3.2 Forms and Falsework.

**3.2.1** Drawings and data for falsework shall be submitted for documentation in accordance with 105.02. A concrete density of 150 lb/ft<sup>3</sup> and a live load of 50 lb/ft<sup>2</sup> shall be used in calculations. Adequate provisions shall be made for the effect of vibration and impact on the forms and falsework.

**3.2.2** Wood forms and bracing materials shall be of approved lumber, mortar tight, and free of imperfections on exposed surfaces. Forms shall have sufficient studs, walers, and stiffbacks to eliminate bulging and shrinking. Surfaces which will be exposed to view in the final structure shall be formed with plywood unless otherwise specified or permitted. Plywood which will not give a concrete finish essentially equal to new plywood shall not be used. All plywood shall be placed with the grain horizontal.

**3.2.3** Forms shall be installed to the lines and grades shown on the plans or ordered. Forms for grade lines exposed to view such as top of curbs, walls, bearing areas, and the like, shall be cut to grade unless otherwise permitted. Wood in contact with the concrete shall be treated with an approved form release compound prior to erection. Cleaning and inspection ports shall be provided as ordered.

**3.2.4** Ties and anchorages for use in forms above the top of footings shall be fabricated so as to be removed to a minimum depth of 2" without injury to the concrete.

**3.2.5** Chamfer strips shall be installed as shown on the plans or ordered. Joints which are to receive external waterproofing shall not be chamfered.

**3.2.6** Metal forms shall comply with the pertinent requirements of 3.2.2. Projections into the finished concrete surface will not be permitted. Connection devices shall hold the forms rigidly in alignment and shall be removed without injury to the concrete.

**3.2.6.1** Forms made of other materials such as fiberglass or plastic may be used when permitted.

**3.2.7** Falsework shall be placed on an approved solid footing or piling. Provisions shall be made for adjusting forms to grade and compensating for settlement during placement of concrete. Improper or inadequate bracing shall be satisfactorily corrected.

**3.2.8** Stay-in-place deck forms shall not be used unless specifically allowed on the plans.

## 3.3 Weepers and Drains.

**3.3.1** Four inch weepers at approximately 10 ft. on centers shall be placed at the elevations shown or ordered unless otherwise directed. Coarse gravel or stone shall be placed at the inlets and outlets to permit unobstructed flow of the weepers. An approved geotextile patch may be substituted on the inlet end of weepers in place of the coarse gravel or stone.

## 3.4 Ready-Mixed Concrete.

### 3.4.1 General.

**3.4.1.1** Ready-mixed concrete is defined as Portland cement concrete manufactured for delivery in a plastic state. It shall be in compliance with AASHTO M 157 or as modified herein.

## SECTION 520

**3.4.1.2** Ready-mixed concrete shall be mixed and delivered to the point designated by means of one of the following combinations of operations:

- (a) Central-mixed concrete. Mixed completely in a stationary mixer and delivered in a truck mixer operating at agitation speed.
- (b) Shrink-mixed concrete. Mixed partially in a stationary mixer and the mixing completed in a truck mixer.
- (c) Transit-mixed concrete. Mixed completely in a truck mixer.

**3.4.1.3** Non-agitating equipment will not be permitted for transportation.

### 3.4.2 Mixers.

**3.4.2.1** Each mixer shall have metal plate or plates attached in a prominent place by the manufacturer, plainly marked with the gross volume of the drum, the capacity of the drum or container in terms of the volume of mixed concrete, and the mixing and agitating speeds. The volume of mixed concrete shall not exceed 63 percent of the total volume of the drum or container when the concrete is in transit or shrink-mixed, or 80 percent of the total volume when the concrete is central-mixed. Stationary mixers shall be equipped with an acceptable timing device that will not permit the batch to be discharged until the specified mixing time has elapsed.

**3.4.2.2** When loaded to capacity, all mixers shall be capable of combining the ingredients of the concrete into a thoroughly mixed and uniform mass, and of discharging the concrete with a satisfactory degree of uniformity at a rate which will not inhibit the rate of placement required. The rate of discharge shall be governed by the speed of rotation and not by restrictions of the discharge opening.

**3.4.2.3** Mixers will be subject to inspection as frequently as considered necessary. If found unfit to function properly, the mixers will be disapproved for use until correct operating conditions have been restored. The pickup and throw-over blades shall be replaced or repaired when they have become worn 1" or more below the original height of the manufacturer's design, or have become loose, broken, bent, scalloped, or otherwise damaged. Any accumulation of hardened concrete shall be removed.

**3.4.2.4** The Engineer may make tests for consistency of individual samples at approximately the beginning, the midpoint, and the end of the load. If the concrete is not of uniform quality, the mixer shall not be used until the condition is corrected and the mixer has been reinspected and approved.

### 3.4.3 Mixing.

**3.4.3.1** Mixers shall be operated within the limits of their capacity as specified in 3.4.2.1 or as designated by the manufacturer of the equipment, whichever is less, and shall not exceed the speed of rotation designated by the manufacturer.

**3.4.3.2** When shrink-mixed or central-mixed concrete is used, mixing time shall be measured from the time all the solid material is in the drum. The batch shall be so charged that some water will enter in advance of the cement and aggregates and all water will be in the drum by the end of the first one fourth of the specified mixing time.

**3.4.3.3** Where mixer performance tests have not been made, the minimum mixing time for mixers having capacities less than 1 cy shall be 1 minute. For mixers of greater capacity, the minimum mixing time shall be increased by 15 seconds for each cubic yard of additional capacity or fraction thereof.

**3.4.3.4** When shrink-mixed concrete is used, the mixing time in the stationary mixer shall be at least that required to intermingle the ingredients. After transfer to a truck mixer, mixing at mixing speed and turning at agitating speed will be required as specified in 3.4.3.5.

**3.4.3.5** When transit-mixed concrete is used, mixing shall be performed at the site of the work unless otherwise permitted. If the required uniformity is not obtained within 100 revolutions of the mixer after all ingredients are in the drum, that mixer shall not be used until the condition is corrected. Additional revolutions of the mixer beyond the number found to produce the required uniformity shall be at agitating speed except as stated in 3.4.3.7.

**3.4.3.6** The Contractor shall provide a delivery record for each truckload of concrete. The delivery record shall include but not be limited to: date, time batched/time discharged, quantity (quantity batched this load), actual batched weights of: cement, admixtures, water, aggregates and aggregate moisture (percent). Target weights or out of tolerance notification will also be given for each of the actual batched weights given on the delivery record.

**3.4.3.7** Water shall not be added after the initial introduction of the mixing water to the batch except when the slump is unsatisfactory. Such additional water as necessary, up to the amount permitted in 1.2, may be added to bring the slump within the limits specified in 3.1.4. The drum shall then be turned an additional 30 revolutions at mixing speed. Water shall not be added at any later time unless permitted.

**3.4.3.8** Mixing shall begin within the 30 minute period after the cement has been added to the aggregates unless otherwise permitted.

**3.4.3.9** When pumps are used, truck mixers shall be scheduled and adjusted to the capabilities of the pumping units and the rate of placement to provide continuous pumping without excessive waiting time before discharge. Whenever possible, pumps shall be placed so that 2 trucks may discharge into the pump hopper at the same time. Actual discharge shall be such that the last of the load of one is discharged into the hopper with the beginning portion of the other.

**3.4.3.10** Additional high range water reducing admixture, not to exceed the manufacturer's recommendation, may be required to be added at the project to reach slump requirements.

### **3.5 Placing Concrete.**

#### **3.5.1 General.**

**3.5.1.1** The Contractor shall notify the Engineer at least three working days in advance of each concrete placement to allow sufficient time to schedule required inspection and testing. A pre-pour conference shall be mandatory prior to any deck placement.

**3.5.1.2** Concrete shall not be placed without inspection. Concrete so placed will be removed at the Contractor's expense unless authorized by the Engineer.

**3.5.1.3** Approval will be required for alignment and grade, formwork and bracing, reinforcing steel and other inclusions, and the cleanliness of the forms prior to placing concrete.

#### **3.5.2 Equipment.**

**3.5.2.1** All equipment used in placing concrete shall be approved for the particular use intended. Equipment which will be in contact with the fresh concrete shall be mortar-tight and free of caked-on mortar and other contaminants. If other methods are not satisfactory, sandblasting will be required for cleaning.

**3.5.2.2** Crane buckets for placing concrete shall be low-slump type unless otherwise permitted.

**3.5.2.3** Chutes, when permitted, shall be of approved materials and installed so as to prevent segregation. Any sign of segregation will result in rejection of chuting and utilization of an alternate approved method of placement.

**3.5.2.4** Aluminum shall not be used in any equipment where it would be in contact with the fresh concrete.

**3.5.2.5** When pumping concrete, the number and lengths of flexible lines shall be kept to the minimum required for distribution. Transition sections used to reduce the diameter of lines shall be of slickline material and shall be as long as possible.

#### **3.5.3 Placing.**

##### **3.5.3.1 General.**

**3.5.3.1.1** Concrete shall be placed in its final location as soon as possible after mixing. Segregation of the mix or displacement of materials inside the forms will not be permitted.

**3.5.3.1.2** Concrete shall be placed in layers not to exceed 12" and placing intervals shall not exceed 30 minutes unless otherwise permitted. Concrete which has attained a partial set shall not be used.

**3.5.3.1.2.1** When placing deck concrete, concrete shall not be placed more than 10 ft. ahead of the finishing machine.

**3.5.3.1.3** In the event of unscheduled stoppage of the work, vertical bulkheads shall be installed to ensure a minimum depth of 6" of concrete in the next lift of concrete when placement is resumed. See 3.6.2 also.

**3.5.3.1.4** Care shall be taken to keep the concrete pressure on ties and forms within the design limits. Concrete shall not be dropped a distance of more than 5 ft. unless contained within a tremie, elephant trunk, or other approved system.

**3.5.3.1.5** Concrete which has attained its initial set shall not be disturbed by personnel, equipment, or other construction operations for a minimum period of 72 hours unless otherwise permitted.

**3.5.3.1.6** Defective sections of concrete shall be removed and replaced or repaired as directed.

**3.5.3.1.7** Means to contain concrete class F, flowable fill within a designated space shall be provided. Approved methods to prevent pipes from floating during placement of concrete shall be used.

**3.5.3.1.8** For earthen backfill operations or vehicle traffic for paving operations, concrete class F, flowable fill shall be left undisturbed until the material obtains sufficient strength to support the weight of foot traffic without deformation.

**3.5.3.1.9** When concrete is to be placed against granite bridge curb; the granite curb shall have been kept continuously wet for a period of 12 hours before coming into contact with the fresh concrete. Care shall be taken when removing soaking material to ensure that the curbing remains wet until the fresh concrete is placed against it. Any standing water shall be removed before the concrete is placed.

## SECTION 520

**3.5.3.1.10** When concrete is to be placed against any precast concrete member, the precast concrete member shall have been kept continuously wet for a period of 3 hours before coming into contact with the fresh concrete. Care shall be taken when removing soaking material to ensure that the member remains wet until the fresh concrete is placed against it. Any standing water shall be removed before the concrete is placed.

**3.5.3.1.11** Any concrete that is not in place 1 1/2 hours after the cement has been added to the aggregates shall not be used unless otherwise permitted by the Engineer. The Engineer may extend this time limitation if the concrete workability (slump) stills allows for the concrete to be placed without the addition of water to the batch. In hot weather or under conditions contributing to quick loss of workability, a time less than 1 1/2 hours may be required.

### **3.5.3.2 Blank.**

### **3.5.3.3 Performance Requirements (QC/QA).**

**3.5.3.3.1** Concrete in place time shall adhere to section 3.5.3.1.11. Time limitation shall be addressed in the Process Quality Control Plan for approval.

**3.5.3.3.2** Concrete Class AA shall be placed to meet the following conditions for evaporation rates. Charts are given in Appendix B.

1. Evaporation rate shall not exceed 0.2 lb/sq ft/hr for concrete with a water/cement ratio higher than 0.440.
2. Evaporation rate shall not exceed 0.1 lb/sq ft/hr for concrete with a water/cement ratio 0.440 or under.

### **3.5.4 Consolidation.**

**3.5.4.1** Unless otherwise permitted, consolidation of all concrete shall be achieved by the use of approved internal vibrators with a frequency range of 7,000 to 10,000 impulses per minute. Vibrators used in concrete containing epoxy coated reinforcing steel shall be equipped with a non-metallic or non-metallic-coated head. Concrete shall not be moved excessive distances by the use of vibrators.

**3.5.4.2** Vibrators shall be inserted vertically into the fresh concrete and withdrawn slowly. Vibration shall continue until consolidation is achieved and stopped before segregation occurs or water is forced to exterior concrete surfaces in appreciable amounts.

**3.5.4.3** Concrete shall not be placed at a rate greater than that which can be thoroughly consolidated by the vibrators in use. The number of vibrators required will be based on the maximum predicted rate of placement. At least one reserve vibrator shall be furnished.

**3.5.4.4** No consolidation or vibration of concrete class F, flowable fill is required.

### **3.5.5 Depositing Concrete Under Water.**

**3.5.5.1** Unless otherwise specifically permitted, all concrete placed in water shall be placed by tremie. Slump shall comply with 3.1.4.

**3.5.5.1.1** Pumping for underwater placement of concrete shall also be into a tremie unless specific permission is given for direct placement by pump lines. Placement by direct pumping, if permitted, will require the hose to be securely fastened to the cofferdam frame at all times to eliminate surging of the hose in the concrete. If at any time the procedure becomes unacceptable, the remainder of the concrete shall be placed by a tremie. Tremie equipment shall be available on site prior to start of pumping operations.

**3.5.5.2** A tremie shall consist of a watertight tube attached to a hopper of approved size with an adequate working space provided around the hopper. The tremie shall be attached to a crane or other approved hoisting equipment to permit lifting and lowering the tremie with sufficient rapidity to control and stop the flow of concrete as required. The equipment shall be capable of moving the tremie over the entire surface of the placement area.

**3.5.5.3** At the start of placing operations, and at any time thereafter that the tremie is withdrawn from the concrete, an approved watertight plug shall be inserted into the discharge end of the tremie. The tremie shall be lowered until it rests on the bottom or in freshly deposited concrete. It shall then be checked for leaks. If watertight, the tremie tube and hopper shall immediately be filled with concrete. The hoisting mechanism shall then raise the tremie to permit the discharge of the concrete without removal from freshly deposited concrete. The tremie shall then be lowered to stop the flow of concrete before it has dropped below the level of the bottom of the hopper. The hopper shall again be filled and the process repeated until the desired intermediate or final grade is attained. Top concrete surfaces shall be approximately horizontal.

**3.5.5.4** Concrete foundation seals shall be placed as shown on the plans or ordered. The elevation of the top of the seal and the required depth may need to be determined after the excavation is completed.

**3.5.5.5** Test cores of approximately 2" diameter shall be taken by the Contractor through all concrete deposited underwater on rock. The cores shall penetrate a minimum of 1 ft. into the rock. One core shall be taken near each corner and one shall be taken near the center. Should evidence of voids, seams or unsatisfactory concrete be discovered, additional cores shall be taken as ordered. Unsatisfactory material shall be removed and replaced or repaired as directed.

### **3.5.6 Substructure.**

**3.5.6.1** All substructure concrete shall be placed in the dry unless otherwise permitted. Footings shall be placed at the elevations shown on the plans or ordered.

### **3.5.7 Superstructure.**

**3.5.7.1** Compliance with superstructure concrete placing sequences shown on the plans will be mandatory unless prior approval is secured for an alternate sequence. If a pouring sequence is not shown, the Contractor shall submit his proposed pouring sequence for approval. Sufficient concrete placing units shall be furnished to maintain plasticity requirements. If there are multiple placements there shall be more than 72 hours between placements.

**3.5.7.2** Concrete operations on steel structures shall not start until all temporary falsework and bracing have been removed unless otherwise permitted.

### **3.5.8 Bridge Deck Overlays.**

**3.5.8.1 Surface Preparation.** The concrete deck shall be clean and free of laitance, oil, surface moisture, membrane residue, and other foreign materials. Abrasive blast cleaning may be required by the Engineer to achieve a suitable surface.

#### **3.5.8.2 Placing Bridge Deck Overlays.**

**3.5.8.2.1** Prior to placing of concrete, the clean surface shall be thoroughly coated with bonding grout conforming to 2.9 herein.

**3.5.8.2.1.1** Care shall be exercised to ensure that all prepared surface areas receive a thorough, even coating, and that no excess bonding grout be permitted to collect in pockets.

**3.5.8.2.1.2** The grouting operation shall not advance more than 3 to 5 feet ahead of the placing of concrete, but not more than 10 minutes ahead of the finishing machine, unless otherwise directed. Concrete shall be placed while the slurry remains wet. Areas that have dried shall be thoroughly cleaned of all dry slurry and slurry shall be reapplied.

**3.5.8.2.1.3** Bonding grout that has dried, or become unworkable, as determined by the Engineer, shall not be incorporated in the work. No tempering will be permitted.

**3.5.8.2.2** Concrete placed in patches more than 1" deep shall be hand vibrated internally in addition to the surface vibration provided by the finishing machine.

**3.5.8.2.3** At transverse and longitudinal joints, the overlay course previously placed shall be sawn to a straight and vertical edge before the adjacent overlay course is placed.

**3.5.8.2.4** Bridge deck overlays shall not be placed when air or deck temperature is below 45 °F. Decks may be placed when these temperatures are 45 °F and rising temperature is predicted.

**3.5.8.2.5** A construction dam or bulkhead shall be installed in case of major delay in the placement operation. During minor delays of one hour or less, the end of the placement may be protected from drying with several layers of wet burlap.

**3.5.8.2.6** Adequate precautions shall be taken to protect freshly placed concrete from sudden or unexpected rain. The Engineer may order removal of any material damaged by rainfall.

**3.5.8.3** Consolidation of bridge deck overlays shall be performed after the concrete has been screeded by the use of a separate, variable-speed vibrating pan attached to the finishing machine. Vibration shall be continuous until consolidation is achieved and stopped before segregation occurs or water is forced to exterior surfaces in appreciable amounts.

**3.5.8.3.1** Concrete shall not be placed at a rate greater than that which can be thoroughly consolidated by the vibrator in use.

**3.5.8.3.2** Hand vibrators shall be used adjacent to curbing and expansion joints whenever the machine vibrators cannot reach the areas.

**3.5.8.4** Curing of bridge deck overlays shall meet the requirements of 3.10.1 curing method "c". At temperatures below 55 °F, the Engineer may require a longer curing period.

**3.5.8.4.1** Bridges may be opened to automobile traffic only after an initial curing, provided the required curing period has elapsed for all previously placed concrete patches.

## SECTION 520

### 3.5.9 Box Culverts.

**3.5.9.1** Construction Joints shown on the plans or permitted shall be perpendicular to the base slab and normal to the culvert axis. Weepers and drains shall comply with 3.3.

### 3.6 Joints.

#### 3.6.1 General.

**3.6.1.1** All joints not exposed to view in the final structure shall be waterproofed in accordance with 538.

#### 3.6.2 Construction and Contraction Joints.

**3.6.2.1** Joints shown on the plans or permitted shall be keyed, doweled, or both as shown or directed. Sizes and spacings shall be as shown or ordered. Horizontal joints will not be permitted unless shown on the plans or occasioned by breakdown of plant or equipment in which case, in addition to 3.5.3.1.3, planed lumber shall be inserted into the fresh concrete to produce a horizontal line in surfaces which will be exposed to view.

**3.6.2.2** When fresh concrete is to be bonded to previously placed concrete, the abutting surface shall be abraded by sandblasting and cleaned by compressed air. Immediately prior to placing concrete, the abutting surface shall be saturated with water meeting the requirements of [2.5](#).

**3.6.2.3** Where bonding is not desired, the existing concrete shall be coated with an approved form release compound before the adjacent concrete is placed.

#### 3.6.3 Expansion Joints.

**3.6.3.1** Expansion joints shall be constructed at the locations shown and in conformity with the details shown on the plans or ordered.

**3.6.3.2** Open joints shall be formed at the locations shown on the plans. Inserts shall be fabricated so as to permit removal without damage to the work.

**3.6.3.3 Bearing Strips.** The bearing strip material shall be used as an expansion surface between the top of the backwall and bottom of deck at the expansion end of a bridge, as detailed on the plans.

### 3.7 Concreting in Cold Weather.

#### 3.7.1 General.

**3.7.1.1** When the average daily temperature falls below 35 °F for more than 1 day, protective measures shall be taken to prevent damage to the concrete by freezing. The Contractor shall submit his proposed protective methods for approval. Concrete shall be protected from freezing for a minimum of 5 days. Concrete bridge decks shall not be placed without written permission.

#### 3.7.2 Insulation.

**3.7.2.1** Insulation shall be approved blanket, batt or board insulation with a thermal conductivity of less than 0.25 BTU per hour per square foot for a thermal gradient of 1 °F/inch.

#### 3.7.3 Housing and Heating.

**3.7.3.1** Housing for cold weather concreting shall consist of a framework covered with weather tight plastic or canvas and shall be large enough to completely enclose the work to be heated and to accommodate the required heating elements. Continuous maintenance and fire protection shall be provided.

**3.7.3.2** Heaters shall be of approved type and shall be furnished in sufficient quantity to maintain the required temperature without creating hot spots in the concrete.

#### 3.7.4 Concrete.

**3.7.4.1** Concrete shall be brought to the required temperature by the use of heated mixing water or heated aggregates or both. The maximum allowable temperature of water shall be 160 °F and the maximum allowable temperature for aggregates shall be 100 °F. The heated water shall be added to the aggregates prior to the addition of the cement.

**3.7.4.2** Concrete delivery temperature shall be 50° to 70 °F for sections 24” or less in thickness and 40° to 55 °F for sections thicker than 24” unless otherwise permitted.

**3.7.4.3** If the air temperature and transporting distance prevent the delivery of the concrete at the required temperature without exceeding the maximum allowable temperature in 3.7.4.2 the placement shall be canceled until such time as the requirements can be met.



**3.7.4.4** Forms, reinforcing steel, existing concrete and all other materials which will be in contact with the fresh concrete shall be brought to a temperature of 50 °F and all frost shall be removed within the limits of the foundation prior to placing concrete.

**3.7.4.5** Concrete shall be placed in the forms as soon as possible after delivery and as rapidly as possible without exceeding form and tie capacities. Tarpaulins or other approved materials shall be used to cover the top openings in forms to prevent heat loss. Only that portion of the form required for placement shall be opened and the opening shall be recovered between trucks unless otherwise permitted.

**3.7.4.6** Finishing shall be completed as rapidly as possible. On areas where Item 534.3 is not used, liquid curing compound shall be applied to exposed surfaces immediately after finishing. After the concrete has set, plastic shall be placed over the exposed areas. When insulation is used, a covering of approved insulation or a layer of hay and a tarpaulin shall be placed over the plastic and secured in place.

**3.7.4.7** The concrete temperature shall be maintained between 50° and 100 °F for the first 72 hours and between 40° and 100 °F for the next 48 hours. The concrete shall then be permitted to cool at a rate not to exceed 1 °F per hour until it reaches the atmospheric temperature.

**3.7.4.8** During cold weather, cofferdams shall remain dewatered and the concrete kept from freezing for 24 hours following placing. After 24 hours, the Contractor may allow the cofferdam to flood.

### **3.8 Concreting in Hot Weather.**

#### **3.8.1 General.**

**3.8.1.1** The Contractor shall maintain the as delivered concrete below 85 °F. This may require the addition of ice to the mixing water, sprinkling the forms and reinforcing steel, scheduling the concrete placements for early morning or evening hours, or any other approved methods.

**3.8.1.2** After placement, the concrete shall be maintained below 100 °F by sunshades, windscreen, fog spray, wet burlap, or other approved methods.

**3.8.1.3** If excess water demand or too rapid setting is anticipated, a Water-Reducing or Retarding Admixture may be added to the mix in the amounts ordered.

**3.8.1.4** When daytime air temperatures exceed 85 °F, concrete temperature exceeds 80 °F, and in the opinion of the Engineer, satisfactory surface finish cannot be achieved, nighttime or early morning placement may be required. No additional compensation will be allowed for this work.

### **3.9 Finishing Plastic Concrete.**

#### **3.9.1 Surfaces Other Than Decks and Approach Slabs (at grade).**

**3.9.1.1** All upper horizontal surfaces such as the top of wings, bearing pedestals, and the like shall be finished by placing an excess of material in the forms and screeding off the excess after consolidation. The surface shall then be finished by the use of wood, magnesium, cork, canvas floats, or steel trowels as directed.

**3.9.1.2** Catwalks shall receive a magnesium float finish.

**3.9.1.3** Sidewalks shall receive a broom finish by lightly dragging a broom transversely across the finished concrete to roughen the surface unless otherwise directed. Surfaces beneath bridge rail posts, light pole bases, and the like shall not be broomed.

**3.9.1.4** All finishing shall be performed by persons experienced in the use of finishing equipment.

#### **3.9.2 Concrete Decks and Approach Slabs (at grade).**

**3.9.2.1** All concrete decks shall be finished with the use of an approved self-propelled finishing machine with strike-off auger(s), capable of adjustment for crown and width, and capable of raising the screeds to clear the concrete when required unless specific written permission is given for an alternate method. Approach slabs (at grade) shall have the same finish requirements as concrete decks except that the finishing machine does not have to be self-propelled and equipped with auger(s).

**3.9.2.2** Screenshot rails shall be set and checked for the finishing machine to ride on. The rails shall have sufficient rigidity and support to prevent deflection. After the rails are set, the finishing machine shall be placed on the rails and operated over the entire deck as many times as necessary to assure the required depth of concrete and the proper clearances to the reinforcing steel prior to starting the placement.

**3.9.2.3** The finishing machine shall follow closely behind the placing and consolidating operation and the placing and finishing operations shall be continuous. See 3.5.3.1.2.1.

## SECTION 520

**3.9.2.4** All work behind the finishing machine shall be performed from work-bridges. Work-bridges shall have independent movement capability and shall not be attached to the finishing machine. Walking in the concrete behind the finishing machine will not be permitted.

**3.9.2.5** The finished concrete shall have the required crown and grade and the surface shall not vary from either by more than 1/8" in 10 ft. The surface shall have a concrete surface profile (CSP) of 5 or less in accordance with the International Concrete Repair Institute (ICRI) technical guideline for "Selecting and Specifying Concrete Surface Preparation for Sealers, Coatings, and Polymer Overlays" Guideline No. 03732. As soon as the bleeding has stopped or the sheen has started to disappear, the concrete shall be given a final surface finish by scraping or dragging with an approved float at least 3 ft. in length. The float shall be placed on the outer edge of the finished concrete and moved transversely the full width of the deck. The finished edge shall be parallel to centerline. Each subsequent pass shall lap the preceding pass by at least 1/2 the length of the float. Concrete decks that will be the final wearing surface shall receive a pan drag without a float finish. This shall be followed by a broom finish utilizing a broom specifically made for this purpose. Fabric impressions in the surface caused by the texture of water-retaining materials shall not be cause for rejection. Objectionable defects, such as sharp edges caused by cement cream lines or fabric creases, shall be removed by the Contractor.

### 3.10 Curing Concrete.

**3.10.1** All exposed surfaces of concrete, except Class F, Flowable Fill, shall be cured in accordance with the requirements of Table 520-9. All water used to wet cure concrete shall conform to 2.5. Failure to cure concrete by an approved method shall be cause for rejecting the work.

**TABLE 520-9 - CONCRETE CURING**

Type of Construction	Curing Method	Minimum Number of Days Before Membrane Application	
		Horizontal	Vertical
Bridge Decks, approach slabs and overlays	c	per Section 538	per Section 538
Concrete to be treated w/ Item 534	a		
All other concrete except Class F, Flowable Fill	a or b	14	7

Cure Method "a" - Concrete shall be kept moist until it can support curing covers at which time it shall be completely covered with a vapor-proof barrier conforming to 2.6.2. Water shall be reapplied as necessary to keep the surface of the concrete wet for the entire 7 day cure period.

Cure Method "b" - Immediately after finishing, all exposed surfaces shall be treated with a liquid curing compound conforming to 2.6.3 at the rate of 1 gallon per 200 square feet or by fog spray, sprinkling or ponding of water conforming to 2.5 or any combination of the above, when the weather permits. Within 24 hours of finishing, these surfaces shall be completely covered with a vapor-proof barrier conforming to 2.6.2 for the remainder of the 7 days.

Cure Method "c" - The surface shall receive a wet cure utilizing water retaining material for at least 7 days. Water retaining material shall be burlap conforming to 2.6.1, cotton mats conforming to 2.6.4 or other approved water retaining material. Water retaining material shall be kept wet for the entire seven days. Apply water retaining material in accordance with 3.10.2. During the first 24 hours, the water retaining material shall be kept continuously wet by means of an approved automatic sprinkling or wetting system. After 24 hours, the Contractor may cover the wet water retaining material with a 4 mil minimum white polyethylene film for the remainder of the curing period in lieu of using a sprinkling or wetting system although wetting under the polyethylene may be required.

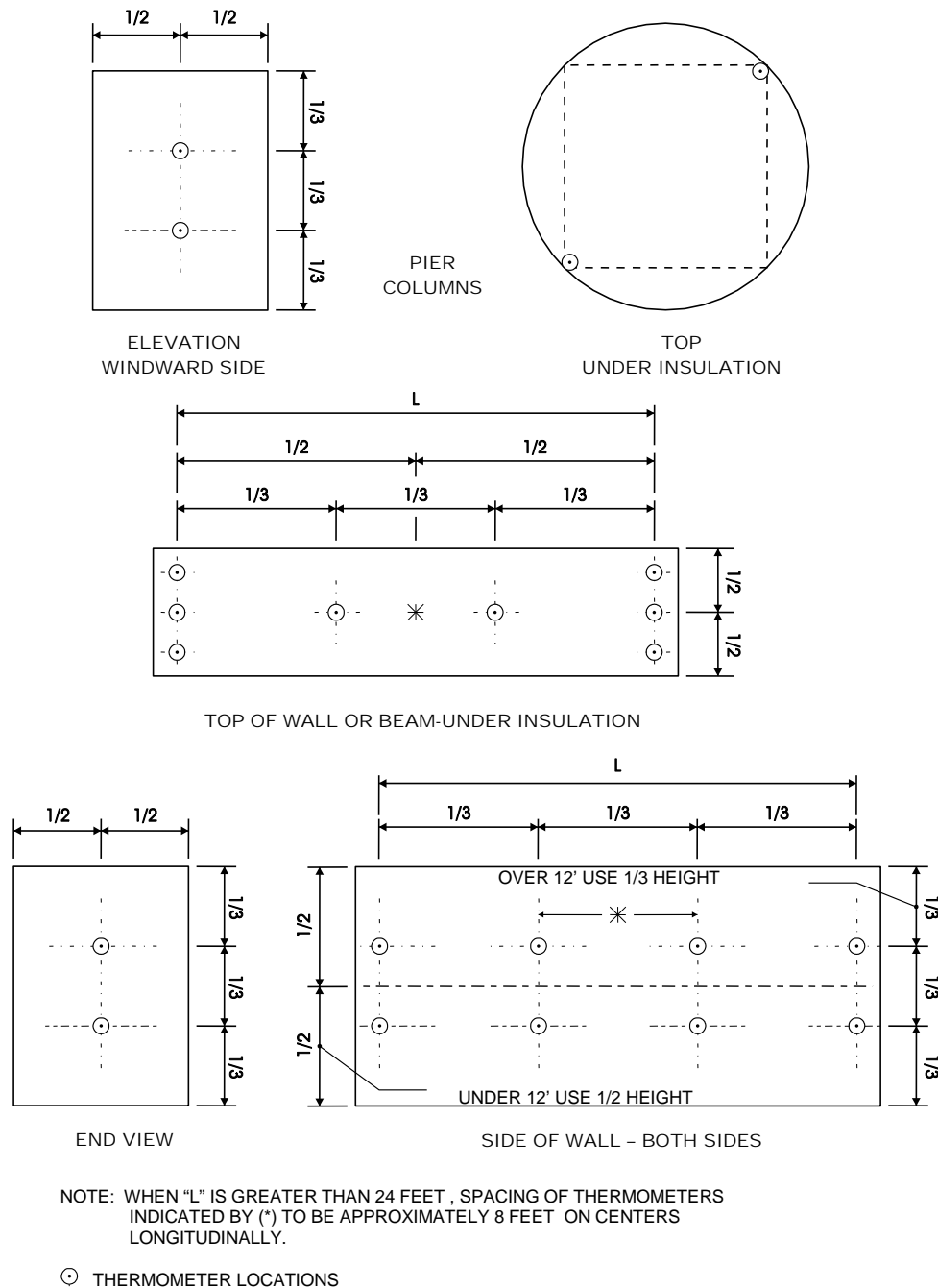

FIGURE 1 - LOCATION OF THERMOMETERS

### 3.10.2 Application of Water Retaining Curing Material.

**3.10.2.1** Burlap shall be applied damp within 30 minutes after concrete has been finished.

**3.10.2.2** Unsized cotton mats shall be applied dry within 10 minutes after concrete is finished and saturated immediately after. Care shall be exercised to ensure that the cotton mats are weighted down adequately to provide continuous contact with the concrete surface.

**3.10.2.3** Other approved water retaining curing material shall be applied in accordance with the manufacturer's recommendations and as approved by the Engineer.

## SECTION 520

### 3.11 Loading Concrete.

#### 3.11.1 Removing Forms.

**3.11.1.1** Unless otherwise permitted, load bearing forms may not be removed until concrete test cylinders have attained 80 percent of the specified design compressive strength. If not controlled by such tests, the following periods may be used as a guide: For load bearing falsework, 14 days; for all other parts, 3 days or as directed. Non-load bearing forms may be removed in order to finish the concrete surface following a minimum 24 hours cure time, when directed by the Engineer.

**3.11.1.2** The provisions of 3.10 shall apply if forms are removed prior to completion of the curing period.

#### 3.11.2 Loading Restrictions.

**3.11.2.1** After the concrete has been placed and the finishing operations concluded, the concrete shall not be walked on or disturbed in any manner, including removal of forms, for a minimum period of 12 hours. If admixtures are present, this minimum period may be adjusted as directed by the Engineer.

**3.11.2.2** Nothing, except as permitted in 3.10.1 shall be placed on the concrete prior to the minimum time periods specified in Table 520-10.

**TABLE 520-10 - CONCRETE LOADING**

Type of Construction	Minimum Requirements before Loading after Placement of Concrete
Substructure concrete, Box Culvert base slabs and Superstructure Concrete*	<ul style="list-style-type: none"><li>Forms for subsequent concrete placements may be placed after 12 hours have elapsed or as adjusted in 3.11.2.1 and the concrete has sufficient strength to allow it to be worked on without damage and proper cure is maintained.</li><li>Field cured test cylinders shall attain 80% of design strength before superimposed loads from subsequent concrete placements are allowed. Alternatively, the Contractor may submit, for approval, details and calculations showing superimposed loads will not damage the previously placed concrete or impeded the proper cure.</li></ul>

\* Superstructure Concrete shall have 100% of design strength for traffic loads.

**3.11.2.3** The peak particle velocity ground vibration limits adjacent to newly placed concrete as specified in [203.3.3.5.5](#) shall apply.

### 3.12 Finishing.

#### 3.12.1 General.

**3.12.1.1** Surface finishes shall be classified as follows:

- Class 1, Ordinary Finish
- Class 2, Rubbed Finish

**3.12.1.2.** Forms may be removed in accordance with 3.11.1.1. If the required curing period has not been completed for a surface being finished, only the portion of the surface actually being finished shall be exposed, and curing will be immediately re-established once the phase of finishing underway has been completed.

All exposed concrete surfaces shall be given a Class 1, Ordinary Finish. If a Class 2 or other finish is required, it shall be as specified by the Plans, Supplemental Specifications, or Special Provisions for designated surfaces.

**3.12.1.3 Class 1, ordinary finish.** Fins and projections shall be removed from all surfaces except those which will not be exposed. On all exposed surfaces the cavities produced by form ties, honeycomb spots, broken corners or edges, and all other holes and defects shall be thoroughly cleaned and saturated with water for not less than 3 hours. These areas shall then be carefully pointed and trued with a mortar composed of the same brand of cement and fine aggregate mixed in the proportions of the concrete being finished. Mortar used in pointing shall not be more than 1 hour old. The mortar patches shall be cured as specified in 3.10. All expansion joints in the completed work shall be left carefully tooled and free of mortar. The joint fillers shall be left exposed for their full length with clean, true edges. Holes which will not be exposed may be filled with asphalt cement when permitted.

**3.12.1.4 Class 2, rubbed finish.** After removal of forms, holes and imperfections shall be filled with mortar conforming to 3.12.1.3. After the mortar has thoroughly set, the concrete shall be saturated with water for at least 3 hours. The concrete shall be kept continuously wet at all times during finishing. The surfaces shall then be rubbed with a medium coarse Carborundum stone and a small amount of mortar until all voids have been filled and all marks and projections have been removed and the surface is uniform. This surface shall be left until all concrete to be rubbed above it has been similarly treated.

**3.12.1.4.1** After all concrete surfaces have received their initial rubbing, the next procedure shall consist of rubbing the concrete with fine Carborundum stone and water until a smooth uniform texture is obtained.

**3.12.1.4.2** The final procedure shall consist of rubbing the concrete with dry burlap to remove loose powder. Should the final surface be unsatisfactory, a repetition of the above procedures will be required. The final surface shall have been achieved by altering the original concrete surface; a surface coating of cementitious material which adds thickness to the original surface is not acceptable.

**3.12.1.5** All shrinkage cracks shall be treated as directed by the Engineer.

### **3.12.2 Method Requirements.**

**3.12.2.1** All copings shall receive a Class 2, Rubbed Finish. Exposed concrete surfaces containing imperfections shall be given a Class 2 finish or treated in some other manner approved by the Engineer. All other surfaces shall receive a Class 1 finish.

### **3.12.3 Performance Requirements (QC/QA).**

**3.12.3.1** All concrete copings and all other concrete surfaces shall receive a Class 1 finish unless otherwise specified.

## **Methods of Measurement**

**4.1** Concrete class AAA, AA, A, B, T and F will be measured by the cubic yard in place unless otherwise indicated, and in accordance with the following.

**4.1.1** Except as specified below, the volume will be computed to the nearest 0.1 cubic yard by the prismatic method using the dimensions as shown on the plans or as ordered. No allowance or measurements will be made for materials not entering permanently into the work or those used without proper authorization. No deductions will be made for the volume of concrete displaced by steel reinforcement, structural steel, expansion joint materials, scuppers, weepers, conduits, or the tops of piles.

**4.1.1.1** Concrete Class T will be measured to the neat lines as shown on the plans. Seals on ledge will be measured to the ledge limit ordered to be removed.

**4.1.1.2** When the Engineer determines that it is impracticable to measure the volume by dimensions, the volume will be based on the actual yield as determined in the field in accordance with AASHTO T 121.

**4.1.1.3** Concrete Class B, footings (on rock) will be measured to the form lines placed at the limits shown on the plans. All concrete class B, footings (on rock) where rock will not be removed shall be formed and measured in accordance with 4.1.1.2.

**4.2** Concrete class AAA; AA; A, Above Footings; A, Culverts; B, Footings and concrete bridge deck of the type specified will not be measured, but shall be the cubic yard final pay quantity in accordance with 109.11 for material required within the limits shown on the plans.

**4.3** Concrete for bridge deck overlay will be measured by the cubic yard to the nearest 0.1 cubic yard based on surface area multiplied by the specified depth.

## **Basis of Payment**

**5.1** The accepted quantities of concrete class AAA, AA, A, B, T and F will be paid for at the Contract unit price per cubic yard complete in place, unless otherwise indicated.

**5.1.1** The cost of development and testing of alternate mix designs for concrete class F, flowable fill will be subsidiary to the item.

**5.2** Concrete class AAA; AA; A, above footings; A, culverts; B, footings and concrete bridge deck of the type specified are final pay quantity items and will be paid for at the Contract unit price per cubic yard in accordance with 109.11.

### **5.3 Foundation Seal.**

**5.3.1** Seals shown on the plans will be paid for at the Contract unit price per cubic yard for Item 520.6.

**5.3.2** Seals ordered, but not shown on the plans, will be paid for at the Contract unit price per cubic yard for Class T concrete if Class T is included in the proposal.

**5.3.3** Seals requested by the Contractor and permitted, but not deemed necessary, will not be paid for.

**5.4** Waterproofing of construction joints shown on the plans or ordered will be paid for under Section 538.

**5.5** Waterstops will be paid for under Section 541.

**5.6** Reinforcing steel will be paid for under Section 544.

**5.7** Weepers and concrete admixtures will be subsidiary.

**SECTION 520**

**5.8** The accepted quantity of concrete for bridge deck overlay will be paid for at the Contract unit price per cubic yard complete in place.

**5.8.1** Overlay materials rejected shall be removed and replaced by the Contractor at no additional cost to the Department.

**5.8.2** Sawcutting concrete for bridge deck overlays as required by 3.5.8.2.3 shall be subsidiary.

**5.9 Performance Requirements – QC/QA Pay Adjustments.**

**5.9.1** Pay adjustments will be paid based on Unit Price (UP), pay adjustment factors as specified below, and the total quantity computed from all accepted delivery records. The UP will be the Contract unit price per cubic yard for the class of concrete involved. Where payment is on a final pay quantity basis, the UP for determining pay adjustments shall be determined by the following method. Multiply the Contract final pay quantity (adjusted Contract final pay quantity, if field changes have been made) by the unit price bid for the item, then divide the result by the total quantity computed from all accepted delivery records for the class of concrete being evaluated.

**5.9.1.1** For QC/QA Concrete Class A and Class B, no negative pay factors will be assessed when all test results meet the requirements for each class contained in Section 520 however, all provisions of 3.1.6.3.7.1 shall apply.

**5.9.1.2** The maximum and minimum percentage pay factors payable under this specification are as follows:

Class AA	+7%	to	-25%
Class A	+2%	to	-10%

**5.9.2** Concrete with non-conforming strength represented by an acceptance test per subplot will be subject to the following pay adjustment:

$$\text{Pay Factor (for strength in psi)} = 1 + 0.0005(f'ca - f'c)$$

$$\text{Pay Factor (for strength in MPa)} = 1 + 0.0725 (f'ca - f'c)$$

Where: f'ca = actual compressive strength at 28 days

f'c = specified compressive strength at 28 days

$$\text{Sublot Pay Adjustment} = (\text{Pay Factor} - 1) \times \text{Sublot Size} \times \text{U.P.}$$

Concrete strength greater than the specified compressive strength is not eligible for bonus pay.

**5.9.3** Concrete with surface resistivity represented by a test value for the subplot will be subject to a pay factor determined in accordance with the following schedule rounded to 2 decimal places:

Class AA Permeability Index Resistivity (kΩ-cm)	Pay Factor
≥5 and ≤10	1.05 – 0.06 (10 – SRT)
>10 and ≤35	1.05
>35 and ≤150	1.0 + 0.0004347 (150 – SRT)
>150	1.0

SRT = surface resistivity test in kΩ-cm

**5.9.3.1** When the surface resistivity for any subplot is less than the lower specification limit as shown in Table 520-1, the concrete for that subplot will be rejected and subject to the provisions of 106.03.2.2.

**5.9.4** A pay factor each for air content and water cement ratio will be calculated in accordance with 106.03.2.4.

**5.9.5 Concrete Cover**

**5.9.5.1** For calculating the pay factor for concrete cover, measurements will be obtained from a radar rebar depth measuring unit and recorded to the nearest 1/8” Each measurement will be converted into a number (x) that represents a percentage of the tolerance as listed in Table 520-1 with a negative number being below target value and a positive number being above target value. The following formula will be used for calculating each x value:

$$x = \frac{(R - TV)}{T}$$

where R = Result obtained from radar unit readings.  
 TV = Target value from Plans.  
 T = Tolerance from Table 520-1.

The x values over the entire lot will be evaluated together for a pay factor in accordance with 106.03.2.4 with USL = 1.00 and LSL = (-1.00).

**5.9.5.2 Bridge Decks and Rail Support Slabs.** In cases where the concrete cover is excessive such that the pay factor is calculated to be between 0.75 and 0.99 inclusive and the percent within the lower specification limit (P<sub>L</sub>) is 100%, the Contractor may submit calculations that show a live load rating greater than or equal to the design load for the deck or slab. These calculations shall be based on the materials strengths stated in the plans; a “d” based on the 95<sup>th</sup> percentile cover measurement and shall follow an approved traditional method of analysis. If the calculations are accepted as correct by the Engineer, the negative pay adjustment for excess cover will be multiplied by 0.25. If the calculations are not accepted, all provisions of the specification regarding pay factors will remain in effect. If the concrete cover is excessive to the point where a failed condition results and all of the above conditions are met, the resultant pay factor shall be 0.93.

**5.9.5.3** Negative pay adjustments for concrete cover will be multiplied by 0.25 for decks constructed in phases. All provisions of 3.1.6.3.7.2 shall apply. Pay adjustment provisions for decks constructed in phases shall not be used in conjunction with pay adjustment provisions in 5.9.5.2. If concrete cover on decks constructed in phases is excessive to the point where a failed condition results, the resultant pay factor will be 0.93.

**5.9.5.4 Pedestrian Sidewalks.** In the case where concrete cover is excessive such that the pay factor is calculated to be less than 1.0 and the Percent Within Lower Specification Limit (PL) 100%, the pay factor will be 1.0.

**5.9.5.5 At Grade Approach Slabs.** In cases where concrete cover is excessive such that the pay factor is calculated to be between 0.75 and 0.99 inclusive and the Percent Within Lower Specification Limit (PL) 100%, the negative pay adjustment for excess cover will be multiplied by 0.25. If concrete cover is excessive to the point where a failed condition results and all of the above conditions are met, the resultant pay factor will be 0.93.

**5.9.6** Once the pay factors for permeability, air content, water cement ratio, and concrete cover are determined, the following Table 520-11 and equations will be used to calculate an individual pay adjustment for each measured characteristic.

**Table 520-11 - Weight Factor**

Measured Characteristic	Weight Factor “f”		
	Class AA	Class A	Class B
Permeability	0.40	0.00	0.00
Air Content	0.40	0.40	0.20
Water/Cement Ratio	0.20	0.20 <sup>(1)</sup>	0.40 <sup>(1)</sup>
Concrete Cover	0.40	0.40 <sup>(1)</sup>	0.40 <sup>(1)</sup>

<sup>(1)</sup> This will be assigned a pay factor (PF) of 1.00

## SECTION 520

The pay adjustment for each measured characteristic per lot (per subplot for permeability) will be determined by the following equations:

$$\text{For Pay Factors } \geq 1.0: \text{ PA}_i = (\text{PF}_i - 1)f_i(Q)(\text{UP})$$

$$\text{For Pay Factors } < 1.0: \text{ PA}_i = (\text{PF}_i - 1) \frac{f_i}{\sum f} (Q)(\text{UP})$$

where:  $\text{PA}_i$  = Pay adjustment payment in dollars for each characteristic.  
 $\text{PF}_i$  = Pay factor or composite pay factor for each characteristic.  
 $f_i$  = Weight factor from Table 520-6 for each characteristic.  
 $\sum f$  = Sum of weight factors.  
 $Q$  = Quantity computed from all accepted delivery records for the lot (subplot for permeability).  
 $\text{U.P.}$  = Unit price as defined in 5.9.1.

### Pay items and units:

520.__	Concrete Class __, _____ (F)*	Cubic Yard
520.___02	Concrete Class __, _____ (QC/QA)(F)	Cubic Yard
520.001	Concrete Class AAA	Cubic Yard
520.01	Concrete Class AA	Cubic Yard
520.0202X	Concrete Class AA, Rail Support Slab (QC/QA) (F)	Cubic Yard
520.02	Concrete Class AA, Above Footings (F)	Cubic Yard
520.0302X	Concrete Class AA Approach Slabs (QC/QA) (F)	Cubic Yard
520.1	Concrete Class A	Cubic Yard
520.12	Concrete Class A, Above Footings (F)	Cubic Yard
520.2	Concrete Class B	Cubic Yard
520.211	Concrete Class B, Footings (On Rock)	Cubic Yard
520.213	Concrete Class B, Footings (On Soil) (F)	Cubic Yard
520.421	Concrete Class F, Flowable Fill, Excavatable	Cubic Yard
520.6	Concrete Class T, Foundation Seal	Cubic Yard
520.7	Concrete Bridge Deck (F)	Cubic Yard
520.7X02	Concrete Bridge Deck (QC/QA)(F)	Cubic Yard
1010.4X	Quality Control/Quality Assurance (QC/QA) for Concrete	\$

\* Some of these items may not be a final pay quantity item.



## APPENDIX A

**NHDOT MICROWAVE PROCEDURE  
FOR WATER/CEMENT RATIO**

1. Tare microwave safe container.
2. Place sample of 2000  $\pm$ 300 grams of concrete in container.
3. Weigh sample in container to nearest gram.
4. Place sample in container into microwave oven at 50% power for one half hour.
5. Weigh container and sample to nearest gram.
6. Place into microwave oven at 50% power for ten minutes.
7. Weigh to nearest gram.
8. Repeat steps 6 & 7 until constant weight is achieved.
9. Calculate Water/Cement (W/C) ratio with the following formula:

$$W/C = (N+1) MD - N \{ACA (1-FA) + AFA (FA)\}$$

Where: MD =  $\frac{\text{WET WT.} - \text{DRY WT.}}{\text{DRY WT.}}$  (Concrete Sample)

$$N^* = \frac{\text{TOTAL AGGREGATE}}{\text{CEMENT}}$$

FA\* = RATIO OF SAND TO TOTAL AGGREGATE (DECIMAL)

ACA = ABSORPTION OF COARSE AGGREGATE (DECIMAL)

AFA = ABSORPTION OF FINE AGGREGATE (DECIMAL)

\* Use Actual Batch Weights, not Mix Design

APPENDIX B  
 CONCRETE EVAPORATION RATE CHARTS

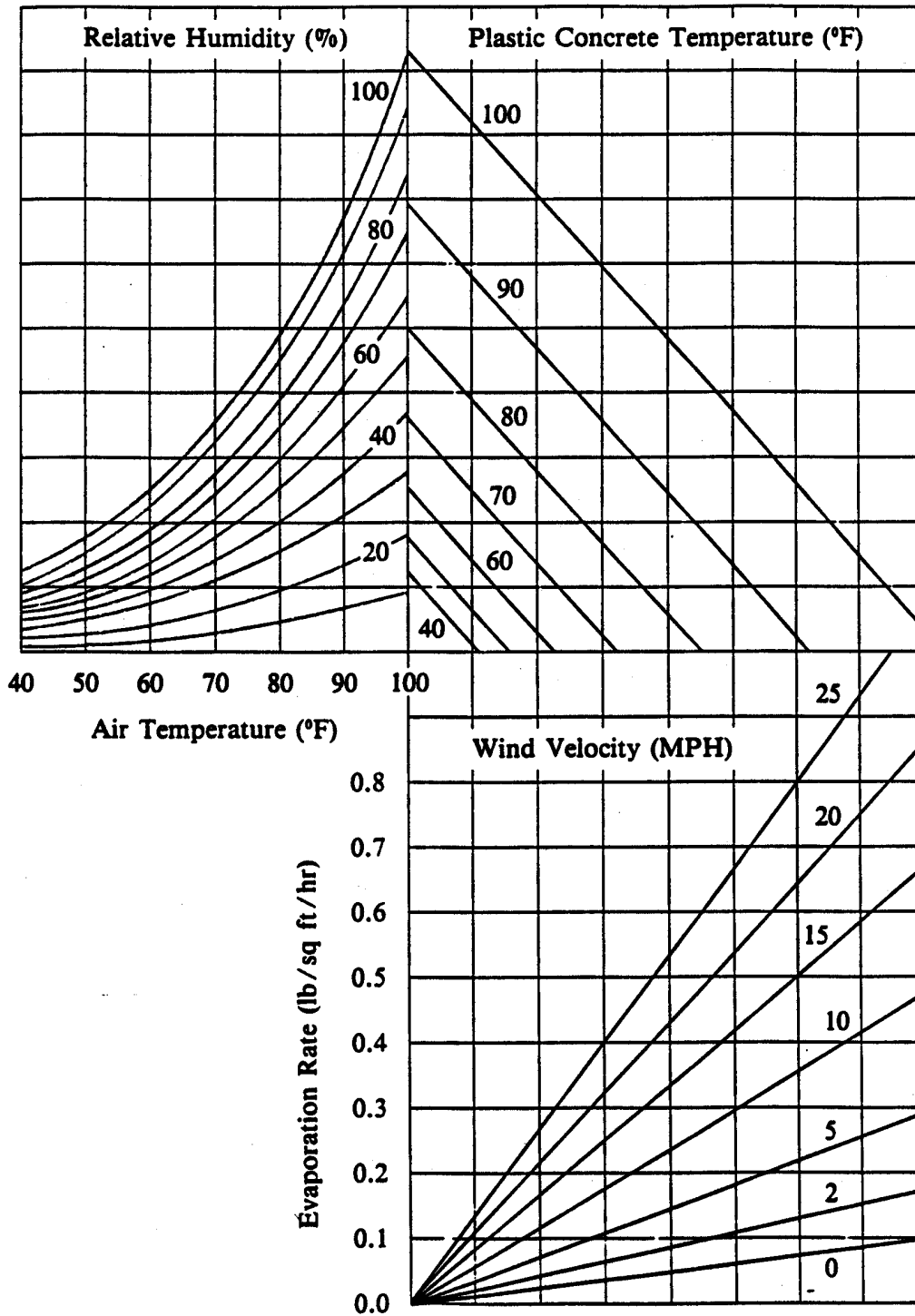

## APPENDIX C

## EXAMPLE CALCULATIONS FOR PAY ADJUSTMENT

## STEP 1 - STATEMENT OF CONDITIONS AND FIELD TEST RESULTS:

- A) Bid price of the Concrete Class AA (QC/QA) item is \$373.89/CY, which is also the Unit Price of Concrete (see 520.5.2). The accepted quantity from the delivery records is 337 CY.
- B) All samples are to be taken on a statistically random basis with lot sizes based approximately on those values listed in the Acceptance Guidelines adjusted as required to meet field situations.

Lot	Date	Location	Day's Placement (CY)
1	June 15, 1998	Phase 1 Deck	162
2	June 25, 1998	Phase 1 Sidewalk	14
3	Aug. 25, 1998	Phase 2 Deck	148
4	Sept. 4, 1998	Phase 2 Sidewalk	13
<b>Total =</b>			<b>337</b>

- C) **Strength.** Cylinder design strength is 4000 psi. Strengths will be the average of two cylinders per subplot broken at 28 days. The strength pay factor is not eligible for an incentive pay adjustment.

Lot	Day's Placement (CY)	Sublot Number	Sublot Size (CY) (See 520.3.1.6.3.2)	Cylinder Strength (PSI)
1	162	1-1	54	7173
1		1-2	54	3770
1		1-3	54	7720
2	14	2-1	14	6970
3	148	3-1	49.33	5150
3		3-2	49.33	6260
3		3-3	49.34	3958
4	13	4-1	13	6580

- D) **Permeability.**

Lot	Day's Placement (CY)	Sublot Number	Sublot Size (CY)	Permeability Index (kΩ-cm)
1	162	1-1	54	29
1		1-2	54	36.5
1		1-3	54	85
2	14	2-1	14	32
3	148	3-1	49.33	40
3		3-2	49.33	37
3		3-3	49.34	8.5
4	13	4-1	13	7

**SECTION 520**

**E) Concrete air content.**

Lot	Day's Placement (CY)	Sublot Number	Sublot Size (CY)	Air Content %
1	162	1-1	54	7.5
1		1-2	54	8.6
1		1-3	54	8.2
2	14	2-1	14	6.4
3	148	3-1	49.33	6.3
3		3-2	49.33	7.9
3		3-3	49.34	5.2
4	13	4-1	13	9.0

**F) Water/Cement ratio.**

Lot	Day's Placement (CY)	Sublot Number	Sublot Size (CY)	Water/Cement Ratio
1	162	1-1	54	0.373
1		1-2	54	0.382
1		1-3	54	0.401
2	14	2-1	14	0.424
3	148	3-1	49.33	0.429
3		3-2	49.33	0.390
3		3-3	49.34	0.361
4	13	4-1	13	0.377

**G) Concrete cover.** Cover is measured according to the provisions of 520.5.9.5 from the concrete surface to the closest reinforcing member. Only 6 results shown for illustration purposes.

Lot	Location (Sta. to Sta.)	Cover (R)	Value (x)
3	Phase 2 Bridge Deck	2 1/4"	-0.50
		2 1/8"	-0.75
		2 1/2"	+0.00
		2 1/4"	-0.50
		2 5/8"	+0.25
		2 1/8"	-0.75

**STEP 2 - CALCULATION OF PAY ADJUSTMENT**

**A) Strength Pay Adjustments:** Pay Factor (for strength in psi) =  $0.0005 (f'_{ca} - f'_c)$

Lot	Sublot Number	Cylinder Strength f 'ca (PSI)	Pay Factor	Sublot Size (CY)	Unit Price (\$/CY)	Sublot Pay Adjust (\$) (PF x CY. x UP)	Cumulative Adjust (\$)
1	1-1	7173	0.000	54	373.89	0.00	0.00
1	1-2	3770	-0.115	54	373.89	-2,321.86	-2,321.86
1	1-3	7720	0.000	54	373.89	0.00	-2,321.86
2	2-1	6970	0.000	14	373.89	0.00	-2,321.86
3	3-1	5150	0.000	49.33	373.89	0.00	-2,321.86
3	3-2	6260	0.000	49.33	373.89	0.00	-2,321.86
3	3-3	3958	0.000	49.34	373.89	0.00	-2,321.86
4	4-1	6580	0.000	13	373.89	0.00	-2,321.86

## COMMENTS:

As per 3.1.6.3.7.1, sublots with test results that are within minus 60 psi of, or higher than, the design strength will not be pay adjusted, but will be paid for at 100% of the Item Bid Price. All concrete sublots with strengths of more than 500 psi below the mix design strength will be rejected by the Engineer.

Note that all values in the Lots, except one, are within the -60 psi limit.

B) **Permeability Pay Adjustments:** See 5.9.3 for pay factor equations.

Lot	Sublot Number	Permeability Index (kΩ-cm)	Pay Factor	Sublot Size (CY)	Unit Price (\$/CY)	Sublot Pay Adjust (\$) (See 5.9.6)	Cumulative Adjust (\$)
1	1-1	29	1.05	54	373.89	\$403.80	\$403.80
1	1-2	36.5	1.05	54	373.89	\$403.80	\$807.60
1	1-3	85	1.03	54	373.89	\$242.28	\$1,049.88
2	2-1	32	1.05	14	373.89	\$104.69	\$1,154.57
3	3-1	40	1.05	49.33	373.89	\$368.88	\$1,523.45
3	3-2	37	1.05	49.33	373.89	\$368.88	\$1,892.33
3	3-3	8.5	0.96	49.34	373.89	\$-210.83	\$1,681.50
4	4-1	7	0.87	13	373.89	\$-180.54	\$1,500.96

COMMENTS: As per 5.9.3 Pay Factors will be rounded to 2 decimal places.

C) **Air Content Pay Adjustments:** Lot 2 result shall be evaluated with Lot 1 and Lot 4 shall be evaluated with Lot 3 per 3.1.6.3.2. See also 5.9.4 for pay factor formula.

Lot/ Lot Size	Upper Spec Limit (USL)(%)	Lower Spec Limit (LSL)(%)	Sublot Test Results				Avg. (x)	Standard Deviation (s)
1 & 2			1-1	1-2	1-3	2-1		
176	9	5	7.5	8.6	8.2	6.4	7.675	0.964
3 & 4			3-1	3-2	3-3	4-1		
161	9	5	6.3	7.9	5.2	9.0	7.100	1.683

Lot	Upper Quality Index (QU)	Lower Quality Index (QL)	% Within Upper Limits (PU from Table 106-1, n=4)	% Within Lower Limits (PL from Table 106-1, n=4)	Quality Level (QL)	Pay Factor (from Table 106-2)
1 & 2	1.37	2.77	96	100	96	1.04
3 & 4	1.13	1.25	88	92	80	1.02

Pay Adjustment (Lots 1 & 2) = (PF-1) x f x CY. x UP = 0.04 x 0.40 x 176 x \$373.89 = \$1052.87

Pay Adjustment (Lots 3 & 4) = (PF-1) x f x CY. x UP = 0.02 x 0.40 x 161x \$373.89 = \$481.57

**SECTION 520**

D) Water/Cement Ratio Pay Factor Determination: USL is  $x+0.030$  and LSL is  $x-0.030$ .

Lot/ Lot Size	Upper Spec Limit (USL)(%)	Lower Spec Limit (LSL)(%)	Sublot Test Results				Avg. (x)	Standard Deviation (s)
			1-1	1-2	1-3	2-1		
1 & 2								
176	0.425	0.365	0.373	0.382	0.401	0.424	0.395	0.023
3 & 4								
161	0.419	0.359	0.429	0.390	0.361	0.377	0.389	0.029

Lot	Upper Quality Index (QU)	Lower Quality Index (QL)	% Within Upper Limits (PU from Table 106-1, n=4)	% Within Lower Limits (PL from Table 106-1, n=4)	Quality Level (QL)	Pay Factor (from Table 106-2)
1 & 2	1.30	1.30	94	94	88	1.03
3 & 4	1.03	1.03	85	85	70	0.98

Pay Adjustment (Lots 1 & 2) =  $(PF-1) \times f \times CY \times UP = 0.03 \times 0.20 \times 176 \times \$373.89 = \$394.83$

Pay Adjustment (Lots 3 & 4) =  $(PF-1) \times f \times CY \times UP = -0.02 \times 0.20 \times 161 \times \$373.89 = -\$240.79$

E) **Concrete Cover Pay Factor Determination:** See 5.9.5. Assume for this example 450 readings were taken from the phase 1 deck and sidewalk surfaces with an overall x value of -0.30 and a standard deviation of 0.411 as determined by the radar depth measuring unit.

Lot	Lot Size	Upper Spec Limit (USL)	Lower Spec Limit (LSL)	Avg. (x)	Standard Deviation (s)
1&2	450	1.00	-1.00	-0.30	0.411

Upper Quality Index (QU)	Lower Quality Index (QL)	% Within Upper Limits (PU from Table 106-1, n>200)	% Within Lower Limits (PL from Table 106-1, n>200)	Quality Level (QL)	Pay Factor (from Table 106-2)
3.16	1.70	100	96	96	1.02

Pay Adjustment (Lots 1&2) =  $UP \times (PF-1) \times CY \times f = \$373.89 \times 0.02 \times 176 \times 0.40 = \$526.44$

Assume that the phase 2 deck and associated sidewalk yield a 0.99 pay factor:

Pay Adjustment (Lots 3&4) =  $UP \times (PF-1) \times CY \times f = \$373.89 \times -0.01 \times 161 \times 0.40 = -\$240.79$

**STEP 3 – TOTAL PAY ADJUSTMENT:**

<b>Strength Pay Adjustment</b>	-\$2,321.86
<b>Permeability Pay Adjustment</b>	\$1,500.96
<b>Air Content Pay Adjustment (Lots 1&amp;2)</b>	\$1,052.87
<b>Air Content Pay Adjustment (Lots 3&amp;4)</b>	\$481.57
<b>Water/Cement Ratio Pay Adjustment (Lots 1&amp;2)</b>	\$394.83
<b>Water/Cement Ratio Pay Adjustment (Lots 3&amp;4)</b>	-\$240.79
<b>Concrete Cover Pay Adjustment (Lots 1&amp;2)</b>	\$526.44
<b>Concrete Cover Pay Adjustment (Lots 3&amp;4)</b>	-\$240.79
<b>Total Class AA Pay Adjustment (Item 1010.4X) =</b>	<b>\$1,153.23</b>

NOTE: Pay adjustments may be calculated for each estimate based on all test results to date.

ROUNDING NOTE: Target values and results are rounded to the same places as the specification.  
Average ( $\bar{x}$ ) and standard deviation ( $s$ ) are not rounded.  
Pay factors,  $Q_U$ , and  $Q_L$  are rounded to 2 places in all cases.

**SECTION 528 -- PRESTRESSED CONCRETE MEMBERS****Description**

**1.1** This work shall consist of manufacturing, storing, transporting, and erecting, precast, pre-tensioned, concrete I-girders, bulb-tee girders, box beams, butted deck beams, and deck panels herein referred to as “members”, in accordance with the Contract plans. The relevant provisions of the AASHTO LRFD Bridge Construction Specifications shall be adhered to unless such provisions are in conflict with this specification. This specification includes provisions for high performance concrete and alkali-silica reactivity.

**1.1.1** This work shall also include the installation of grout and the application of transverse post-tensioning where indicated on the plans.

**Materials**

**2.1 Cement.** Portland cement shall be Type II or III conforming to AASHTO M 85 or M 240, as appropriate.

**2.1.1** All cement used in the manufacture of the members in any one structure shall be the same brand, type and color, unless otherwise permitted.

**2.2 Aggregate.** Aggregate shall conform to the requirements of 520.2.2. The coarse aggregate gradation shall be as specified for Concrete Class AA in Section 520.

**2.3 Admixtures.** Admixtures shall conform to the requirements of 520.2.3.

**2.4 Prestressing Steel.**

**2.4.1** Prestressing steel shall be uncoated, seven-wire strand, conforming to the requirements of AASHTO M 203 Grade 270 low-relaxation.

**2.4.2** The Fabricator shall furnish certified copies of a representative load-elongation curve test report for each size and grade of strand, for lots of 10 tons or fraction thereof.

**2.4.3** The Fabricator shall furnish a certified mill test report for each heat and coil of wire used in the production of the strand.

**2.4.4** Each manufactured reel of prestressing steel strand to be shipped shall be assigned an individual lot number and clearly tagged for accurate identification. Such identification shall not be removed from the reel or strand until the reel is entirely used or until end-use fabrication has been completed.

**2.5 Reinforcing steel.** Reinforcing steel shall conform to the requirements of 544.2.

**2.6 Wire Fabric.** Welded deformed steel wire fabric shall conform to the requirements of AASHTO M 221M.

**2.7** Storage of concrete materials shall conform to the requirements of 520.2.10.

**2.8 Concrete.**

**2.8.1** Concrete shall be controlled, mixed, and handled as specified in the pertinent portions of Section 520 unless otherwise specified herein.

**2.8.2 Mix Design.** The Fabricator shall design and submit for approval the proportions and test results for a concrete mix which shall attain the following: a minimum design compressive strength as detailed on the plans for test cylinders sampled in accordance with the requirements of AASHTO T 141, molded and cured in accordance with the requirements of AASHTO T 23, and tested in accordance with the requirements of AASHTO T 22; a surface resistivity greater than 15 kilohm-centimeter ( $k\Omega\text{-cm}$ ) at 56 days using AASHTO TP 95. The minimum average compressive strength of the proposed mix shall be determined using the procedures in Appendix D. Air entrainment shall be targeted at a value of 6.0 percent  $\pm$  1.5 percent. Testing shall be in accordance with AASHTO T 119 and T 152.

**2.8.2.1** Sixty (60) days prior to the start of member fabrication, the mix design shall be submitted to the Bureau of Materials and Research for approval. No concrete shall be placed within the forms until the concrete mix design is approved.

**2.8.2.2** The Fabricator shall supply laboratory test reports that contain data on the mineralogy and potential reactivity for all aggregates being used in the concrete mix. All aggregates shall be tested in accordance with the requirements of AASHTO T 303 to determine alkali-silica reactivity. The laboratory supplying the test results shall provide evidence that the laboratory is properly equipped and qualified to perform the test methods. All test results submitted for alkali-silica reactivity shall be from tests conducted within one calendar year from the date the mix design is submitted to the Department.

**2.8.2.3** Mix designs using potentially alkali reactive aggregates shall include mitigation for reactivity and shall be submitted to the Department for approval. Mitigation of potentially reactive aggregates shall consist of one or more of the following methods: use of low alkali cement (less than 0.6 percent  $\text{Na}_2\text{O}$  equivalent); use of a mineral admixture; or use of a chemical admixture. The



proposed mitigation method will be accepted for use after the NHDOT Bureau of Materials and Research reviews test results supplied by the Contractor that show the effectiveness of the mitigation. An effective mitigation technique should reduce the mean expansion to below 0.10% for alkali-silica reactivity when tested in accordance with AASHTO T303.

**2.8.2.4** Should a change in sources of material be made, a new mix design shall be established and approved prior to incorporating the new material. When unsatisfactory results or other conditions make it necessary, the Engineer will require a new mix design.

**2.8.3** All concrete used in precast prestressed members shall contain corrosion inhibitor as shown on the [Qualified Products List](#), Section 520. Corrosion inhibitor shall be used at the rate recommended by the manufacturer.

## **2.9 Shear Key Grout for Butted Beams.**

**2.9.1** Grout for shear keys shall be an approved grout as listed the [Qualified Products List](#). Additional aggregates shall not be added to the material during field mixing.

**2.9.2** The average compressive strength of the 3 cubes at 7 days shall be a minimum of 6000 psi. When tested, 3 neat 2" cubes shall be molded and cured in accordance with AASHTO T 106 (ASTM C 109).

**2.9.3** The grout when thoroughly mixed shall be readily pourable so that it completely fills the shape of the shear key joint.

**2.9.4** The Contractor shall submit a premixed name brand to the Engineer for approval.

**2.10** Temporary supports/grout dams for precast deck panels shall consist of continuous, high-density, expanded polystyrene strips (grout dam) with a minimum compressive strength of 55 psi. If leveling screws are used, a 1.7 pound per cubic foot polyethylene foam seal shall be used as a grout dam.

## **Construction Requirements**

### **3.1 General.**

**3.1.1** Design stresses are closely controlled, however, the behavior in service depends upon the specified concrete being properly placed in forms of the correct dimensions around accurately positioned prestressed strand.

**3.1.2 Specifications.** Fabrication, transportation and erection of prestressed concrete members shall conform to the requirements of the AASHTO LRFD Bridge Construction Specifications, Section 8-Concrete Structures and Section 10-Prestressing, and PCI MNL-116, Manual for Quality Control for Plants and Production of Precast and Prestressed Concrete Products, except as modified by this special provision. In the case of conflicting specifications, the most stringent shall apply.

**3.1.3 Approval.** Prior to performing any work under 528, the Contractor must have received approval for all shop drawings and any special Contract requirements. The Contractor shall bear full responsibility and costs for all materials ordered or work performed prior to approval of the shop drawings or written authorization from the Engineer.

### **3.1.4 Special Contract Requirements.**

**3.1.4.1 Pre-Placement Meeting.** At the request of the Engineer, a pre-placement meeting will be scheduled to review the specification, the schedule, and discuss any special requirements. The meeting will be held at least forty-five (45) days prior to the scheduled casting of any member or test section. The Contract Administrator shall schedule the meeting and invite representatives of the Contractor, Fabricator and the Bureaus of Bridge Design and Materials and Research, along with any other party the Engineer deems appropriate.

**3.1.4.2 Sure Cure System.** The Fabricator shall utilize the Sure Cure Cylinder Mould System, or approved equivalent system, to temperature match cure test cylinders sampled in accordance with AASHTO T 141, molded in accordance with AASHTO T 23 and tested in accordance with AASHTO T 22 for use in verifying concrete compressive strength at release ( $f'_{ci}$ ), design compressive strength ( $f'_c$ ) for acceptance and concrete permeability in all member types. Verification that the system is operating properly shall be supplied to the Department once every 12 months. Documentation shall confirm that the system heats the molds only when they are colder than the internal girder temperature.

**3.1.4.2.1** Match cured cylinders shall be produced using the sure cure system. The cylinders shall be connected to the system's temperature matching controller for the initial curing period. Once the members are stripped and detensioned or the test section stripped, the cylinders shall be subsequently stripped from their molds and stored alongside the member or the test section until they are scheduled to be tested.

**3.1.4.2.2** The system's reference thermocouple shall be located in the center of the bottom bulb. of the girder section, or as otherwise directed by the Engineer in other member types. The thermocouple extension wire shall protrude up out of the member and shall be connected to the system's temperature matching controller.

Thermocouples shall be placed as follows:

## SECTION 528

- For members longer than 50 ft. in length, one thermocouple shall be placed in each member cast.
- For members less than 50 ft. in length, one thermocouple shall be placed in each 12 cy. of product (i.e. 3 thermocouples shall be installed for a placement with 30 cy. of concrete). A minimum of 1 thermocouple shall be placed in each bed cast.

### 3.1.4.3 Test Section.

**3.1.4.3.1** At least thirty (30) days prior to member fabrication, a test placement [10 ft. in length] of the actual member section (unreinforced) shall be poured utilizing the proposed methods of concrete placement and curing. The air entrainment target value of 5 percent shall be held as an absolute minimum value for the test section. Concrete not meeting the air content target value shall not be incorporated into the test placement. Slump as required per 2.8.2 shall be maintained.

**3.1.4.3.2** The Fabricator shall submit to the Bureau of Materials & Research results of temperature match cured cylinders (a set of two, averaged to comprise one strength test) tested for strength at the following intervals as a minimum (15 hours, 24 hours, 3 days, 7 days, and 28 days) for determination of a strength versus time plot for the test placement section.

**3.1.4.3.3** The Fabricator shall obtain two cores in accordance with AASHTO T 24 from the web of the girder test section, or other location determined by the Engineer, and test them for design compressive strength at 28 days (or other time interval to attain design compressive strength as detailed on the plans) to verify the in place concrete strength of the test section. The cores shall be taken no earlier than two days prior to conducting the actual test. Results of the core strength tests shall be submitted to the Bureau of Materials & Research.

**3.1.4.3.4** Surface Resistivity testing may be completed by the Bureau of Materials & Research in accordance with AASHTO TP 95 at an age of 56 days or later. The Fabricator shall obtain one additional core from the web of the girder test section and submit the cores to the Bureau of Materials & Research for permeability testing. The Fabricator shall also submit one additional match cured cylinder from the test placement to the Bureau of Materials & Research for permeability testing.

**3.1.4.3.5** Approval to proceed to member fabrication will be provided by the Bureau of Materials & Research and shall be contingent on successfully achieving the minimum design compressive strength in each of the match cured cylinders and cores tested at 28 days. If unsatisfactory results occur or conditions arise to hinder the outcome of the tests, the Engineer will require a new test section placement, with modifications as deemed necessary, to be poured and successfully tested.

**3.1.4.3.6 Test Section Exemption.** Fabricators having proven experience with the mix design submitted for use, in precast/prestressed bridge member applications, shall be exempt from the test section placement, as approved by the Department. Proven experience will be determined by the Bureau of Materials and Research based on submission of satisfactory test results using a particular mix design that meets or exceeds the following criteria in a similar fabricated bridge member or a similar 10 foot long bridge member test section:

Compressive Strength (as specified in 3.1.4.3.5)  
Surface Resistivity (as specified in 2.8.2)  
Air content (as specified in 3.1.4.3.1 or higher)  
Slump of the concrete (as specified in 2.8.2)

Approval to proceed to member fabrication will be provided by the Bureau of Materials and Research and shall be contingent on review and approval of the submitted test results.

### 3.1.5 Member Concrete Strength Testing.

**3.1.5.1** The Fabricator shall submit to the Bureau of Materials & Research results of temperature match cured cylinders (a set of two, averaged to comprise one strength test) tested for compressive strength at release and design compressive strength at 28 days (or other time interval to attain design compressive strength detailed) for each bed cast.

**3.1.5.2** Each member cast shall have a minimum of two additional match cured cylinders for each thermocouple used available for testing by the Department at 28 days (or other time interval to attain design compressive strength detailed) for quality assurance. Acceptance of the concrete within each member will be based on successfully achieving a minimum average design compressive strength for two match cured quality assurance cylinders.

### 3.1.6 Member Concrete Permeability Testing.

**3.1.6.1** Surface Resistivity testing may be completed on all member types by the Bureau of Materials & Research in accordance with AASHTO TP 95 at an age of 56 days or later. The Fabricator shall submit one match cured cylinder from each bed cast to the Bureau of Materials & Research for permeability testing.

**3.1.6.2** Acceptance of the concrete within each bed cast will be based on successfully achieving the minimum average surface resistivity value of 15 k $\Omega$ -cm at 56 days for one match cured quality assurance cylinder.

### 3.2 Qualification of the Fabricator.

**3.2.1 Minimum Requirements.** All plants/shops fabricating material for the Department shall satisfy the following minimum requirements:

**3.2.1.1 Certification.** The precast concrete manufacturing plant shall be certified by the Prestressed Concrete Institute Plant Certification Program. The Fabricator shall submit proof of certification prior to the start of production.

Certification shall be as follows:

For deck panels, certification shall be category B2 or higher.

For straight strand members, certification shall be category B3 or higher.

For draped strand members, certification shall be in category B4.

**3.2.1.2 Engineering/Drafting.** The Fabricator shall have trained, knowledgeable, and experienced drafting personnel available who can produce and check legible, complete, and accurate shop detail drawings.

**3.2.1.3 Specifications.** The Fabricator shall have available in the shop all pertinent specifications governing the work.

**3.2.1.4 Technician.** The Fabricator shall provide a technician having at least 5 years continuous experience in the manufacture of prestressed members, who shall supervise the work.

**3.2.2 Quality Control.** The Fabricator shall perform quality control functions to ensure that the product is fabricated in accordance with Contract documents and specifications.

### 3.3 Alternate Strand Patterns.

The use of alternate strand patterns are subject to the approval of the Bureau of Bridge Design. The design of debonded strand patterns are subject to the requirements listed in Appendix C of this specification.

**3.3.1 Changes to the eccentricity** of the prestressing force at any location within the member shall have the following additional requirements. Upon approval, plans with details showing the proposed changes shall be submitted for inclusion into the Plans on file in the Bridge Design office. The plans shall include the State's standard border and title box and shall be on archival quality, 22" x 34" double matte Mylar. The plans shall include member sections and strand eccentricities at appropriate locations, a member elevation showing proposed changes (draping, debonding, mild reinforcement, etc.) and other pertinent information resulting from changes in the design. The plans shall be stamped by a Licensed Professional Engineer licensed in the State of NH. The design calculations and load rating form (Form 4) shall be submitted for documentation and stamped by a Licensed Professional Engineer licensed in the State of NH.

### 3.4 Shop Drawings.

**3.4.1** The Contractor shall prepare and submit shop details, and all other necessary working drawings for approval in accordance with the requirements of [105.02](#). The Contractor shall submit six copies of the shop drawings for approval.

**3.4.2** Fabrication shall not begin until written approval of the submitted shop drawings has been received from the Engineer.

**3.4.3** Deviation from the approved shop drawings will not be permitted without written order or approval of the Engineer.

**3.4.4 Tracings.** Original tracings of all corrected shop drawings shall be delivered to the Department before final payment will be made.

### 3.5 Shop Inspection.

**3.5.1 Inspection.** A Department Representative will inspect the fabrication of the members for quality assurance. This inspection will include the examination of materials, work procedures, and the final fabricated product.

**3.5.1.1** Fabrication shall only be done in the presence of an authorized inspector representing the Department. The Department's authorized quality assurance inspector is herein referred to as the "Inspector".

**3.5.2 Notice.** At least fourteen (14) days prior to the scheduled start of casting on any member or test section, the Fabricator shall contact the Department's Bureau of Materials and Research to provide notice of the scheduled start date. The Bureau of Materials and Research will assign an Inspector to the scheduled work to provide quality assurance testing. The Inspector will coordinate directly with the Fabricator to determine the casting schedule.

**3.5.2.1** In addition to the requirements of 3.5.2, the Fabricator shall contact the Bureau of Materials and Research at least two (2) days before the actual work begins to allow scheduling of independent assurance testing by the Bureau.

**3.5.3 Authority.** The Inspector shall have the authority to reject any material or workmanship that does not meet the requirements of the Contract documents.

## SECTION 528

**3.5.3.1** Inspection at the shop is intended as a means of facilitating the work and avoiding errors. It does not constitute final approval and will not relieve the Contractor from any responsibility in regard to imperfect material or workmanship and the necessity for replacing same.

**3.5.4 Acceptance.** The Inspector shall affix an acceptance stamp to members ready for shipment. This mark shall be made by paint or ink stamp in a location that will not be visible when the structure is completed.

**3.5.4.1** The Fabricator shall present the Inspector with a copy of the shipping invoice to be stamped for verification of inspection and approval prior to shipment.

**3.5.4.2** The Inspector's acceptance implies that, in the opinion of the Inspector, the members were fabricated from accepted materials and processes and loaded for shipment in accordance with the Contract requirements. The Inspector's stamp of acceptance for shipment does not imply that the members will not be rejected by the Engineer if subsequently found to be defective.

**3.5.5 Cooperation.** The Fabricator shall fully cooperate with the Inspector in the inspection of the work in progress.

**3.5.5.1** The Fabricator shall allow the Inspector unrestricted access to the necessary areas of the shop during work hours. Work done while the Inspector has been refused access shall be automatically rejected.

### 3.6 Stressing Equipment.

**3.6.1** Prestressing shall be done with approved hydraulic jacking equipment.

**3.6.2** Hydraulic jacks shall be equipped with accurately reading pressure gauges. The combination of jack and gauge shall be calibrated and a certified graph or table showing the calibration shall be submitted to the Engineer. The calibration date shall be within a 12-month period immediately prior to the start of work.

### 3.7 Placement and Stressing of Strands.

**3.7.1** Prestressing strands shall be accurately placed to achieve the center of gravity of the strand as shown on the approved shop drawings. Strands shall be protected against corrosion and free of nicks, kinks, dirt, rust, oil, grease, and other deleterious substances.

**3.7.2** Layers of strands shall be separated by steel supports in accordance with the Concrete Reinforcing Steel Institute Manual of Standard Practice and shall be of approved shape and dimension. Suitable horizontal and vertical spacers shall be provided, if required, to keep the strands in true position in the forms. Hold-down devices used at all points of change in slope of the strands shall be of approved low-friction type.

**3.7.3** Prior to stressing, the Fabricator shall submit for approval the computations of the proposed gauge pressure, elongations of the prestressing strands (allowing for losses), and the sequence of operations. A record shall be kept of the gauge pressure and the elongation produced thereby for each strand. Complete and accurate records of each stressing operation shall be submitted to the Engineer.

**3.7.4** The mild reinforcing steel shall be placed in position after the stressing is performed unless otherwise approved.

**3.7.5** Each strand shall be stretched initially to a minimum gauge pull to eliminate all slack and equalize the stresses in the strands as determined by the Engineer before starting elongation measurements. All strands shall be in position before the stressing operation is begun.

**3.7.6** Stressing shall be performed by either simultaneous or individual application of tension to the strands. The amount of stress to be applied to each strand and the sequence of stressing shall be as shown on the plans and approved shop drawings. Stressing shall be performed only in the presence of the Inspector.

**3.7.7 Safety Measures.** Safety measures must be taken by the Fabricator to prevent accidents due to possible breaking of the prestressing strand or the slipping of the grips during the prestressing process.

**3.7.8** Several members may be cast in a continuous line and stressed at one time. Sufficient space shall be maintained between ends of members to permit access for cutting strands after the concrete has attained the required strength.

**3.8** Debonding of the prestressing strands, if required, shall be accomplished by the use of sheathing. Sheaths shall be of an approved material which is watertight, has sufficient strength to withstand concrete placement and does not react with concrete or steel. Sheaths shall be properly sealed to prevent intrusion of cement paste during concrete placement.

### 3.9 Forms.

**3.9.1** Forms shall be subject to the approval of the Engineer.

**3.9.2** Forms shall be made and maintained true to the shapes and dimensions shown on the plans.

**3.9.3** The surface of forms shall be smooth, and if necessary, joints shall be treated so that a minimum of joint marks are evident in the finished member.

**3.9.4** Forms shall be constructed and end bearing plates placed so as to allow for any shortening of the member due to compressive stresses resulting from transfer of stress and from shrinkage.

**3.9.5** Side forms shall be of steel and shall be supported without resort to ties or spreaders within the body of the member. They shall be braced and stiffened so that no deflection or curvature occurs during concrete placement.

**3.9.6** Forms shall be cleaned before each use.

### **3.10 Mixing of Concrete.**

**3.10.1** Proportioning and batching of concrete shall conform to 520.3.1 or as ordered.

### **3.11 Placement of Concrete.**

**3.11.1** Concrete shall not be deposited in the forms until the Inspector has approved the placement of the reinforcing and prestressing strands. Concrete shall be deposited only in the presence of the Inspector and in accordance with 520.3.5.

**3.11.1.1 Cold Weather.** When the average daily temperature falls below 35 °F for more than 1 day, protective measures shall be taken to prevent damage to the concrete by freezing. The protective measures shall be included on the shop drawings as required.

**3.11.2** All reinforcing and strands shall be free of dirt, rust, oil, grease, and other deleterious substances.

**3.11.3** All items encased in the concrete shall be accurately placed in the position shown on the plans and firmly held during the placing and setting of the concrete. Clearance from the forms shall be maintained by supports, spacers, or hangers in accordance with 544.3.4 and shall be of approved shape and dimension.

**3.11.4** The details of all inserts, anchors, and any other items required to be cast into the members (whether detailed on the Contract drawings or provided for the Contractor's convenience) shall be shown on the shop drawings. Members shall not be fired or drilled into for attachment purposes. All hardware shall be galvanized except as otherwise noted.

**3.11.5** The temperature of the concrete shall not exceed 90 °F when placed in the forms.

**3.11.6** Placement of concrete in stages to facilitate box beam fabrication will be allowed. Interval times between concrete placement stages shall be limited to 45 minutes to ensure that a cold joint has not formed between the two placement stages. Placement plans requiring interval times longer than 45 minutes shall be approved prior to use. Interval times extending beyond 45 minutes without prior approval are cause for rejection of the member.

### **3.12 Consolidation of Concrete.**

**3.12.1** Consolidation of concrete shall conform to 520.3.5.4 or as ordered.

**3.12.2** The vibrating shall be done with care and in such manner as to avoid displacement of reinforcing, strands, shoes, or other inserts.

**3.12.3** The size of the vibrator spud shall be proper for the size of the openings available.

**3.12.4** External vibration will be permitted.

### **3.13 Roughness of Top Surface of Member.**

**3.13.1** The top surface of all members shall be finished true by striking off at the top of the forms. A flattened area of sufficient size (4" by 4" +/-) shall be provided at the centerline of bearing and tenth points on tops of all the girders to facilitate taking elevations for measuring camber and deflection. These areas shall be steel trowel finished with a maximum difference in elevation between the high to low spots being less than 1/8".

**3.13.2** As soon as conditions permit, before the concrete has fully hardened, all dirt, laitance, and loose aggregate shall be removed from the top surface. The top surface shall be finished as shown on the plans.

**3.13.2.1** The top surface of precast prestressed deck panels shall be roughened with a broom finish.

### **3.14 Curing.**

**3.14.1 General.** The Contractor shall indicate on the shop drawings, for approval, the method of cure and a complete outline of the proposed procedure. The Contractor may choose one of the following curing methods:

## SECTION 528

- a. **Saturated Cover.** Each unit shall be immediately covered with heavy, water saturated burlap, or other material acceptable to the Inspector. The burlap shall be kept saturated, and the concrete surface temperature shall not drop below 68 °F. These conditions shall be maintained for a minimum of three days or until the concrete has reached release strength.
- b. **Low Pressure Steam.** Live steam shall be introduced into the enclosure through a series of steam jets which shall be evenly spaced within the enclosure. The initial set of the concrete shall take place before steam is introduced. The enclosure shall be at 100% relative humidity to prevent loss of moisture to ensure proper hydration of the cement. The steam curing cycle shall include a gradual heating and cooling period during which the rate of change in temperature shall not exceed 68 °F per hour. The maximum temperature inside the enclosure shall not exceed 160 °F. After the concrete has reached specified release strength, the temperature within the curing enclosure shall be decreased at an average rate not exceeding 68 °F per hour until the temperature within the curing enclosure is within 50 °F of the ambient temperature of the storage area.

**3.14.1.1** The maximum concrete temperature within the member shall be less than 160 °F.

**3.14.2 Record of Curing Time and Temperature.** The Fabricator shall provide one (1) automatic temperature recorder for every 100 ft. of member. The recorder shall continuously record curing temperatures while the member is curing. The sensors shall be carefully placed to ensure that ambient conditions are measured. Recorder accuracy shall be certified once every 12 months and the certificate displayed with each recorder. In addition, random temperature checks of each recorder shall be made by the Inspector.

Each chart shall indicate the casting bed, date of casting, time of commencing, graphic plot and the units that are represented by the chart. The start of artificial heat (if steam cured) and the transfer of prestress shall be indicated on each graphic record.

When curing is complete, the charts shall be properly marked and given to the Quality Assurance Inspector. Temperatures recorded on the charts shall be considered as verification of whether the units have been cured in accordance with the approved shop drawings.

### 3.15 Release of Prestress.

**3.15.1** A detensioning sequence shall be submitted with the shop drawings on a separate 8 1/2" x 11" sheet. The proposed sequence is for informational purposes and will be used only as a reference for the inspector during fabrication.

**3.15.2** Detensioning shall not commence until the concrete has attained a compressive strength of at least 4000 psi (or the release strength indicated on the plans) as shown by match cured test cylinders. Detensioning shall be done at approximately equal concrete strengths for all members. The temperature of match cured cylinders used for determination of adequate release strength shall be controlled by a thermocouple located in the last member cast in each bed.

**3.15.3** Detensioning shall be accomplished by a gradual release of jack pressure, or by cutting individual strands in an approved sequence. If detensioning is accomplished by single strand release, each strand shall be cut by gradually heating the strand at both ends of the member simultaneously. A minimum length of 5" of strand shall be heated to prevent any shock or snap when the strand is finally severed. Each strand shall be cut at all spaces between members when cast continuously before starting detensioning on the following strand in the sequence. All detensioning shall be performed in the presence of the Inspector.

**3.15.4** If the concrete has been heat-cured, detensioning shall be performed immediately following the curing period while the concrete is still warm and moist.

**3.15.5** Detensioning shall be kept symmetrical about the axes of the member and in the sequence submitted as part of the shop drawings.

**3.15.6** Forms, or any device which restricts either horizontal or vertical movement of the member, shall be stripped or loosened prior to detensioning.

### 3.16 Stripping Forms and Finish of Member.

**3.16.1** No forms shall be removed without approval. Proper care and precautions shall be exercised in removing forms so that no damage results to finished surfaces.

**3.16.2** The member shall receive a Class 1, Ordinary Finish in accordance with 520.3.12 except patching shall be in accordance with 3.18.

**3.16.3** The shear key joints at the sides of butted beams shall be abrasive blast-cleaned prior to shipping.

**3.16.4 Finish of Strands.** At the ends of simple span members and the free ends of members made continuous, all strands shall be recessed. Each recess shall be 1 1/2" square and 3/4" deep. Projecting strands shall be burned out unless specified otherwise on the plans and the recess cleaned prior to patching with an approved material. The entire end cross-section shall then be coated with an approved bitumastic material.

**3.16.5 Finish of Strands for Deck Panels.** At the ends of deck panels strands shall have a minimum extension of 4” beyond each end of the panel.

**3.17 Damage/Cracking.** The PCI New England Region Bridge Member Repair Guidelines, Report Number PCINER-01-BMRG shall be used in conjunction with this specification to help identify damage, determine the potential cause and appropriate repair procedure if warranted.

**3.17.1 Precast Concrete Deck Panels.** Detensioning procedures causing member cracking shall be revised before detensioning the next bed. A revised detensioning sequence shall be submitted for review as in 3.15.1.

**3.17.1.1 Rejection.** Any of the following conditions will be cause for rejection of prestressed deck panels:

1. Any crack transverse or diagonal to the strand pattern and crossing more than one strand
2. Any crack parallel to a strand and longer than 1/3 of the panel length
3. Cracks shorter than 1/3 of the panel length and present at more than 12% of the total number of strands in the panel
4. Voids or honeycombed areas with exposed strands

Deck Panels with cracks or with damage less severe than the conditions stated above shall be repaired by the Contractor using an approved procedure, at no cost to the Department.

**3.17.2 Other Members.** Detensioning procedures causing web splitting or other member cracking shall be revised before detensioning the next bed. A revised detensioning sequence shall be submitted as in 3.15.1. Cracks less than 0.01” in width shall be sealed by an approved method. Cracks in excess of 0.01” may be cause for rejection. Cracked members shall be repaired or replaced by the Contractor at the Department's direction at no cost to the Department.

### 3.18 Patching.

**3.18.1** Patching of any surface irregularities, especially those resulting from honey-combing, shall be done only after inspection for determination as to whether or not the work is acceptable.

**3.18.2** When patching is allowed, it shall be done within 24 hours after stripping, and the patching shall be damp-cured for not less than a 3-day period and kept from freezing for the following 3 days.

**3.18.3** Patching of damaged members in lieu of required replacement will not be permitted.

### 3.19 Dimensional Tolerances.

**3.19.1** All tolerances not specified otherwise, shall be in accordance with PCI MNL -116 “Manual for Quality Control for Plants and Production of Precast and Prestressed Concrete Products” except as modified herein.

**3.19.2** Camber shall be measured at consistent times within 24 hours after transfer of prestress.

**3.19.3 Dimensional Tolerances of Deck Panels.** Panels shall be manufactured in conformity with the following tolerances:

<b>Depth of panel</b>	-1/8, +1/4”
Width of panel	+/-1/4”
Length of panel	+/-1/4”
Squareness (Difference between lengths measured along diagonals)	1/2” (max.)
Vertical position of strand group (Measured from bottom of panel)	+0, -1/8”
Vertical position of individual strands	+/- 1/8”
Horizontal strand position	+/-1/4”
Strand projection	+/- 1/2”
Bowing	+/-1/8”
Dunnage	+/- 6”
Warping	1/16” per foot of distance from nearest adjacent corner

## SECTION 528

### 3.20 Handling and Storing.

**3.20.1** Members damaged during handling and storage will be repaired or replaced at the Department's direction at no cost to the Department.

**3.20.2** Members shall be lifted at the designated points by approved lifting devices embedded in the concrete and proper hoisting procedures.

**3.20.3** The points of support and the direction of the reactions with respect to the member during handling and storage shall be approximately the same as when the member is in its final position. Members shall be stored plumb.

**3.20.4** Storage areas shall be smooth and well compacted to prevent damage due to differential settlement. Stacks of members may be supported on the ground by means of continuous blocking located perpendicular to the strands at the ends. Intermediate blocking between members shall be located directly over the blocking below.

**3.20.4.1** Members shall be protected from freezing temperatures 32 °F, for 5 days or until attaining design compressive strength detailed on the plans, whichever comes first.

**3.20.5** Members may be loaded on a trailer as described above. Shock-absorbing cushioning material shall be used at all bearing points during transportation of the members. Tie-down straps shall be located at the lines of blocking only.

**3.20.6** The members shall not be subject to damaging torsional or impact stresses.

**3.20.7** Panels stored prior to shipment shall be inspected by the Contractor prior to being delivered to the site to identify damage that would be cause for repair or rejection. The Contractor shall ensure that sufficient acceptable panels are available for anticipated placement so that unacceptable delays to the project completion can be avoided.

### 3.21 Shipping.

**3.12.1** A member shall not be transported from the casting yard until the minimum 28 day compressive strength stated in 3.1.5 has been attained as shown by test cylinders cured according to 3.1.4.2, and a minimum of 7 days has elapsed from casting of the member.

### 3.22 Erection of Prestressed Concrete Members.

**3.22.1 Delivery and Field Inspection.** Material, workmanship and condition after shipment will be inspected after delivery to the construction site, with this and any previous inspections constituting only partial acceptance.

**3.22.1.1** All work of handling, assembling and erecting the members shall be subject to the inspection and approval of the Engineer, who shall be furnished with necessary facilities, including scaffolding and supports, to provide access to the structure to allow for inspection of workmanship.

**3.22.2 Erection Plans.** Before starting the work of erecting the members the Contractor shall submit an erection plan for documentation in accordance with 105.02. The erection plan shall describe the method of erection proposed and the amount and character of equipment proposed.

**3.22.3 Temporary Bracing for Girders.** After a girder has been erected, temporary braces shall be provided as necessary to resist wind and other loads. Details of temporary bracing shall be provided as part of the erection plans.

**3.22.4 Bearings.** Bearings shall be installed in accordance with Section 548.

**3.22.5 Sequence of Construction for Butted Beams.** The installation of the butted beams shall be in accordance with 528 Appendix A or B as appropriate.

#### 3.22.6 Installation of Deck Panels.

**3.22.6.1** Panels shall be installed as shown on the plans. The temporary supports shall be attached to the top flange of the girder with an approved adhesive in accordance with the Manufacturer's recommendations. The temporary supports shall be cut in the field to the required height after the blocking depth has been determined.

**3.22.6.2** Multiple panels shall not be stacked on a panel after it has been placed on the temporary supports without the approval of the Engineer.

**3.22.6.3** Panels shall not be used to support heavy loads until the top slab is cast and cured. Construction loads on individual panels shall be uniformly applied and shall not exceed an average loading of approximately 40 pounds per square ft.

**3.22.6.4** After the panels have been placed on the temporary supports, the area under the ends of the panels and over the girder flanges up to the bottom of the panels shall be completely filled with Concrete Class AA, Including High Range Water Reducing Admixture as shown on the plans. The concrete shall cure a minimum of three (3) days prior to placing the concrete deck. If leveling screws are used, they shall be completely removed and the holes filled with grout prior to the placement of deck concrete.



**3.22.6.5** Prior to placement of the deck concrete, laitance or other contaminants that would interfere with full bond to the panels shall be removed by an approved method.

#### Method of Measurement

**4.1** Prestressed concrete girders will not be measured, but shall be the linear foot final pay quantities in accordance with 109.11 for material required with the limits shown on the plans.

**4.2** Prestressed concrete bridge deck will not be measured, but shall be the square foot final pay quantities in accordance with 109.11 for material required with the limits shown on the plans.

**4.3** Prestressed concrete deck panels will not be measured, but shall be the square foot final pay quantities in accordance with 109.11 for material required with the limits shown on the plans.

#### Basis of Payment

**5.1** Prestressed concrete girders are a final pay quantity item and will be paid for at the Contract unit price per linear foot complete in place in accordance with 109.11.

**5.1.1** Test sections (if required) will be paid as provided for in 109.04.

**5.2** Prestressed concrete bridge deck members are a final pay quantity item and will be paid for at the Contract unit price per square foot complete in place in accordance with 109.11.

**5.3** Prestressed concrete deck panels are a final pay quantity item and will be paid for at the Contract unit price per square foot complete in place in accordance with 109.11.

#### Pay items and unit:

528.1110	Prestressed Concrete Girders, NEBT 1000 (F)	Linear Foot
528.1112	Prestressed Concrete Girders, NEBT 1200 (F)	Linear Foot
528.1114	Prestressed Concrete Girders, NEBT 1400 (F)	Linear Foot
528.1116	Prestressed Concrete Girders, NEBT 1600 (F)	Linear Foot
528.1118	Prestressed Concrete Girders, NEBT 1800 (F)	Linear Foot
528.12__	Prestressed Concrete Girders, Spread Box Beams (F)	Linear Foot
528.31__	Prestressed Concrete Bridge Deck, Butted Deck Beams (F)	Square Foot
528.32__	Prestressed Concrete Bridge Deck, Butted Box Beams (F)	Square Foot
528.5__	Prestressed Concrete Deck Panels (F)	Square Foot

## APPENDIX A

**SEQUENCE OF CONSTRUCTION FOR  
BUTTED BOX AND BUTTED DECK BEAM SUPERSTRUCTURES  
(SKEWS  $\leq 30^\circ$ )****A) Layout Working Lines**

- Working lines shall be laid out on the beam seat for the entire width of the bridge. All working lines are to be measured from a common working point.
- The working lines are to be based on the nominal beam widths.

**B) Verify Beam Seat Elevations**

- Take elevations at beam seats
- If seats are high, grind to correct elevations.
- If seats are low, shim as required. Shims to be high durometer neoprene or high density plastic.
- Install bearing pads.

**C) Erect Beams**

- Pressure wash sides of beams.
- Beams shall be placed to fit within the working lines.
- As work progresses, install hardwood wedges between adjacent beams to maintain proper shear key joint opening. Install a minimum of one wedge at each transverse tie location.

**D) Install Polyethylene Closed Cell Backer Rod as Joint Filler at Shear Key Locations.**

- Filler shall be placed below the bottom of the shear key joints as shown on the Plans and shall conform to key depth change in configuration at the transverse tie locations. Filler shall be installed sufficiently tight to prevent loss of the shear key grout.

**E) Install Transverse Ties**

- Feed transverse ties through ducts.
- Verify that hardwood wedges are in place as required to prevent slippage of beams.
- Using a calibrated jack, post-tension transverse ties to approximately 5,000 lbs. to remove sag in the tie and to seat the chuck.
- For stage construction, the second stage transverse tie ducts shall be protected at the shear key joints by installing second stage transverse ties or placing Extruded Polystyrene Rigid Foam (XPS) over the duct opening.

**F) Grout Shear Key**

A correctly grouted shear key joint is necessary to ensure the structural integrity of the superstructure.

- Clean the shear key joint with an oil free air-blast immediately prior to grout placement. Verify that the backer rod is still in place.
- Additional shear key joint preparation and grout placement shall be per the Manufacturer's recommendations.
- Shear key joints shall be carefully rodded to eliminate voids.

**G) Post-Tension Transverse Ties**

- Shear key grout shall attain a minimum compressive strength of 1500 psi, based on the Manufacturer's recommendations, prior to stressing.
- Using a calibrated jack operated by qualified personnel, post-tension transverse ties to 30,000 lbs. beginning with inner most ties and proceeding symmetrically about mid-span towards the member ends. Inner ties shall be re-checked to ensure that the ties have 30,000 lbs. of tension. (For box beams with top and bottom transverse ties: tension the bottom tie to 15,000 lbs. then tension the top tie to 15,000 lbs. Repeat the sequence once more so that each transverse tie has 30,000 lbs. of tension.)

**H) Finish Work**

- Remove wedges and patch the deck and fascia beams at transverse tie locations.
- Place abutment concrete above the beam seat construction joint.
- Place brush curb and overlay concrete.

**APPENDIX B**  
**SEQUENCE OF CONSTRUCTION**  
**FOR**  
**BUTTED BOX AND BUTTED DECK BEAM SUPERSTRUCTURES**  
**(STITCHED CONSTRUCTION SKEWS > 30°)**

**A) Layout Working Lines**

- Working lines shall be laid out on the beam seat for the entire width of the bridge. All working lines are to be measured from a common working point.
- The working lines are to be based on the nominal beam widths.

**B) Verify Beam Seat Elevations**

- Take elevations at beam seats
- If seats are high, grind to correct elevations.
- If seats are low, shim as required. Shims to be high durometer neoprene or high density plastic.
- Install bearing pads.

**C) Erect Beams**

- Pressure wash sides of beams.
- Beams shall be placed to fit within the working lines.
- Each beam is erected with a preset dead-end chuck and transverse tie in place. As each beam is erected, the live end of the transverse tie from the preceding beam is worked through the duct.
- Install hardwood wedges between adjacent beams to maintain proper shear key joint opening. Install a minimum of two wedges at each transverse tie location, one on top and the other under the beam.
- Using a calibrated jack operated by qualified personnel, post-tension transverse ties to 30,000 lbs. (For box beams with top and bottom transverse ties: tension the bottom tie to 15,000 lbs. then tension the top tie to 15,000 lbs. Repeat the sequence once more so that each transverse tie has 30,000 lbs. of tension)
- Repeat above steps until all beams are erected.

**D) Install Polyethylene Closed Cell Backer Rod as Joint Filler at Shear Key Locations.**

- Filler shall be placed below the bottom of the shear key joints as shown on the Plans. Care shall be used to seal the joint under the transverse tie and maintain the proper shape of the key at all transverse tie locations. Filler shall be installed sufficiently tight to prevent the loss of the shear key grout.

**E) Grout Shear Key**

A correctly grouted shear key joint is necessary to ensure the structural integrity of the superstructure.

- Clean the shear key joint with an oil free air-blast immediately prior to grout placement. Verify that the backer rod is still in place.
- Additional shear key joint preparation and grout placement shall be per the Manufacturer's recommendations.
- Shear key joints shall be carefully rodded to eliminate voids.

**F) Finish Work**

- Remove wedges, and patch the deck and fascia beams at transverse tie locations.
- Place abutment concrete above the beam seat construction joint.
- Place brush curb and overlay concrete.

**APPENDIX C  
DESIGN REQUIREMENTS  
FOR  
PARTIALLY DEBONDED STRANDS**

The use of partially debonded strands shall be subject to the following requirements:

1. The number of debonded strands shall not exceed 25% of the total number of strands.
2. The number of debonded strands in any horizontal row shall not exceed 40% of the strands in that row.
3. Center to center spacing between debonded strands in a horizontal row shall be 4" or greater.
4. Exterior strands in each horizontal row shall be fully bonded.
5. Debonded strands shall be placed in pairs, symmetrically distributed about the centerline of the member, within the same row. The debonded length of a pair of strands shall be equal.
6. Debonded lengths of strand shall be staggered. No two pairs shall have the same debonded length and debonded lengths shall differ by at least 1 foot.
7. Debonded lengths at each end of the member shall be limited to 15% of the member length.

**APPENDIX D**  
**ALTERNATE METHOD FOR THE CALCULATION**  
**OF THE REQUIRED AVERAGE COMPRESSIVE STRENGTH**  
**FOR THE MIX DESIGN**

**1) Standard Deviation**

- 1.1) A standard deviation shall be established from test records of the mix design. Test records from which a standard deviation is calculated:
- a. Shall represent materials, quality control procedures, and conditions similar to those expected and changes in materials and proportions within the test records shall not have been more restricted than those for proposed work.
  - b. Shall represent concrete produced to meet a specified strength or strengths  $f'c$  within 1000 psi of that specified for proposed work.
  - c. Shall consist of at least 30 consecutive tests or two groups of consecutive tests totaling at least 30 tests except as provided in (1.2). A strength test shall be the average of the strength of two cylinders made from the same sample of concrete and tested at 28 days.
- 1.2) Where a concrete production facility does not have test records meeting requirements of (1.1), but does have a record based on 15 to 29 consecutive tests, a standard deviation shall be established as the product of the calculated standard deviation and modification factor of Table 528-1. To be acceptable, test records shall meet requirements (a) and (b) of (1.1), and represent only a single record of consecutive tests that span a period of not less than 45 calendar days.

1.3) Calculation of Standard Deviation

When a concrete production facility has a suitable record of 30 consecutive tests of similar materials and conditions expected, the standard deviation is calculated from those results in accordance with the following formula:

EQ1

$$s = \left( \frac{\sum (X_i - \bar{X})^2}{(n - 1)} \right)^{1/2}$$

where:

$s$  = standard deviation, psi

$X_i$  = individual strength tests

$\bar{X}$  = average of  $n$  strength test results

$n$  = number of consecutive strength tests

The standard deviation is used to determine the average strength required in (2.1).

## SECTION 528

If two test records are used to obtain at least 30 tests, the standard deviation used shall be the statistical average of the values calculated from each test record in accordance with the following formula:

$$\text{EQ. 2} \quad \bar{s} = \left[ \frac{n_1 - 1)(s_1)^2 + (n_2 - 1)(s_2)^2}{(n_1 + n_2 - 2)} \right]^{1/2}$$

where

$\bar{s}$  = statistical average standard deviation where two test records are used to estimate the standard deviation

$s_1, s_2$  = standard deviations calculated from two test records, 1 and 2, respectively

$n_1, n_2$  = number of tests in each test record, respectively

If less than 30, but at least 15 tests are available, the calculated standard deviation is increased by the factor given in Table 528-1.

**TABLE 528-1 - MODIFICATION FACTOR FOR STANDARD DEVIATION WHEN LESS THAN 30 TESTS ARE AVAILABLE**

No. of tests*	Modification factor for standard deviation†
less than 15	Use Table 528-2
15	1.16
20	1.08
25	1.03
30 or more	1.00

\* Interpolate for intermediate numbers of tests.

† Modified standard deviation to be used to determine required average strength  $f'_{cr}$  from (2.1).

### 2) Required average strength

2.1) Required average compressive strength  $f'_{cr}$  used as the basis for selection of concrete proportions shall be the larger of EQ. (3) or EQ (4) using a standard deviation calculated in accordance with (1).

$$\text{EQ. 3} \quad f'_{cr} = f'_c + 1.34s$$

or

$$\text{EQ. 4} \quad f'_{cr} = f'_c + 2.33s - 500$$

$s$  shall be computed accordingly to 1.3.

$f'_c$  = specified compressive strength of concrete, psi

$f'_{cr}$  = required average compressive strength of concrete for mix design, psi

- 2.2) When a concrete production facility does not have field strength test records for calculation of standard deviation meeting requirements of (1), required average strength  $f'_{cr}$  shall be determined from Table 528-2 and documentation of average strength shall be in accordance with requirements of (3).

**TABLE 528-2 - REQUIRED AVERAGE COMPRESSIVE STRENGTH WHEN DATA ARE NOT AVAILABLE TO ESTABLISH A STANDARD DEVIATION**

Specified compressive strength $f'_c$ psi	Required average compressive strength $f'_{cr}$ psi
Less than 3000 psi	$f'_c + 1000$
3000 to 5000	$f'_c + 1200$
Over 5000	$f'_c + 1400$

**3) Documentation of average strength**

Documentation that proposed concrete proportions will produce an average compressive strength equal to or greater than required average compressive strength calculated in accordance with (2), shall consist of a field strength test records, several strength test records, or trial mixtures.

## SECTION 530

### ***SECTION 530 -- WATERPROOFING CONCRETE SURFACES***

#### **Description**

1.1 This work shall consist of waterproofing concrete surfaces shown on the plans or ordered with two coats of a cement base waterproof coating for concrete.

#### **Materials**

- 2.1 All components of this system shall be compatible and shall be furnished by the same supplier.
- 2.2 All materials shall be delivered to the job site in sealed containers bearing the manufacturer's original labels.
- 2.3 The color when dry shall be a shade of gray matching the concrete.
- 2.4 Materials used for this specification shall be a product as included on the [Qualified Products List](#).
- 2.5 The mixture shall not contain calcium chloride or sodium chloride.

#### **Construction Requirements**

##### **3.1 Preparation of Surfaces.**

3.1.1 The concrete face to be coated shall be cleaned of all laitance, dirt, dust, oil, efflorescence, paint, and other foreign material by the use of sandblasting or waterblasting. Suitable traps shall be installed in sandblasting or waterblasting equipment to prevent oil from being deposited on the surface.

3.1.2 Surfaces which have been cured by the use of curing compound shall not be coated with waterproof finish until at least 30 days have elapsed since curing compound application.

##### **3.2 Brush and Flat Waterproofed Finish.**

3.2.1 All work shall be performed by an experienced Contractor who is familiar with waterproofing work and with the materials specified herein.

3.2.2 No application is to be made when atmospheric temperature is 45 °F or below, or if it is expected to drop below 45 °F within 24 hours after application. Do not apply to frozen or frost-filled surfaces. If the application is made during hot weather, cool the surface with clean water first.

3.2.3 All materials shall be mixed according to the manufacturer's printed instructions and a copy of such instructions shall be maintained on the project.

3.2.4 The cement base waterproof coatings shall be applied by the use of a masonry brush to a slightly dampened surface. The material shall be cured in accordance with the manufacturer's recommendations. Sufficient material must be applied to fill and seal all pores and voids to achieve a uniform appearance.

3.2.5 The cement base, acrylic latex, coating shall be applied at the rate recommended by the manufacturer.

3.2.6 The cement base, polymer-modified, coating shall be applied at the rate recommended by the manufacturer.

3.2.7 Whenever construction or contraction joints appear in the existing or new concrete to be coated, the joints shall be tooled to allow bond breakage of the coating at the joint.

#### **Method of Measurement**

4.1 Waterproofing concrete surfaces will not be measured, but shall be the square yard final pay quantity in accordance with [109.11](#) of coated surface within the limits shown on the plans.

#### **Basis of Payment**

5.1 Waterproofing concrete surfaces is a final pay quantity item and will be paid for at the Contract unit price per square yard complete in place in accordance with [109.11](#).

#### **Pay item and unit:**

530.3	Waterproofing Concrete Surfaces (F)	Square Yard
-------	-------------------------------------	-------------



**SECTION 534 -- WATER REPELLENT****Description**

**1.1** Water repellent shall be applied to the concrete surfaces shown on the plan or as ordered. Surfaces to be treated shall normally consist of the following portions of all bridges: concrete curbs, sidewalks (top, fascia, bottoms), wingwalls, piers, and abutment face walls and bridge seats when not coated with epoxy coating.

**Materials**

**2.1** Water repellent (Silane/Siloxane) shall be a product as included on the [Qualified Products List](#).

**Construction Requirements**

**3.1 General.** All caulking, patch, and joint sealers shall be installed prior to application of the water repellent. Concrete surfaces shall have cured a minimum of 14 days and shall be dry prior to the application of water repellent. Minimum substrate and ambient application temperatures shall be as noted on the [Qualified Products List](#) for the product used except as allowed in 3.1.2 and 3.1.3. Do not apply when substrate surface temperature exceeds 85°.

**3.1.1** All surfaces specified for treatment, that require finishing, shall be protected from freezing and de-icing chemicals until coated with water repellent. All finished surfaces specified for treatment must be treated before winter shutdown.

**3.1.2** If the project schedule requires that surfaces be coated outside the product application temperatures listed in the [Qualified Products List](#), those surfaces shall be recoated during the next construction season with the same product when the application temperature is within the listed temperature range and other conditions meet manufacturer's recommendations during the next construction season. Prior to reapplication of water repellent, the surface shall be thoroughly cleaned by water blasting and allowed to dry.

**3.1.3** If cold weather concreting practices as described in [520.3.7](#) are being followed, the 14-day provision of 3.1 is waived. The concrete shall be coated as soon as it is dry after the five-day period specified in [520.3.7](#) and it shall be protected from freezing until coated. Concrete that is treated with water repellent under these conditions shall be recoated as described in 3.1.2.

**3.2** Water repellent (silane/siloxane) shall be applied at the heaviest coverage recommended by the manufacturer. Ambient application temperatures, except as allowed in sections 3.1.2 and 3.1.3, shall conform to the product application temperature listed on the [Qualified Products List](#).

**3.2.1** A test application shall be performed on the surface to be treated, to ensure compatibility, using the same equipment to be used on the project. After a minimum of three days, the Engineer shall test for waterproof effectiveness by applying water to the surface. If the water beads up and is not readily absorbed, the test is positive.

**3.2.2** The Contractor shall follow the manufacturer's instructions in the method of preparation of the concrete and application of the sealer.

**3.2.3** The Contractor shall protect the concrete surface from rust staining. Any staining that does occur shall be removed by mopping with a solution containing 1lb. of oxalic acid powder per gallon of water. After 2 or 3 hours, rinse the surface with clear water, scrubbing at the same time with a stiff brush. Tough stains may require a second treatment. If rust stains still persist, other means of removal may be allowed by the Engineer. Areas that had been coated with water repellent prior to removal of rust stains shall be recoated at the application rate specified in 3.2.

**Method of measurement**

**4.1** Water repellent (Silane/Siloxane), applied to surfaces within the limits shown in the plans or specified herein and at the rate required will be measured by the gallon.

**4.2** Water repellent used to recoat areas where rust stains were removed will not be measured for payment.

**4.3** The Engineer's estimated quantity of Water Repellent (Silane/Siloxane) is based on an application rate of 150 sf/gal.

**Basis of Payment**

**5.1** Water repellent will be paid for at the Contract unit price per gallon, complete in place. The reapplication of water repellent as required in 3.1.2 and 3.1.3 will be done at the Contractor's expense unless the required reapplication was due to circumstances beyond the Contractor's control, as determined by the Engineer.

**5.2** Removal of rust stains and recoating with water repellent will be at the Contractor's expense.

**5.3** The pay quantity of Water Repellent (Silane/Siloxane) shall be the actual amount used as per 534.3.2.

**Pay items and units:**

534.3	Water Repellent (Silane/Siloxane)	Gallon
-------	-----------------------------------	--------

**SECTION 536 -- EPOXY COATING FOR CONCRETE****Description**

**1.1** This work shall consist of furnishing and placing on concrete surfaces as shown on the plans a flexible, minimum two-coat, epoxy coating system consisting of a mortar coat and one or more seal coats. The resulting color shall be approximately the shade of hardened concrete.

**Materials**

**2.1** Epoxy coating shall be an epoxy compound and shall be furnished in two components for combining immediately prior to use in accordance with the stipulations in this specification. The epoxy coating system shall be a product approved by the Engineer.

**2.1.1** The material for the mortar coat shall consist of 100 percent solids. The Component "A" shall be an epoxy resin containing a thixotropic agent. The Component "B" (Hardener) shall be chemically pure amido-amine or poly-amide with no other fillers, diluents or wettings, or volatile solvents. Sand shall be used in the mortar coat. The proportion of sand in the epoxy mortar shall be as recommended by the manufacturer. The two components of the epoxy system furnished under this specification shall be supplied in separate pre-proportioned containers. A unit of Component "A" shall be supplied in a container with enough capacity to allow the mixing in it of the Component "B", together with the sand for the mortar coat.

**2.1.2** The material for the seal coat shall consist of a pigmented, solvent-cut two-component epoxy polyamide. The color shall be concrete gray.

**2.1.3** Containers shall be identified as "Component A, Contains Epoxy Resin" and "Component B, Contains Hardener". Labels shall show the component type, whether trowel grade or brush grade, mixing directions, and usable temperature range, all as defined by this specification. Each container shall be marked with the name of the manufacturer, the lot or batch number, the date of packaging, pigmentation, if any, and the quantity contained therein in pounds and gallons.

**2.1.4** At 70 °F, the mortar grade shall have a pot life of at least 45 minutes and the brush grade shall have a pot life of at least 8 hours.

**2.1.5** The epoxy shall be formulated for application at a temperature of 40 °F and above.

**2.1.6 Storage.** The Components A and B should be stored in a cool place in warm weather and a warm place in cold weather.

**2.2** Sand for mortar coat shall be Ottawa silica sand, or an approved equivalent, which will closely approximate the color of concrete. The sand shall be so graded that 100 percent by weight will pass a No. 4 sieve, 20 to 30 percent will pass a No. 50 sieve and 0 to 5 percent will pass a No. 100 sieve.

**2.2.1** Sand shall be furnished on the project as a pre-dried product in moisture-proof containers.

**Construction Requirements**

**3.1 Preparation and surfaces.** Acid etching will not be allowed. Surfaces of concrete shall not be "finished" but shall be sandblast cleaned before applying the first coat, not only to remove all film or laitance, but also to remove the surface of the concrete deep enough to eliminate any formation over voids. The object is to obtain a durable concrete surface. The area to be treated must be surface-dry, and all dust and sand residue from blast cleaning shall be removed. The temperature of the concrete shall be 40 °F or above. Concrete shall be cured a minimum of 14 days, before coating is applied.

**3.2 Mixing.** Mixing of the epoxy shall be done immediately prior to use and strictly in accordance with the manufacturer's directions shown on the container. The epoxy resin and hardener shall be mixed the specified time using an approved propeller-type stirrer designed for the quantity to be mixed. For the mortar coat, after the 2 components have been thoroughly mixed, sand shall be added strictly in the proportion ordered, and mixing shall be continued until a homogeneous mixture has been obtained.

**3.3 Applications.**

**3.3.1 Mortar coat.** The epoxy and sand mixture shall be applied with a screed or trowel to completely fill all cavities or imperfections present in the concrete. Depending upon the particular brand used and the quality of the concrete surface, to cover 30 ft<sup>2</sup> of area with the trowel coat may require approximately 1 gal of the mixture.

**3.3.2 Seal coat.** After the mortar coat has hardened, the seal coat shall be applied as soon as possible using a brush or roller in the manner recommended by the manufacturer and taking extreme care to fill all pinholes or other voids which may exist in the underlying coat. It is estimated that to cover approximately 200 ft<sup>2</sup> of surface will require 1 gal of epoxy seal coat.

**3.3.3** In case adequate coverage has not been obtained, one or more additional coats may be ordered.

**3.4 Safety precautions.** Proper protective equipment shall be used and other actions shall be taken against the possibility of skin damage to humans and against the possibility of fire, since the material may be a dermatitis producer and a fire hazard.

**Method or Measurement**

4.1 Epoxy coating of the type specified will not be measured, but shall be the square foot final pay quantity in accordance with 109.11 for the coated surface required within the limits shown on the plans.

**Basis of Payment**

5.1 Epoxy coating of the type specified is a final pay quantity item and will be paid for at the Contract unit price per square foot complete in place in accordance with 109.11.

**Pay items and units:**

536.11	Epoxy Coating for Concrete (F)	Square Foot
--------	--------------------------------	-------------

**SECTION 538 -- BARRIER MEMBRANE****Description**

**1.1** This work shall consist of furnishing and applying an approved waterproof membrane system as shown on the plans or as ordered.

**1.2** When “Barrier Membrane, Heat Welded” or “Barrier Membrane, Heat Welded – Machine Method” is specified, the Contractor shall arrange for a manufacturer’s representative (Representative) to be present at all times work is performed, including application of the primer and tack coat. The Representative shall also be present for placement of the hot bituminous pavement overlay. The Representative shall be readily identified by a photo ID badge, issued by the manufacturer, that includes the manufacturer’s name and logo, a current photograph of the Representative, the Representative’s full name, and the word “Representative”. The text of the badge shall be clearly printed in English. The Representative shall have the badge on his/her person and available for inspection at all times work is performed under this specification.

**1.2.1** In performing work under this specification, the Contractor shall anticipate and provide for quality assurance testing and inspection by the Engineer or his/her authorized representatives.

**1.2.2** When “Barrier Membrane, Heat Welded – Machine Method” is specified, the machine shall meet the requirements of 538.3.3.3.1.

**Materials****2.1 Barrier membrane, Peel and Stick.**

**2.1.1** “Barrier membrane, Peel and Stick” and “Barrier membrane, Peel and Stick – Vertical Surfaces” shall consist of adhesive primer, preformed waterproofing membrane sheet and mastic all as one system as included on the [Qualified Products List](#).

**2.2** Protection board shall be a product as included on the [Qualified Products List](#).

**2.3 Barrier Membrane, Heat Welded.**

**2.3.1** “Barrier Membrane, Heat Welded” shall consist of an approved prefabricated reinforcement of synthetic non-woven material, thoroughly impregnated and coated with SBS modified bitumen as included on the [Qualified Products List](#). When machine method is specified, the membrane system shall be listed as such on the [Qualified Products List](#).

**2.3.2** The system shall include a primer that enhances the adhesive bond between the concrete deck and the membrane, and a tack coat that enhances the bond between the membrane and the hot bituminous pavement overlay, all as included on the [Qualified Products List](#).

**2.3.2.1** When approved in writing by the membrane manufacturer, a tack coat meeting the requirements of 410.2.1 may be used in lieu of the tack coat that is listed on the [Qualified Products List](#).

**2.3.3** Hot-applied rubberized asphalt for sealing the curb line shall be a product as included on the [Qualified Products List](#).

**Construction Requirements****3.1 General.**

**3.1.1** Concrete shall be cured in accordance with the requirements of 520.3.10. The primer and membrane shall only be applied when the substrate surface has a moisture content of 6 percent or less, and when the temperature of the substrate exceeds the dew point by at least 5° F. The Contractor shall supply a portable electronic surface moisture meter capable of measuring the moisture content of concrete surfaces in percent. The moisture meter shall be a product that is listed on the [Qualified Products List](#) and shall be calibrated annually by the meter manufacturer. A certificate of calibration from the meter manufacturer shall accompany the moisture meter. The Contractor shall also supply a digital weather instrument that can measure both ambient temperature and dew point, and an infrared surface temperature measuring instrument.

**3.1.2** The air temperature and the substrate temperature shall be at least 40 °F and rising.

**3.2 Barrier Membrane – Peel and Stick.**

**3.2.1 Preparation of the surface.** The concrete surface shall have a uniform, fine-textured finish that is free of protrusions. All honeycombed areas and surface cavities shall be cleaned and filled with approved patching materials. The surface to be membraned shall be clean and free of laitance, oil and foreign materials.

**3.2.2 Application of adhesive primer.** Immediately prior to application of the primer, the surface shall be cleaned by brooms and compressed air. The concrete surface shall be inspected and approved by the Engineer prior to priming.

**3.2.2.1** The adhesive primer shall be thoroughly mixed before use and applied by roller only and allowed to cure in accordance with the manufacturer’s recommendations.

**3.2.3 Application of membrane.** Membrane shall be installed in a shingled pattern so that water is permitted to drain without accumulating against seams. The membrane shall be pressed or rolled into place to assure bond with the primed surface and elimination of air bubbles. Lap joints at the beginning and end of rolls shall be staggered with those of adjacent rolls and shall be sealed in accordance with the manufacturer's recommendation.

**3.2.3.1** All expansion joints, areas around drains, all membrane junctions with curbs, end dams, protrusions, and all inside corners shall receive an extra 6" wide strip of preformed membrane prior to normal coverage.

**3.2.3.2** Torn or damaged membrane shall be repaired in accordance with manufacturer's recommendations.

**3.2.3.3** Membraned surfaces to be backfilled against, including horizontal surfaces of box culverts and rigid frames, shall be protected from rupture by a protection board as listed on the [Qualified Products List](#).

### **3.3 Barrier Membrane – Heat Welded.**

**3.3.1 Preparation of the surface.** The surface of the deck shall have a uniform fine-textured finish. In lieu of patching, surface cavities shall be ground to form a smooth transition across the deck surface as directed by the Engineer.

**3.3.1.1** The entire deck shall be shot-blasted using self-contained, self-propelled equipment to achieve a consistent anchor profile that is free of sharp protrusions. Abrasive media shall consist of a blend of shot and grit sufficient to provide an angular surface profile that meets the requirements of 3.3.1.1.2. Areas that are not accessible to self-propelled shot blasting equipment, as determined by the Engineer, shall be blasted with appropriate equipment utilizing either mineral grit or steel grit and air pressure sufficient to achieve the specified surface profile.

**3.3.1.1.1** Suitable traps shall be installed in shot-blasting equipment to prevent foreign substances from being deposited on the surface.

**3.3.1.1.2** The Contractor shall provide a copy of Technical Guideline No. 03732, published by the International Concrete Repair Institute including the benchmark profile coupons. The final concrete surface profile shall be between CSP 3 and CSP 5 as defined by this Guideline.

**3.3.1.2** Prior to primer application, the surface shall be clean and free of laitance, oil and foreign materials. Tightly adhered membrane residue, which cannot be removed by scraping using heavy pressure, may be left in place. All fabric reinforcement from previous membrane systems must be completely removed.

**3.3.1.3** The concrete surface shall be inspected and approved by the Engineer and the Representative prior to priming.

**3.3.1.4** The Contractor shall perform moisture testing of the deck surface using a Contractor-supplied portable electronic surface moisture meter as described in 3.1.1. Moisture tests shall be performed at locations as determined by, and in the presence of, the Engineer. The Contractor shall determine the substrate temperature and dew point using Contractor-supplied digital instruments as described in 3.1.1. The primer shall only be applied when the moisture content of the substrate surface is 6 percent or less and when the temperature of the substrate exceeds the dew point by at least 5° F. Special attention shall be given to assure that there is no moisture present at the interface between the deck and bridge curb. The Engineer may perform additional moisture testing of the substrate.

**3.3.2 Application of adhesive primer.** The handling of components shall be performed in a safe manner as per manufacturer's recommendations. Avoid the use of an open flame near freshly applied primer.

**3.3.2.1** The primer and membrane shall be applied by a manufacturer certified applicator (Applicator). Applicators shall be individuals who have been thoroughly trained, by the manufacturer, in all aspects of application of the membrane system. Although an individual may be certified as both Applicator and Representative, the individual shall not serve in both capacities at the same time. Upon certification, the manufacturer shall issue a badge to the Applicator that includes the manufacturer's name and logo, a current photograph of the Applicator, the Applicator's full name, and the word "Applicator". The text of the badge shall be clearly printed in English. When machine method application is specified, the machine shall be operated by an Applicator who is certified to operate the machine. This certification shall be indicated on the Applicator's badge. The Applicator shall have the badge on his/her person and available for inspection at all times work is performed under this specification.

**3.3.2.2** Immediately prior to application of the primer, the deck shall be cleaned by brooms and oil-free compressed air.

**3.3.2.3** The primer shall be applied in one coat that thoroughly covers the entire surface to be membraned. The minimum primer application rate shall be 200 ft<sup>2</sup>/gal. The primer shall be applied by brush, roller or sprayer.

**3.3.2.4** The primer shall cure tack-free before application of the waterproofing membrane. Additional priming may be required depending on the surface conditions and the time between priming and application of the membrane.

## SECTION 538

**3.3.3 Membrane application.** The waterproofing membrane shall be heat welded onto the prepared substrate. Care shall be taken to assure that the membrane is completely bonded to the primed surface. The Contractor shall be responsible for protection of adjacent areas.

**3.3.3.1** When machine method is specified, the machine shall be capable of handling rolls of at least 100 square yards. The machine shall be self-propelled and shall be capable of automatically following the edge of the previously placed membrane. To minimize end-of-roll joints, only one partial roll of membrane will be allowed per bridge deck phase.

**3.3.3.2** Membrane shall be installed in a shingled pattern so that water is permitted to drain to the low areas of the deck without accumulating against seams. Laps shall be staggered at the beginning and ends of rolls and shall overlap the end of the previous roll by at least 6". Membrane shall overlap the side edge of adjacent rolls by at least 3". All laps shall be completely heat-sealed.

**3.3.3.3** Prior to suspension of work for any reason, all exposed edges shall be heated, troweled and sealed to assure that moisture cannot get under the membrane edge.

**3.3.3.4** During application, a bead of melted bitumen should be visible at the leading edge and side edges of the membrane roll, providing a visual confirmation that all surface voids have been filled and the membrane is fully adhered to the substrate.

**3.3.3.5** At the curb line, the membrane shall be heat-welded to within 1" of the curb. The curb shall be protected to prevent damage or permanent discoloring of the curb. The remaining area between the edge of the membrane and the curb, including the sloped fillet below the curb, shall be completely sealed with hot-applied rubberized asphalt material meeting the requirements of 2.3.3. The hot-applied rubberized asphalt material shall be applied so as to form a complete seal below the curb.

**3.3.3.6** Damaged membrane and adhesion test locations shall be patched or repaired in accordance with manufacturer's recommendations and with guidance from the Representative.

**3.3.4 Application of tack coat.** The membrane to be coated shall be clean and free from loose debris, moisture, or other contaminants. The Contractor shall take all necessary precautions to eliminate damage or contamination to the membrane system by vehicular traffic or by the spillage of gasoline, oil, diesel fuel, grease, hydraulic fluid or other deleterious substance. Contaminants shall be removed as per manufacturer's recommendations and with guidance from the Representative. Any material damaged by contaminants or during cleaning shall be cut out and the damaged area repaired in accordance with 3.3.3.6.

**3.3.4.1** Membrane surfaces that have been tacked shall be paved within 48 hours of application of the tack coat.

**3.3.5 Application of hot bituminous overlay.** The deck shall be paved within 3 days of membrane application unless otherwise permitted by the Engineer. The required laydown temperature of pavement overlays used in connection with heat-welded barrier membrane shall be between 290° F and 330° F. It should be noted that the laydown temperatures are extremely critical in order to preserve membrane integrity.

**3.3.5.1** Prior to paving, any blisters found in the applied membrane shall be repaired with guidance from the Manufacturer's Representative, as per manufacturer's recommendations. Typical treatment may consist of puncturing the bubble with a torch-heated pick inserted at an approximate angle of 45 degrees. A similar treatment may be necessary if bubbles appear after application of the pavement base course.

### Method of Measurement

**4.1** Barrier membrane of the type specified will not be measured, but shall be the square yard final pay quantity in accordance with 109.11 for the waterproofed surfaces within the limits shown on the plans.

**4.1.1** Repairs to the substrate or membrane system due to testing are subsidiary to the item and will not be measured.

### Basis of Payment

**5.1** Barrier membrane of the type specified is a final pay quantity item and will be paid for at the Contract unit price per square yard complete in place in accordance with 109.11.

**5.2** Protection board where required will be subsidiary.

**5.3** Hot-applied rubberized asphalt for sealing the curb line shall be subsidiary.

### Pay items and units:

538.1	Barrier Membrane, Peel and Stick (F)	Square Yard
538.2	Barrier Membrane, Peel and Stick - Vertical Surfaces (F)	Square Yard
538.5	Barrier Membrane, Heat Welded (F)	Square Yard
538.6	Barrier Membrane, Heat Welded - Machine Method (F)	Square Yard

**SECTION 541 -- WATERSTOPS****Description**

**1.1** This work shall consist of furnishing and placing waterstops in expansion, Contraction, and construction joints as shown or ordered.

**1.2 Polyvinyl chloride types.** Following are the basic types of PVC waterstops to be required under this specification:

<b>Type</b>	<b>Use</b>	<b>Description</b>
NH #1	For construction joints through which the reinforcing steel extends, and no appreciable movements are expected.	3/16" min. thick by 4" min. wide, dumbbell or ribbed (split optional), no center bulb.
NH #2	For contraction joints (keyed) without reinforcing steel or with shear steel only, where slight contraction and deflection movements are expected.	3/16" min. thick by 6" min. wide, dumbbell or ribbed (split optional), 1/4" min. I.D. by 1/2" min. O.D. center bulb.
NH #3	For expansion joints (keyed) with 1/2" of cork filler, where nominal expansion, contraction, and rotational movements are expected.	3/16" min. thick by 6" min. wide, dumbbell or ribbed (split optional), 1/4" min. I.D. by 3/4" min. O.D. center bulb.
NH #4	For expansion joints (not keyed) with 1/2 or 1" of cork filler, where appreciable expansion, contraction, rotational, and/or shear movements are expected.	3/8" min. thick by 9" min. wide, dumbbell or ribbed (split optional), 3/4" min. I.D. by 1-1/2" min. O.D. center bulb.
NH #5	For lapping over the horizontal joint between the top of the abutment backwall and the bottom of the bridge deck haunch beam at the fixed end.	2-1/2" min. by 6" min. "L" shaped, by 1/4" min. thick, ribbed on the 2-1/2" leg.

**1.2.1** The use of waterstops with larger dimensions than those shown above will be permitted with approval of the Engineer.

**Materials**

**2.1** PVC waterstops shall conform to the requirements of the United States Army Corps of Engineers Specification CRD-C 572 and shall be a product as included on the [Qualified Products List](#).

**Construction Requirements**

**3.1** The waterstops shall be installed and any necessary splicing made strictly in accordance with the manufacturer's recommended procedure, the plans, or as directed.

**3.1.1** When present, the PVC center bulb. shall be centered in the concrete joint.

**Method of Measurement**

**4.1** Waterstops will not be measured, but shall be the linear foot final pay quantity in accordance with [109.11](#) for material required as shown on the plans.

**Basis of Payment**

**5.1** Waterstops are final pay quantity items and will be paid for at the Contract unit price per linear foot complete in place in accordance with [109.11](#).

**Pay items and units:**

541.1	PVC Waterstops, NH Type 1(F)	Linear Foot
541.2	PVC Waterstops, NH Type 2(F)	Linear Foot
541.3	PVC Waterstops, NH Type 3(F)	Linear Foot
541.4	PVC Waterstops, NH Type 4(F)	Linear Foot
541.5	PVC Waterstops, NH Type 5(F)	Linear Foot

**SECTION 544 – REINFORCEMENT FOR CONCRETE****Description**

**1.1** This work shall consist of furnishing and placing reinforcement for concrete as shown on the plans or ordered.

**1.1.1** Manufacturers of reinforcing steel must participate in, and maintain compliance with, the AASHTO National Transportation Product Evaluation Program ([www.ntpep.org](http://www.ntpep.org)) that audits producers of reinforcing steel.

**Materials**

**2.1** Bar reinforcement shall be Grade 420 (Grade 60) or as shown on the plans.

**2.1.1** Billet-steel bars shall conform to AASHTO M 31.

**2.1.2** Rail-steel bars shall conform to AASHTO M 322M.

**2.2** Welded steel wire fabric shall conform to AASHTO M 55.

**2.3** Bundled reinforcement shall be used only as shown on the plans or with written permission.

**2.4 Epoxy Coated Reinforcing Steel.**

**2.4.1** Epoxy coated reinforcing steel shall meet the requirements of ASTM D3963.

**2.4.2** A written certification by the manufacturer of the powdered epoxy resin attesting to the ASTM D3963 requirements shall be provided.

**2.4.2.1** The certificate shall also contain the insignia or other similar statement that the plant is a currently approved fusion-bonded epoxy coating applicator, as defined by the Concrete Reinforcing Steel Institute (CRSI) Plant Certification Program.

**2.4.3** The epoxy coating applied to the bars shall be uniform and smooth and shall provide a film thickness of  $10 \pm 2$  mils after curing.

**2.4.4** All chair and bar supports used for the installation of epoxy coated reinforcing bars shall be epoxy-coated, vinyl-coated, or plastic-coated wire bar supports. Plastic slab bolster bar supports may be utilized for installing epoxy coated reinforcing bars. Continuous plastic bar supports between the top and bottom mats are not acceptable.

**2.5 Synthetic Fiber Reinforcement.** Synthetic fiber reinforcement shall be a product as included on the [Qualified Products List](#).

**Construction Requirements**

**3.1 Bar list.** The Department's bar list and bending schedule are made for the purpose of arriving at an estimate of quantities. The Contractor shall verify the quantity, size, and shape of the bar reinforcement against the structure drawings and make the necessary corrections, if any, before ordering. Errors in the bar list and bending schedule shall not be cause for adjustment of Contract unit price.

**3.2 Surface condition of reinforcement.** The reinforcing steel, at the time concrete is placed, shall be free of dirt, paint, oil, or other organic materials that may adversely affect or reduce bond. Metal reinforcement coated with firmly bonded rust, mill scale, or a combination of both shall be considered satisfactory provided the minimum dimensions and weight of a hand wire-brushed test specimen are not less than the applicable specification requirement. Rust or mill scale which is difficult to remove by vigorous scrubbing with a wire brush shall be considered firmly bonded to the steel.

**3.3 Bending.** Unless otherwise permitted, all reinforcing bars shall be bent cold. Bars partially embedded in concrete shall not be field bent except as shown on the plans or permitted. Only competent people shall be employed for cutting and bending, and proper appliances shall be provided for such work. Should the Engineer approve the application of heat for field bending reinforcing bars, precautions shall be taken to assure that the physical properties of the steel will not be materially altered.

**3.4 Placing and fastening.** Reinforcing steel shall be free from mortar and other objectionable substances, shall be accurately placed as shown or ordered, and shall be securely blocked and tied unless otherwise permitted. Blocking shall be by rust-resistant chairs unless otherwise permitted. Tack welding will be prohibited except upon special written approval of the Engineer. This provision also prohibits welding form ties to the reinforcement.

**3.4.1** Reinforcing steel for bridge decks shall be epoxy coated unless otherwise shown on the plans. Bridge deck reinforcing steel shall be placed on epoxy or plastic-coated steel wire supports in accordance with 2.4 and the Concrete Reinforcing Steel Institute Manual of Standard Practice. The bottom reinforcing shall be supported on type SB supports with the end of the supporting wire lapped to lock the last legs of adjoining units. The top reinforcing shall be supported by type CHCU bar supports placed between the top and bottom mats. The ends of the top supporting wire shall be lapped. The supports shall be sized and spaced to allow for the minimum cover of the reinforcing bars called for on the plans. At least 50 percent of the junctions of the reinforcing mat shall be tied.



**3.4.2** If plain reinforcing steel for the bridge deck is called for on the plans, then plastic protected or stainless steel protected supports may be used to support the bottom reinforcing mat and bright basic bar supports may be used between the top and bottom mats.

**3.4.3** Concrete shall not be placed in any member until the placement of the reinforcing steel has been inspected and approved.

**3.5 Splices.** Reinforcing steel shall be furnished in the full lengths indicated on the plans unless otherwise permitted. Splices shall be made as shown on the plans or as permitted. No splices will be permitted at points where the section does not provide a minimum distance of 2" between the splices and the nearest adjacent bar or surface of the concrete. The bars shall be rigidly clamped or wired at all splices. Sheets of metal mesh shall overlap each other sufficiently to maintain uniform strength and shall be securely fastened at the ends and edges.

**3.5.1** Splices made with mechanical connectors shall be as detailed on the plans or as permitted and shall develop an ultimate strength at least 125% of the specified yield strength of the reinforcing bar being spliced. The minimum concrete cover over the reinforcing steel as shown on the plans shall be maintained at the mechanical splice.

**3.5.1.1** The Contractor shall submit two mechanical connectors connecting two 12" sections of reinforcing steel of each size per lot per project. Connector and reinforcing steel assemblies will be tested by the Department.

**3.6** Handling, fabrication, and repair of epoxy coated reinforcing steel shall be in conformance with the applicable sections of ASTM D3963.

**3.6.1** If stored outdoors, the bars shall be covered for protection against the elements and in such a manner that condensation does not form on the bars. The bars shall not be exposed to sunlight for periods exceeding two months.

**3.7** Epoxy coated reinforcing steel which requires cutting shall be sawn. No flame-cutting will be allowed. Cut ends of bars shall be recoated with epoxy as soon as possible and before visible oxidation occurs.

**3.8 Synthetic fiber dosage rate.** The dosage rate shall be 7 lb/cy unless otherwise approved, in writing, by the Engineer.

#### Method of Measurement

**4.1** Reinforcing steel of the type specified, except reinforcing steel (roadway), will not be measured, but shall be the pound final pay quantity in accordance with 109.11 for reinforcing steel required as shown on the plans. Reinforcing steel (roadway) will be measured by the pound of reinforcing steel placed as shown on the plans or ordered. The theoretical weight of reinforcing steel will be computed based on the following table:

**Table 544-1 - Reinforcing Steel Weight - English**

Size Bar #	3	4	5	6	7	8	9	10	11	14	18
Lb. per Linear Foot	0.376	0.668	1.043	1.502	2.044	2.670	3.400	4.303	5.313	7.65	13.60

**4.2** Synthetic fiber reinforcement will not be measured but shall be the pound final pay quantity complete in accordance with 109.11 for the dosage rate specified.

#### Basis of Payment

**5.1** Reinforcing steel of the type specified, except reinforcing steel (roadway), are final pay quantity items and will be paid for at the Contract unit price per pound complete in place in accordance with 109.11. The accepted quantity of reinforcing steel (roadway) will be paid for at the Contract unit price per pound complete in place. No allowance will be made for clips, wire or other material used for fastening reinforcement in place, and no allowance will be made for additional splices or permitted substitutions.

**5.1.1** For mechanical splice bars no allowance will be made in excess of the length detailed on the plans for the additional weight required to manufacture and provide a mechanical splice to the plan specifications.

## SECTION 544

**5.2** Synthetic Fiber Reinforcement of the type specified is a final pay item and will be paid for at the contract unit price per pound complete in place in accordance with 109.11.

**5.3 Structural steel.** In reinforced concrete structures that have no structural steel bid items, structural steel will be paid for at the unit price per pound bid for reinforcing steel, unless otherwise indicated in the Contract.

### Pay items and units:

544.	Reinforcing Steel (F)	Pound
544.1	Reinforcing Steel (Roadway)	Pound
544.11	Reinforcing Steel-Mechanical Connectors (F)	Pound
544.2	Reinforcing Steel-Epoxy Coated (F)	Pound
544.21	Reinforcing Steel-Epoxy Coated Mechanical Connectors (F)	Pound
544.7	Synthetic Fiber Reinforcement (F)	Pound

**SECTION 547 -- SHEAR CONNECTORS****Description**

**1.1** This work shall consist of furnishing and welding steel shear connectors to structural steel for use in composite beam construction as shown on the plans. All requirements of this section apply to studs except for structural shapes, as noted.

**Materials****2.1 General Requirements for Studs.**

**2.1.1** Studs shall be of suitable design for arc welding to steel members with the use of automatically timed stud welding equipment. The dimensions for standard headed type round studs shall conform to Table 547-1.

**Table 547-1 - Dimensions of Standard - Type Shear Connectors**

Standard dimensions, inches		
Shank diameter	Head diameter	Minimum head height
3/4"	1-1/4"	3/8"
7/8"	1-3/8"	3/8"

**2.1.2** An arc shield (ferrule) of heat resistant ceramic or other suitable material shall be furnished with each stud. The material shall not be detrimental to the welds or cause excessive slag and shall have sufficient strength so as not to crumble or break due to thermal or structural shock before the weld is completed.

**2.1.3** A suitable deoxidizing and arc stabilizing flux for welding shall be furnished with each stud, either attached to the end of the stud or combined with the arc shield, for automatic application in the welding operation.

**2.1.4** Only studs with qualified stud bases shall be used. (The stud base is the stud tip at the welding end, including flux, and 1/8" of the body of the stud adjacent to the tip). A stud base, to be qualified, shall have passed the test prescribed in Annex VI, AASHTO/AWS D1.5. The arc shield used in production shall be the same as used in qualification tests or as recommended by the manufacturer. Qualification of stud bases in accordance with Annex VI, AASHTO/AWS D1.5, shall be at the manufacturer's expense.

**2.1.5** Finish shall be produced by heading, rolling, or machining. Finished studs shall be of uniform quality and condition, free of injurious laps, fins, seams, cracks, twists, bends, or other injurious discontinuities. Radial cracks or bursts in the head of a stud shall not be the cause for rejection, provided that the cracks or bursts do not extend more than half the distance from the head periphery to the shank, as determined by visual inspection.<sup>1</sup>

(Footnote 1. Heads of shear connectors or anchor studs are subject to cracks or bursts, which are names for the same thing. Cracks or bursts designate an abrupt interruption of the periphery of the stud head by radial separation of the metal. Such interruptions do not adversely affect the structural strength, corrosion resistance, or other functional requirements of headed studs.)

**2.1.6** Only bases qualified under Annex VI, AASHTO/AWS D1.5, shall be used. When requested by the Engineer, the Contractor shall provide the following information:

- (a) A description of the stud and arc shield.
- (b) Certification from the manufacturer that the stud base is qualified as specified in 2.1.4.
- (c) Qualification test data.

**2.2 Mechanical Requirements for Studs.**

**2.2.1** Studs shall be made from cold drawn bar stock conforming to the requirements of AASHTO M 169 (ASTM A 108), Grades 1010 through 1020, inclusive, either semi-killed or killed deoxidation.

**2.2.2** Studs shall conform to mechanical property requirements of Table 547-2. At the manufacturer's option, mechanical properties of studs shall be determined by testing either: (1) the steel after cold finishing, or (2) the full diameter finished studs.

**Table 547-2 - Mechanical Property Requirements for Studs\***

Tensile strength	60,000 psi min.
Yield strength (0.2% offset)	50,000 psi min.
Elongation (% in 50,000 psi )	20% min.
Reduction of area	50% min.

## SECTION 547

\*These are standard headed type studs in 3/4 and 7/8" diameter that are used as an essential component in composite beam design and construction.

**2.2.3** Mechanical properties shall be determined in accordance with the applicable sections of ASTM A 370. A typical test fixture shall be used similar to that shown in Figure 7.2, AASHTO/AWS D1.5.

**2.2.4** Upon request by the Engineer, the Contractor shall furnish:

- (1) The stud manufacturer's certification that the studs, as delivered, conform to the applicable requirements of 2.1 and 2.2.
- (2) Certified copies of the stud manufacturer's test reports covering the last completed set of in-plant quality control mechanical tests, required by 2.2 for each stock size delivered. The quality control test shall have been made within the six-month period before delivery of the studs.

**2.2.5** When quality control tests are not available, the Contractor shall furnish mechanical test reports conforming to the requirements of 2.2. The mechanical tests shall be on finished studs provided by the manufacturer of the studs. The number of tests to be performed shall be specified by the Engineer.

**2.2.6** The Engineer may select studs of each type and size used under the Contract as necessary for checking the requirements of 2.1 and 2.2. Furnishing these studs shall be at the Contractor's expense. Testing shall be at the Department's expense.

**2.3** Structural shapes shall conform to AASHTO M 183 (ASTM A 36).

### Construction Requirements

#### 3.1 Workmanship.

**3.1.1** Stud shear connectors shall be welded to structural steel in the field, unless directed otherwise. If studs are shop welded, suitable staging shall be installed at the erected structure to permit the Engineer to safely take the necessary grade elevations.

**3.1.2** At the time of welding, the studs shall be free from rust, rust pits, scale, oil, moisture, or other deleterious matter that would adversely affect the welding operation.

**3.1.3** The stud base shall not be painted, galvanized, or cadmium-plated prior to welding.

**3.1.4** The areas to which the studs are to be welded shall be free of scale, rust, moisture, paint, or other injurious material to the extent necessary to obtain satisfactory welds. These areas shall be cleaned by grinding to bare metal.

**3.1.5** The arc shields or ferrules shall be kept dry. Any arc shields which show signs of surface moisture from dew or rain shall be oven dried at 250 °F for two hours before use.

**3.1.6** Longitudinal and lateral spacings of stud shear connectors with respect to each other and to edges of beam or girder flanges shall not vary more than 1/2" from the location shown on the plans, except that a variation of 1" will be permitted, where required, to avoid obstruction with other attachments on the beam or where a new stud is being welded to replace a defective one. The minimum distance from the edge of a stud base to the edge of a flange shall be 1", but preferably not less than 1-1/2". The minimum spacing between adjacent studs shall be 3" center to center for 3/4" studs and 3-1/2" for 7/8" studs.

**3.1.7** After welding, arc shields shall be broken free from studs.

**3.1.8** The studs, after welding, shall be free of any discontinuities or substances that would interfere with their intended function. However, nonfusion on the legs of the flash and small shrink fissures are acceptable.<sup>2,3</sup>

(Footnote 2. The fillet weld profiles shown in Figure 3.3 AASHTO/AWS D1.5 do not apply to the flash of automatically timed stud welds.)

(Footnote 3. The expelled metal around the base of the stud is designated as flash in accordance with the definition of flash in Annex V of AASHTO/AWS D1.5. It is not a fillet weld such as those formed by conventional arc welding. The expelled metal, which is excess to the weld required for strength, is not detrimental but, on the contrary, is essential to provide a good weld. The containment of this excess molten metal around a welded stud by the ferrule (arc shield) assists in securing sound fusion of the entire cross section of the stud base. The stud weld flash may have nonfusion in its vertical leg and overlap on its horizontal leg; and it may contain occasional small shrink fissures or other discontinuities that usually form at the top of the weld flash with essentially radial or longitudinal orientation, or both, to the axis of the stud. Such nonfusion on the vertical leg of the flash and small shrink fissures are acceptable.)

#### 3.2 Technique.

**3.2.1** Studs shall be welded with automatically timed stud welding equipment connected to a suitable source of direct current straight polarity power. Welding voltage, current, time, and gun settings for lift and plunge should be set at optimum settings,

based on past practice, recommendations of stud and equipment manufacturer, or both. AWS C5.4, Recommended Practices for Stud Welding, should also be used for technique guidance.

**3.2.2** If two or more stud welding guns are to be operated from the same power source, they shall be interlocked so that only one gun can operate at a time, and so that the power source has fully recovered from making one weld before another weld is started.

**3.2.3** While in operation, the welding gun shall be held in position without movement until the weld metal has solidified.

**3.2.4** Stud welding shall not be done when the base metal temperature is below 32°F or when the surface is wet or exposed to falling rain or snow.

**3.2.5 Fillet weld option.** At the option of the Contractor, studs may be fillet welded by the shielded metal arc process, provided the following requirements are met:

**3.2.5.1** Welding is performed by a qualified welder, as per 550.3.16.

**3.2.5.2** The minimum fillet size to be used shall be 5/16" for 3/4 and 7/8" diameter studs.

**3.2.5.3** Welding shall be done with low hydrogen electrodes (E7018), 5/32 or 3/16" in diameter.

**3.2.5.4** The stud base shall be prepared so that the base of the stud fits against the base metal.

**3.2.5.5** All rust and mill scale at the location of the stud shall be removed from the base metal by grinding. The end of the stud shall also be clean.

**3.2.5.6** The base metal to which studs are welded shall be preheated to 150 °F minimum.

**3.2.5.7** Fillet welded studs shall be visually inspected as per AASHTO/AWS D1.5, 6.6.2.

**3.3 Stud application qualification requirements.** Studs which are shop or field applied in the flat (down-hand) position to a planar and horizontal surface are deemed prequalified by virtue of the manufacturer's stud base qualification tests (Annex VI, AASHTO/AWS D1.5), and no further application testing is required. The limit of flat position is defined as 0-15 degree slope on the surface to which the stud is applied.

### 3.4 Stud Production Control.

#### 3.4.1 Pre-Production Testing.

**3.4.1.1** Before production welding with a particular set-up<sup>4</sup> and with a given size and type of stud, and at the beginning of each day's or shift's production, testing shall be performed on the first two studs that are welded. The stud technique may be developed on a piece of material similar to the production member in thickness and properties. If actual production thickness is not available, the thickness may vary plus or minus 25%. All test studs shall be welded in the same general position as required on the production member (flat).

(Footnote 4. Set-up includes stud gun, power source, stud diameter, gun lift and plunge, total welding lead length, or changes greater than ± 5% in current (amperage) and time.)

**3.4.1.2** Instead of being welded to separate material, the test studs may be welded on the production member, except when separate plates are required by 3.4.1.5.

**3.4.1.3** The test studs shall be visually examined. They shall exhibit full 360 degree flash.

**3.4.1.4** In addition to visual examination, the test shall consist of bending the studs, after they are allowed to cool, to an angle of approximately 30 degrees from their original axes by either striking the studs on the head with a hammer or placing a pipe or other suitable hollow device over the stud and manually or mechanically bending the stud. At temperatures below 50 °F, bending shall preferably be done by continuous slow application of load.

**3.4.1.5** If on visual examination the test studs do not exhibit 360 degree flash, or if on testing failure occurs in the weld zone of either stud, the procedure shall be corrected, and two more studs shall be welded to separate material or on the production member and tested in accordance with the provisions of 3.4.1.3 and 3.4.1.4. If either of the second two studs fails, additional welding shall be continued on separate plates until two consecutive studs are tested and found to be satisfactory before any more production studs are welded to the member.

**3.4.1.6 Production welding.** Once production welding has begun, any changes made to the welding set-up as determined in 3.4.1 shall require that the testing in 3.4.1.3 and 3.4.1.4 be performed prior to resuming production welding.

## SECTION 547

**3.4.1.7** In production, studs on which a full 360 degree flash is not obtained may, at the option of the Contractor, be repaired by adding the minimum fillet weld as required by 3.2.5 in place of the missing flash. The repair weld shall extend at least 3/8" beyond each end of the discontinuity being repaired.

**3.4.2 Operator qualification.** The pre-production test required by 3.4.1, if successful, shall also serve to qualify the stud welding operator. Before any production studs are welded by an operator not involved in the pre-production set-up of 3.4.1, the operator shall have the first two studs welded by him tested in accordance with the provisions of 3.4.1.3 and 3.4.1.4. When the two welded studs have been tested and found satisfactory, the operator may then weld production studs.

### 3.4.3 Repairs.

**3.4.3.1** If an unacceptable stud has been removed from a component subjected to tensile stresses, the area from which the stud was removed shall be ground smooth and flush. Where in such areas the base metal has been pulled out in the course of stud removal, shielded metal arc welding with low hydrogen electrodes in accordance with the requirements of 3.2.5 shall be used to fill the pockets and the weld surface shall be flush.

**3.4.3.2** In compression areas of members, if stud failures are confined to shanks or fusion zones of studs, a new stud may be welded adjacent to each unacceptable area in lieu of repair and replacement on the existing weld area (See 3.1.6). If base metal is pulled out during stud removal, the repair provisions shall be the same as for tension areas except that when the depth of discontinuity is the lesser of 1/8" or 7% of the base metal thickness the discontinuity may be blended smoothly by grinding in lieu of filling with weld metal. Where a replacement stud is to be provided, the base metal repair shall be made prior to welding the replacement stud. Replacement studs shall be tested by bending to an angle of approximately 15 degrees from their original axes. The areas of components exposed to view in completed structures shall be made smooth and flush where a stud has been removed.

## 3.5 Fabrication and Verification Inspection Requirements for Studs.

**3.5.1** If a visual inspection reveals any stud that does not show a full 360 degree flash or any stud that has been repaired by welding, such stud shall be bent to an angle of approximately 15 degrees from its original axis. The method of bending shall be in accordance with 3.4.1.4. The direction of bending for studs with less than a 360 degree flash shall be opposite to the missing portion of the flash.

**3.5.2** The Engineer shall select a reasonable number of studs to be subjected to the tests specified in 3.5.1.

**3.5.3** The bent stud shear connectors and other studs to be embedded in concrete that show no sign of failure shall be acceptable for use and left in the bent position. All bending and straightening when required shall be done without heating, before completion of the production stud welding operation, except as otherwise provided in the Contract.

**3.5.4** If, in the judgment of the Engineer, studs welded during the progress of the work are not in accordance with the provisions of this specification, as indicated by inspection and testing, corrective action shall be required of the Contractor. At his own expense, the Contractor shall make the set-up changes necessary to ensure that studs subsequently welded will meet specification requirements.

**3.5.5** At the option and the expense of the Department, the Contractor may be required, at any time, to submit studs of the types used under the Contract for a qualification check in accordance with the procedures of Annex VI, AASHTO/AWS D1.5.

## 3.6 Welding Structural Shapes.

**3.6.1** Structural shapes shall be fastened to the girders by shop or field welding, as shown on the plans.

**3.6.2** Welding shall be performed in accordance with the requirements of 3.2.5.

### Method of Measurement

**4.1** Shear connectors will not be measured, but shall be the each final pay quantities in accordance with 109.11 for connectors required as shown on the plans.

### Basis of Payment

**5.1** Shear connectors are a final pay quantity item and will be paid for at the Contract unit price per each complete in place in accordance with 109.11.

#### Pay item and unit:

547.	Shear Connectors (F)	Each
------	----------------------	------

**SECTION 548 -- ELASTOMERIC BEARINGS****Description**

**1.1** This work shall consist of furnishing and placing elastomeric bearing pads for structural members. The pads shall be fabricated in conformity with the dimensions shown on the plans.

**1.2** This work shall consist of furnishing and placing elastomeric bearing assemblies for structural members. Assemblies shall include elastomeric bearing pads, masonry and sole plates, connection bolts, anchor bolts, nuts and washers, shim plates and fabric bearing pads. The assemblies shall be fabricated in conformity with the dimensions shown on the plans.

**Materials**

**2.1** Elastomeric bearing pads shall be furnished according to the Plans and as specified herein.

**2.2** Elastomeric compound shall be 100 percent virgin natural rubber meeting or exceeding the requirements of AASHTO LRFD Bridge Construction Specifications, Section 18.2 – Elastomeric Bearings.

**2.3** Internal steel plates shall conform to AASHTO M 270 (ASTM A709/), Grade 36 or 50 (or ASTM A36, A572).

**2.4** External load bearing plates shall conform to AASHTO M 270 (ASTM A709/A 709M), Grade 50W (345W).

**2.5** Preformed fabric bearing pads for external bearing plates shall conform to 550.2.6, Type 1.

**2.6** Anchor bolts shall conform to 550.2.5.

**2.7** The surface finish of bearing surfaces shall conform to AASHTO LRFD Bridge Construction Specifications, Section 11.4.6.

**2.8 Quality Assurance.**

**2.8.1** The Contractor shall furnish certified test results indicating compliance with each physical and chemical property specified.

**Construction Requirements**

**3.1** The fabrication, testing and installation shall be performed in accordance with the requirements of the Plans, AASHTO LRFD Bridge Construction Specifications, Section 14, and Section 18.

**3.2** The Contractor shall submit all shop fabrication drawings for approval in accordance with 105.02.

**3.2.1** Fabrication shall not begin until written approval of the submitted shop fabrication drawings has been received from the Department.

**3.3** The elastomeric bearing pads and assemblies shall be set on a carefully prepared surface as required by the applicable provisions of 550.3.15.5.

**3.4** The anchor bolts shall be installed as required by the applicable provisions of 550.3.15.4.

**3.5 Elastomeric bearings.** Following the manufacture of these bearings and verification of the internal steel laminates, the pin groove openings shall be coated with an approved asphaltic sealer and the space filled with silicone caulking.

**Method of Measurement**

**4.1** Elastomeric bearing pads or elastomeric bearing assemblies will not be measured, but shall be the Each final pay quantities in accordance with 109.11 for bearings required as shown on the plans. When more than one structure is included in the Contract, separate item numbers will be used for each separate and complete structure.

**Basis of Payment**

**5.1** Elastomeric bearing pads or elastomeric bearing assemblies are final pay quantity items and will be paid for at the Contract unit price per each complete in place in accordance with 109.11.

**Pay items and units:**

548.1X	Elastomeric Bearing Pads (F)	Each
548.2X	Elastomeric Bearing Assemblies (F)	Each

**SECTION 550 -- STRUCTURAL STEEL****Description**

**1.1 General.** This work shall consist of furnishing, fabricating, painting if required, transporting, and erecting all structural steel, bridge shoes, and other materials in accordance with these Specifications, the contract documents, and as shown on the plans.

**1.1.1** References within this section are identified by a section number (e.g. 3.15.5 Setting Bearings), and references to sections of AASHTO LRFD Bridge Construction Specifications (current edition and interim specifications) are identified by the abbreviation AASHTO followed by the section number (e.g. AASHTO 11.3.1.7).

**Materials**

**2.1 General.** Materials for steel structures shall be as specified in the current edition and interim specifications of the AASHTO LRFD Bridge Design Specifications, unless otherwise specified herein.

**2.1.1** Materials shall conform to the AASHTO “Standard Specifications for Transportation Materials and Methods of Sampling and Testing”, in accordance with current editions and interim specifications, and as modified herein.

**2.2 Structural steel.**

Steel shall be furnished according to the following specifications, or as otherwise specified on the plans.

**2.2.1 General.**

**2.2.1.1** Structural steel shall meet the Standard Specifications for General Requirements for Rolled Structural Steel Bars, Plates, Shapes, and Sheet Piling, ASTM A 6.

**2.2.1.2** Unless otherwise specified, structural carbon steel shall be furnished for all structural steel. Structural carbon steel shall conform to AASHTO M 270 (ASTM A 709), Grade 36.

**2.2.2** High-strength, low-alloy (HSLA) structural steel shall conform to AASHTO M 270 (ASTM A 709) Grade 50 or Grade 50W (weathering), or HPS 50W, as shown on the plans.

**2.2.3 Charpy V-notch impact requirements.** All structural steel used in main load-carrying member components subject to tensile stress shall conform to the requirements for Zone 2 of AASHTO M 270 for the longitudinal Charpy V-notch impact tests.

**2.2.3.1** These impact requirements are mandatory for members including but not necessarily limited to rolled beams, welded cover plates, webs and tension flanges of built-up girders, flange and web splice plates, longitudinal stiffener plates, cross frames and their connection plates on horizontally curved girders, and other members as shown on the plans.

**2.3 Paint.**

**2.3.1** Paint shall conform to NEPCOAT Qualified Products List A or B, unless superseded by a Special Provision for Item 550.

**2.4 High Strength Bolts.****2.4.1 Blank.****2.4.2 Specifications.**

**2.4.2.1 Bolts.** High strength bolts for structural steel joints including suitable nuts and plain hardened washers shall meet the requirements of ASTM A 325 as amended and modified herein. High strength bolts, nuts, and washers used with weathering steel shall be Type 3.

**2.4.2.1.1** When high strength galvanized bolts are specified, they shall conform to ASTM B 695 Class 50 for mechanically-deposited galvanizing. Use galvanized fasteners where structural steel is painted.

**2.4.2.1.2** The use of ASTM A 490 bolts will not be permitted without authorization by the Administrator, Bureau of Bridge Design.

**2.4.2.2 Nuts.** Nuts shall conform to ASTM A 563.

**2.4.2.3 Washers.** All washers shall be hardened steel and shall conform to ASTM F 436 and these specifications.

**2.4.2.4 Direct Tension Indicators (DTI).** All DTI's shall conform to the requirements of ASTM F 959 Type 325, except that DTI's shall not exceed Rockwell hardness C35. The DTI supplier shall certify that testing has been performed on equipment required by ASTM F 959.

**2.4.2.4.1** DTI's shall be furnished “galvanized” (i.e. mechanically zinc coated) unless noted otherwise. For use with weathering steel, DTI's shall be furnished as weathering steel or “painted” (i.e. mechanically galvanized and epoxy coated or baked epoxy).



2.4.2.4.2 DTI's which incorporate a self-indicating feature to signal sufficient bump compression are not permitted.

### 2.4.3 Manufacturing.

2.4.3.1 **Dimensions.** Bolt and nut dimensions shall conform to the dimensions given in Table 550-1 (see Fig. 1) and shall conform to the requirements for Heavy Hexagon Structural Bolts and for Heavy Semi-Finished Hexagon Nuts given in the following specifications:

Bolts	Heavy Hex Structural Bolts	ANSI/ASME B18.2.1
Nuts	Heavy Hex Nuts	ANSI/ASME B18.2.2

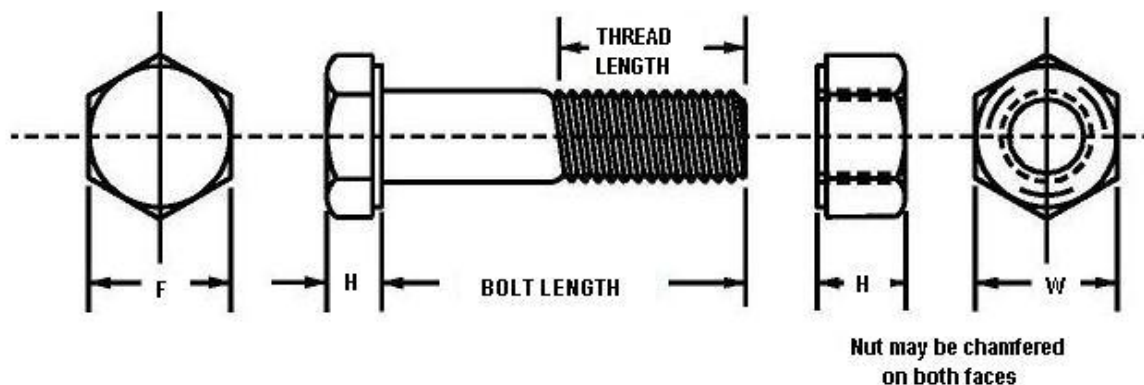

**FIGURE 1 - HEAVY STRUCTURAL BOLT AND HEAVY NUT**

**Table 550-1 - Bolt and Nut Dimensions**

Nominal Bolt Size, D	Heavy Hex Structural Bolts inches			Heavy Hex Nuts inches	
	Width Across Flats, F	Height H	Thread Length	Width Across Flats W	Height H
1/2	7/8	5/16	1	7/8	31/64
5/8	1-1/16	25/64	1-1/4	1-1/16	39/64
3/4	1-1/4	15/32	1-3/8	1-1/4	47/64
7/8	1-7/16	35/64	1-1/2	1-7/16	55/64
1	1-5/8	39/64	1-3/4	1-5/8	63/64
1-1/8	1-3/16	11/16	2	1-13/16	1-7/64
1-1/4	2	25/32	2	2	1-7/32
1-3/8	2-3/16	27/32	2-1/4	2-3/16	1-11/32
1-1/2	2-3/8	15/16	2-1/4	2-3/8	1-15/32

2.4.3.2 **Threads.** Threads for bolts and nuts shall conform to the following:

		External	Internal
Unified Coarse Thread Series, UNC	ANSI/ASME B.1.1	2A	2B

The 8-pitch thread series 8 UN shall be used on bolts larger than 1”.

### 2.4.3.3 Bolts.

2.4.3.3.1 **Hardness.** Hardness for bolt sizes 1/2 to 1” inclusive shall be as noted below:

ASTM A325 Bolts

Hardness Number					
		Brinell		Rockwell C	
Bolt Size	Min.	Max.	Min.	Max.	
1/2 to 1 in, incl.	253	319	25	34	

**2.4.3.3.2 Bolt markings.** All bolts shall be identified with an “ A 325” marking on the top of the bolt head and also a symbol identifying the manufacturer (see Fig. 2). Type 3 bolts shall be identified by an underlined “A 325”.

**2.4.3.3.3 Bolt length.** The required bolt length shall be determined by adding the value shown in Table 550-2 to the grip (i.e. the total thickness of all connected material, without washers). For each hardened flat washer that is used add 5/32”, and for each beveled washer add 5/16” The values of Table 550-2 provide appropriate allowance for manufacturing tolerances, and also provide for full thread engagement (i.e. having the end of the bolt at least flush with the face of the nut) with an installed heavy hex nut. The length thus determined shall be adjusted to the next longer standard (1/4 in) length.

TYPE	A 325		A 490	
	BOLT	NUT	BOLT	NUT
1	<p>(1)</p>			
2	WITHDRAWN IN 1991	SAME AS TYPE 1	<p>NOTE MANDATORY 6 RADIAL LINES AT 30</p>	SAME AS TYPE 1
3	<p>NOTE MANDATORY UNDERLINE</p>	<p>(3)</p>	<p>NOTE MANDATORY UNDERLINE</p>	<p>(3)</p>

- (1) ADDITIONAL OPTIONAL 3 RADIAL LINES AT 120 MAYBE ADDED
- (2) TYPE 3 ALSO ACCEPTABLE
- (3) ADDITIONAL OPTIONAL MARK INDICATING WEATHERING GRADE MAY BE ADDED

FIGURE 2 - REQUIRED MARKING FOR BOLT AND NUT

Nominal Bolt Size Inches	To Determine Required Bolt Length Add to Grip - Inches
1/2	11/16
5/8	7/8
3/4	1
7/8	1-1/8
1	1-1/4
1-1/2	1-1/2
1-1/4	1-5/8
1-3/8	1-3/4
1-1/2	1-7/8

2.4.3.4 Nuts.

**2.4.3.4.1 Plain nuts.** Plain (ungalvanized) nuts shall be grade DH.

**2.4.3.4.2 Weathering nuts.** Nuts used with ASTM A 325 Type 3 bolts shall be DH3.

**2.4.3.4.3 Nut markings.** Nuts shall be marked with the corresponding grade symbol DH3 on one face. Grade C nuts shall be marked on one face with three circumferential marks 120 degrees apart. Grade C3 nuts shall be marked the same as class grade C nuts along with the numeral 3.

**2.4.3.4.4 Galvanized nuts.** Nuts to be galvanized shall be grade DH.

**2.4.3.4.5 Overtapping nuts to be galvanized.** Nuts that are to be galvanized shall be tapped oversize the minimum amount required for proper assembly. The amount of overtap in the nut shall be such that the nut will assemble freely on the bolt in the coated condition and shall meet the overtapping requirements of ASTM A 563 and the required rotational-capacity test.

**2.4.3.4.6 Lubrication.** Galvanized nuts shall be lubricated with a lubricant containing a water soluble visible dye of a color that contrasts with the color of the galvanizing.

**2.4.3.5 Washers.** Type 3 washers shall be used with ASTM A 325 Type 3 bolts and shall be identified with the numeral 3 stamped on one face.

**2.4.3.5.1** Circular hardened washers shall be flat and smooth and their nominal dimensions shall conform to the dimensions given in Table 550-3. Where necessary, washers may be clipped on one side to a point not closer than 7/8 of the bolt diameter from the center of the washer.

**Table 550-3 - Dimensions for Hardened Washers F436<sup>a</sup>**

Circular Washers					Square Beveled Washers for American Standard Beams and Channels		
Bolt D	Nominal Outside Diameter	Nominal Diameter of Hole	Thickness		Minimum Side Dimension	Mean Thickness	Slope or Taper in Thickness
			Min	Max			
1/2	1-1/16	17/32	0.097	0.177	1-3/4	5/16	1:6
5/8	1-5/16	21/32	0.122	0.177	1-3/4	5/16	1:6
3/4	1-15/32	13/16	0.122	0.177	1-3/4	5/16	1:6
7/8	1-3/4	15/16	0.136	0.177	1-3/4	5/16	1:6
1	2	1-1/8	0.136	0.177	1-3/4	5/16	1:6
1-1/8	2-1/4	1-1/4	0.136	0.177	2-1/4	5/16	1:6
1-1/4	2-1/2	1-3/8	0.136	0.177	2-1/4	5/16	1:6
1-3/8	2-3/4	1-1/2	0.136	0.177	2-1/4	5/16	1:6
1-1/2	3	1-5/8	0.136	0.177	2-1/4	5/16	1:6
1-3/4	3-3/8	1-7/8	0.178 <sup>b</sup>	0.28 <sup>b</sup>			
2	3-3/4	2-1/8	0.178 <sup>b</sup>	0.28 <sup>b</sup>			
Over 2 to 4 incl.	2D-1/2	D+1/8	0.24 <sup>c</sup>	0.34 <sup>c</sup>			

<sup>a</sup>Dimensions in inches. (Tolerances as noted in Table 550-2, ASTM F 436.)

<sup>b</sup>3/16" nominal. <sup>c</sup>1/4" nominal.

## 2.4.4 Testing.

### 2.4.4.1 Testing Bolts.

**2.4.4.1.1 Proof load test.** Proof load tension tests of full size bolts are required in accordance with Method 1, Length Measurement, of ASTM F 606. The minimum frequency of tests shall be as specified in ASTM A 325 paragraph 9.2.4.

**2.4.4.1.2 Wedge test.** Wedge tension tests, ASTM F 606 paragraph 3.5, on full size bolts are required in accordance with ASTM A 325 paragraph 10.1.1 (If bolts are to be galvanized, tests shall be performed after galvanizing.) The minimum frequency of tests shall be as specified in ASTM A 325.

**2.4.4.1.3** If galvanized bolts are supplied, the thickness of the zinc coating shall be measured. Measurements shall be taken on the wrench flats or top of bolt head.

## SECTION 550

### 2.4.4.2 Testing Nuts.

**2.4.4.2.1 Proof load test.** Proof load tension tests are required for nuts in accordance with paragraph 4.2 of ASTM F 606. The minimum frequency of tests shall be as specified in ASTM A 563 or ASTM A 194 paragraph 7.1.2.1. If nuts are to be galvanized, tests shall be performed after galvanizing, overtapping and lubricating.

**2.4.4.2.2** If galvanized nuts are supplied, the thickness of the zinc coating shall be measured. Measurements shall be taken on the wrench flats.

### 2.4.4.3 Testing Galvanized Washers.

**2.4.4.3.1** If galvanized washers are supplied, hardness testing shall be performed after galvanizing. (Coating shall be removed prior to taking hardness measurements.)

**2.4.4.3.2** If galvanized washers are supplied, the thickness of the zinc coating shall be measured.

**2.4.4.4 Rotational-capacity test for fastener assemblies.** Rotational-capacity tests are required and shall be performed on all black or galvanized (after galvanizing) bolt, nut and washer assemblies by the manufacturer or distributor prior to shipping. Washers are required as part of the test. The following shall apply:

**2.4.4.4.1** Except as modified herein, the rotational-capacity test shall be performed in accordance with the requirements of ASTM A 325.

**2.4.4.4.2** Each combination of bolt production lot, nut lot, and washer lot shall be tested as an assembly.

**2.4.4.4.3** A rotational-capacity lot number shall be assigned to each combination of lots tested.

**2.4.4.4.4** The minimum frequency of testing shall be two assemblies per rotational-capacity lot.

**2.4.4.4.5** The bolt, nut and washer assembly shall be assembled in a Skidmore-Wilhelm Calibrator or an acceptable equivalent device. For short bolts which are too short to be assembled in the Skidmore-Wilhelm Calibrator, see section 2.4.4.4.9.

**2.4.4.4.6** The minimum rotation, from a snug tight condition (10% of the specified proof load), shall be:

240 deg. (2/3 turn)	for bolt lengths	≤ 4D
360 deg. (1 turn)	for bolt lengths	> 4D and < 8D
480 deg. (1-1/3 turn)	for bolt lengths	> 8D

Notes:

1. The bolt length is measured from the underside of the head to the end of the bolt.
2. D = nominal bolt diameter (inches).

**2.4.4.4.7** The tension reached at the above rotation shall be equal to or greater than 1.15 times the required minimum bolt installation tension. Assemblies which do not meet this tension fail the test. The minimum bolt installation tension and the required tension for the turn test are shown below:

Bolt Diameter (Inches)	1/2	5/8	3/4	7/8	1	1-1/8	1-1/4	1-3/8	1-1/2
Min. Req'd. Bolt Installation Tension (kips)	12	19	28	39	51	56	71	85	103
Req'd Turn Test Tension (kips)	14	22	32	45	59	64	82	98	118

**2.4.4.4.8** After the required minimum bolt installation tension listed above has been exceeded, one reading of tension and torque shall be taken and recorded. The torque value shall conform to the following:

$$\text{Torque} \leq 0.25 \text{ PD}$$

where, Torque = measured torque, foot-pounds  
P = measured bolt tension, pounds  
D = bolt diameter, feet

**2.4.4.4.9** Bolts that are too short to test in a Skidmore-Wilhelm Calibrator may be tested in a steel joint. The tension requirement of section 2.4.4.4.7 need not apply. The maximum torque requirement of section 2.4.4.4.8 shall be computed using a value of P equal to the turn test tension shown in the table in section 2.4.4.4.7.

**2.4.4.5 Reporting.**

**2.4.4.5.1 Results.** The results of all tests (including zinc coating thickness) required herein and in the appropriate AASHTO specifications shall be recorded on the appropriate document.

**2.4.4.5.2 Location.** The location where tests are performed and date of tests shall be reported on the appropriate document.

**2.4.4.6 Witnessing.** The tests need not be witnessed by an inspection agency; however, the manufacturer or distributor that performs the tests shall certify that the results recorded are accurate.

**2.4.5 Documentation.****2.4.5.1 Mill Test Reports.**

**2.4.5.1.1** Mill test reports shall be furnished for all mill steel used in the manufacture of the bolts, nuts, or washers.

**2.4.5.1.2** Mill test reports shall indicate the place where the material was melted and manufactured.

**2.4.5.2 Manufacturer Certified Test Reports - (MCTR).**

**2.4.5.2.1** The manufacturer of the bolts, nuts, and washers shall furnish test reports (MCTR) for the item furnished.

**2.4.5.2.2** Each MCTR shall show the relevant information required in accordance with 2.4.4.5.

**2.4.5.2.3** The manufacturer performing the rotational-capacity test shall include on the MCTR:

- (a) The lot number of each of the items tested.
- (b) The rotational-capacity lot number as required in 2.4.4.4.3.
- (c) The results of the tests required in 2.4.4.4.
- (d) The pertinent information required in 2.4.4.5.2.
- (e) A statement that MCTR for the items are in conformance to this specification and the appropriate AASHTO specifications.
- (f) The location where the bolt assembly components were manufactured.

**2.4.5.3 Distributor Certified Test Reports - (DCTR).**

**2.4.5.3.1** The DCTR shall include MCTR above for the various bolt assembly components.

**2.4.5.3.2** The rotational-capacity test may be performed by a distributor (in lieu of a manufacturer) and reported on the DCTR.

**2.4.5.3.3** The DCTR shall show the results of the tests required in 2.4.4.4.

**2.4.5.3.4** The DCTR shall also show the pertinent information required in 2.4.4.5.2.

**2.4.5.3.5** The DCTR shall show the rotational-capacity lot number as required in 2.4.4.4.3.

**2.4.5.3.6** The DCTR shall certify that the MCTR are in conformance to this specification and the appropriate AASHTO specifications.

**2.4.6 Shipping.**

**2.4.6.1** Bolts, nuts, and washers from each rotational-capacity lot shall be shipped in the same container. If there is only one production lot number for each size of nut and washer, the nuts and washers may be shipped in separate containers. Each container shall be permanently marked with the rotational-capacity lot number such that identification will be possible at any stage prior to installation.

**2.4.6.2** The appropriate mill test reports, MCTR or DCTR shall be supplied to the State with two copies of each.

**2.5 Anchor rods.**

Anchor rods for bridge shoes shall be fabricated from deformed billet-steel concrete-reinforcement bars conforming to AASHTO M31, (ASTM A 615), Grade 60. As an alternative, anchor rods shall conform to ASTM A449 or F1554 (Grade 55) material (all-thread for diameters up to 1 1/2" and swedged for diameters over 1 1/2").

**2.5.1** The details of the anchor rods shall be as shown on the plans. Threads shall be cut or rolled into the specified length of the bar which has been turned to a uniformly circular cross-sectional area of the specified diameter. Anchor rod threads shall be unified coarse thread series, UNC-2A as specified in ANSI/ASME B1.1. Bars shall be furnished as follows:

## SECTION 550

Specified Thread Diameter	Reinforcing Bar Size
1"	No. 9
1-1/4"	No. 11
1-1/2"	No. 14

**2.5.2 Nuts.** Nuts shall be hex nuts with mechanical properties conforming to ASTM A 307. Threads for nuts shall be unified coarse thread series, UNC-2B as specified in ANSI/ASME B1.1.

**2.5.3 Washers.** Washers shall be circular washers of commercial quality, unless otherwise specified.

**2.5.4 Galvanizing.** Anchor rods, nuts, and washers shall be galvanized after fabrication and conform to AASHTO M 232 (ASTM A 153).

**2.5.5 Tightening anchor rods.** See 3.15.5.6.

### 2.6 Preformed Fabric Bearing Pads.

**2.6.1 Type 1.** Preformed fabric bearing pads shall meet the requirements of AASHTO LRFD Bridge Construction Specifications, Section 18.10 "Fabric-reinforced Elastomeric Bedding and Masonry Plates" and –the most current version of MIL-C-882. Pads used to set bridge bearing masonry plates on concrete masonry (see 3.15.5) shall be single sheets approximately 1/8" thick.

**2.6.1.1** The preformed fabric pads shall be composed of multiple layers of 8 oz/sy cotton or cotton-polyester 50-50 blend duck impregnated and bound with high-quality natural rubber or of equivalent and equally suitable materials compressed into resilient pads of uniform thickness and vulcanized. The number of plies shall be such as to produce the specified thickness after compression vulcanizing. The finished pads shall withstand compression loads perpendicular to the plane of the laminations of not less than 10,000 psi without detrimental reduction in thickness or extrusion.

**2.6.1.2** The thread filling count of the duck shall be  $40 \pm 2$  threads per 1" and the warp count shall be  $50 \pm 1$  threads per 1". The pad shall meet the requirements of the load deflection and permanent set compression tests.

**2.6.2 Type 2.** Preformed fabric bearing pads with a polytetrafluorethylene (PTFE) surface for use in expansion bearing assemblies shall consist of the following two components:

- (1) a Type 1 preformed fabric pad meeting the requirements of 2.6.1 of a thickness specified on the plans;
- (2) a PTFE bearing element (minimum 1/16" thick) conforming to the requirements of 2.10 and which is bonded to a rigid confining substrate. The substrate shall limit flow (elongation) of the confined PTFE to less than 4% under load of 2000 psi for 15 minutes at 78 °F for a 2 by 3" test sample, per ASTM D261, Deformation Under Load.

**2.6.3 Acceptance.** Bearing pads shall be accepted based upon receipt of a Certificate of Compliance stating that the products comply with the requirements of 2.6.1 or 2.6.2, as applicable, including test results performed by an independent testing laboratory.

### 2.7 Stainless steel plate.

**2.7.1** Stainless steel for use in expansion bearing assemblies shall be 16 gage and conform to ASTM A 240 Type 304 with a #8 mirror finish on the side in contact with the PTFE surface.

### 2.8 Steel tubing.

**2.8.1** Steel tubing shall conform to the requirements of ASTM A 500, Grade B.

### 2.9 Galvanizing.

When galvanizing is shown on the plans or specified, it shall meet the requirements of AASHTO M 111 (ASTM A 123) for fabricated steel products, and AASHTO M 232 (ASTM A 153) for hardware items other than high strength bolts (such as anchor rods, nuts and washers).

#### 2.9.1 Galvanizing Touch-up and repairs.

**2.9.1.1** The total repair area shall be less than 0.25% of the area of an individual member, or the member shall be rejected and regalvanized. [The repair area definition is comparable to Rust Grade 7 in ASTM D610, *Standard Test Method for Evaluating Degree of Rusting on Painted Steel Surfaces.*]

**2.9.1.2** Repair damaged galvanizing and bare steel surfaces in accordance with ASTM A780, Standard Practice for Repair of Damaged Hot Dipped Galvanized Coatings, Annex A2. Thoroughly clean damaged areas to produce a clean, bare and dry bright metal surface with a roughened profile and feather into the edges of adjacent undamaged galvanizing. Use a power sanding disk per SSPC-SP3. For bolts use a thorough hand wire brushing and SP1 cleaning as a minimum.

**2.9.1.3** Apply an approved organic zinc-rich repair paint containing 92 percent (min.) zinc by weight in the dry film, according to the manufacturer's recommendations, in two to four coats to a thickness equivalent to the surrounding galvanizing. Silver paint, brite paint, or aluminum paint is not acceptable.

**2.9.1.4** The repair to the galvanizing may be a liquid and brushed on or an aerosol and sprayed, whichever is appropriate to achieve an aesthetic finish and as long as the coats, cure, and minimum thickness of the original system are achieved. The Contractor shall provide a dry film thickness gage and check the thickness of the repair areas. Touch-ups shall be such that the repair is not noticeably visible from a distance of six feet.

## **2.10 PTFE surfaces for bearings.**

PTFE for use in expansion bearing assemblies shall be 100 percent virgin (unfilled) polytetrafluorethylene polymer conforming to AASHTO LRFD Bridge Design Specifications, Section 14.7.2 "PTFE Sliding Surfaces" and AASHTO, LRFD Bridge Construction Specifications, Section 18.8.2 "Materials" and Section 18.8.3 "Fabrication Requirements".

## **Construction Requirements**

### **3.1 General.**

#### **3.1.1 Specifications.**

**3.1.1.1** Fabrication, painting, transportation and erection of steel structures shall conform to the latest edition and interim Specifications of the AASHTO LRFD Bridge Construction Specifications unless otherwise specified herein.

**3.1.1.2** Welded fabrication shall conform to the AASHTO Welding Specifications, namely, the latest edition of the AASHTO/AWS D1.5 "Bridge Welding Code" and all Interim Revisions published by AASHTO as of the bid opening date, unless otherwise specified herein.

#### **3.1.2 Guidelines.**

**3.1.2.1** The latest edition of the following AASHTO/NSBA Steel Bridge Collaboration documents shall provide procedural guidance to the work unless directed otherwise in the governing specifications or by the Department:

- (a) G1.1 Shop Detail Drawings Review/Approval Guidelines
- (b) G1.2 Design Drawing Presentation Guidelines
- (c) G1.3 Shop Detail Drawing Presentation Guidelines
- (d) S2.1 Steel Bridge Fabrication Guide Specification, 2<sup>nd</sup> edition
- (e) S4.1 Steel Bridge Fabrication QC/QA Guide Specification
- (f) S8.1 Guide Specification for Coating Systems with Inorganic Zinc-Rich Primer
- (g) G9.1 Steel Bridge Bearing Design and Detailing Guidelines
- (h) G12.1 Guidelines for Design for Constructability

**3.1.3 Approval.** Prior to performing any work under Section 550, the fabricator must have received approval for all shop fabrication drawings, welding procedures, and any special Contract requirements. The fabricator shall bear full responsibility and costs for all materials ordered or work performed prior to approval of the shop fabrication drawings or written authorization to proceed from the Engineer.

**3.1.4 Quality of workmanship and finish.** The workmanship and finish shall be first class and equal to the best practice in modern bridge shops. Shearing, flame cutting, bolting, and welding shall be neatly and accurately done, and all portions of the work exposed to view shall be neatly finished.

**3.1.5 Main members.** The main members of steel structures are defined to include but not be limited to rolled beams, girder flange and web plates, truss components, arches, floor beams, stringers, bridge shoes, cross frames carrying direct live loads, cover plates, bearing stiffeners, longitudinal stiffeners, transverse stiffeners, splice plates, cross frames on horizontally curved bridges, and end connecting or gusset plates for any of these members. The Contract plans may also designate other members as main members.

### **3.2 Fabricator qualification.**

Structural steel for bridges furnished under Section 550 shall be fabricated in a plant/shop that has established proof of its competency and responsibility by being registered and certified in accordance with the American Institute of Steel Construction, Inc. (AISC) Quality Certification Program.

**3.2.1 AISC Category - Major Steel Bridges (CBR).** AISC Category CBR Certification is required for the fabrication of bridge structures incorporating welded plate girders, trusses, arches, welded floor beams, rolled beams with cover plates, rolled beams with bolted field splices, horizontally curved rolled beams, cross frames for curved bridges, and pot bearings. The fabrication of fracture critical members requires an AISC Fracture Critical Endorsement.

## SECTION 550

**3.2.2 AISC Category - Simple Steel Bridges (SBR).** AISC Category SBR or CBR certification is required for the fabrication of simple straight unspliced rolled beam bridges, structural members for bridge repair or rehabilitation work, bridge shoes, high mast poles, overhead sign support structures, modular and finger-type expansion joints, and pedestrian truss bridges.

**3.2.3 AISC Category - Bridge and Highway Metal Component Manufacturers (CPT).** AISC Category SBR or CPT certification is required for the fabrication of strip seal and compression seal expansion joints, drains, scuppers, bridge rail, bridge approach rail, grid decks, non-structural items, and ancillary members requiring minimal welding and fabrication.

**3.2.4 Shop Painting Qualification.** Fabricators supplying painted or metallized products shall be certified with the AISC Certification Standard for Shop Application of Complex Protective Coating Systems (SPE) [formerly, Sophisticated Paint Endorsement P1 (enclosed shop)], or The Society for Protective Coatings (SSPC) QP3 program. For duplex coating and metallizing see the requirements in [Section 708 Appendix A, B, and C](#).

### 3.3 Shop Fabrication Drawings.

**3.3.1** The fabricator shall furnish shop fabrication drawings of all details of fabrication of all structural metals required under the Contract, for approval in accordance with [105.02](#). The shop fabrication drawings shall show details, dimensions, size and grade of materials, match marking diagrams for field connections, procedures, and other information necessary for the complete fabrication and erection of the work.

**3.3.2** Shop fabrication drawings shall meet the requirements of AASHTO 11.2.1. All shop fabrication drawings shall be neatly and accurately drawn. All shop fabrication drawings shall show both the detailer's and checker's initials as an indication that the details have been checked for accuracy.

**3.3.3** The shop fabrication drawings shall be furnished sufficiently in advance of fabrication to allow for review, resubmission, and approval by the Engineer.

**3.3.4** The shop fabrication drawings shall be furnished as a complete set for each structure. They may be furnished according to a sequence in partial sets if approved in advance by the Engineer.

**3.3.5** The fabricator shall submit three sets of the shop drawings to the Engineer for approval. After receiving approval, the fabricator shall supply the Engineer with six distribution sets of revised working drawings. If a design consultant is involved in the project, four approval sets and seven distribution sets of working drawings shall be supplied.

**3.3.6** Fabrication shall not begin until written approval of the submitted shop fabrication drawings has been received from the Engineer.

**3.3.7** Deviation from the approved shop fabrication drawings will not be permitted without the written order or consent of the Engineer.

**3.3.8** Detailed welding procedure specifications shall be considered an integral part of shop fabrication drawings and shall be submitted for approval along with the shop fabrication drawings. The shop fabrication drawings and welding procedures shall clearly indicate the welding procedure corresponding to each weld shown.

**3.3.9** The fabricator shall expressly understand that the Engineer's review of shop fabrication drawings submitted by the fabricator covers requirements for strength and arrangement of component parts, and the Engineer assumes no responsibility for errors in dimensions.

**3.3.10 Originals.** Original shop fabrication drawings, corrected 'as-built', shall be delivered to the Department before final payment will be made.

### 3.4 Material Identification.

**3.4.1** The identification of steels during fabrication shall be according to AASHTO 11.4.1, except that steel stamping shall not be used for material identification.

#### 3.4.2 Mill Test Reports.

**3.4.2.1** Two copies of certified heat number identified mill test reports showing physical test results and chemical analysis for all main and secondary structural members shall be furnished to the Engineer. Mill test reports shall be traceable to the piece mark and identified by the State project name, project number, and bridge number.

**3.4.2.2** Any material not properly identified shall not be incorporated in the work.

**3.4.2.3** Receipt of acceptable mill test reports by the Inspector is required before fabricated material may be released for shipment. Receipt of acceptable mill test reports by the Engineer is a prerequisite for payment for any fabricated material.

**3.4.3 Substitutions.** Materials other than those shown on shop fabrication drawings reviewed by the Engineer may be used under the following provisions:



- (a) that the substitute material is equal or greater in strength and properties to the material originally shown;
- (b) that the substitution is approved by the Engineer; and
- (c) that the substitution is made at no additional cost to the Department.

#### 3.4.4 Die Stamping.

**3.4.4.1** Die stamping shall not be permitted on main members for radiographic testing, welder identification, heat number transfer or quality assurance acceptance. Girder piece marks may be made with low stress stamps on the web at mid-depth at the end of the girder and on splice plates outside the bolt pattern, or as approved.

**3.4.4.2** When die stamping is permitted, low stress dies (i.e. dies manufactured to produce impressions that are rounded at the bottom of the impression rather than sharp edged) shall be used and shall conform to the following requirements:

Nominal Character Size inches	Minimum Character Face Radius inches
1/8	0.007
3/16	0.008
1/4	0.01

### 3.5 Preparation of Base Metals.

**3.5.1** Thermal cutting of structural steel shall conform to the requirements of the AASHTO Welding Specifications. Thermal cutting of main members shall be done only when the steel in the area of the cut is above 40° F and in a surface-dry condition except when using plasma arc.

**3.5.2** All thermal cut surfaces shall be produced using a mechanically guided torch, unless otherwise approved. Thermal cut surfaces produced by manually guided torch, when allowed, shall be made with a suitable guiding device and be smoothed by grinding.

**3.5.3 Reentrant corners.** Reentrant corners shall be formed to a radius of not less than 1". On main material a 2" minimum radius shall be provided whenever possible. All reentrant corner edges shall be ground to a 1/16" radius.

**3.5.4 Thermal cutting of high strength steel, 50 ksi min. yield strength.** The fabricator shall take steps to ensure that the thermal cut edges of main material subject to tensile stresses are not hardened by the cutting process. This may be achieved by preheating, post heating or control of the burning process. Flame cut edges of webs which are incorporated into final submerged arc web-to-flange fillet welds need not be tested for hardness.

**3.5.4.1** Thermal cut edges found to have a Rockwell Hardness Value of C30 or greater will be considered unacceptable. A portable Rockwell Hardness Tester will be employed by the fabricator and witnessed by the Inspector to determine conformance with these requirements. Unacceptably hard surfaces shall be removed by grinding, machining, or approved heat treating procedures.

**3.5.4.2** All Rockwell Hardness testing shall be performed on the thermal cut edge at the mid-thickness location of the plate. Testing shall be performed randomly along the length of each plate.

**3.5.5 Weld repairs.** Approved weld repairs of notches and gouges in thermal cut plate edges shall be performed in accordance with the requirements of the AASHTO Welding Specifications and 3.6.9.

**3.5.6 Facing of bearing surfaces.** The surface finish of bearings shall meet the surface roughness requirements of AASHTO 11.4.6.

**3.5.6.1** Sliding bearings with a surface roughness greater than ANSI 60 shall be machined or ground or machined and ground so that the lay of the cut does not restrict movement in the longitudinal direction. This includes the rotating portion of the top of rockers and rocker sockets in sole plates.

**3.5.7 Flange plates.** All flange plates shall be furnished with either thermal cut edges or Universal Mill plates. When thermal cutting flange plates, both edges shall be cut simultaneously to minimize distortion.

**3.5.8 Web plates.** Web plates of built up girders shall be thermal cut to produce the required camber.

**3.5.9 Splice plates and gusset plates.** Flange and web splice plates shall be furnished with thermal cut edges, although web splice plates 5/8" or less in thickness may be made of sheared plates.

**3.5.10 Stiffeners and connection plates.** Stiffeners and connection plates welded transverse to girder webs and flanges may be furnished with sheared edges provided their thickness does not exceed 5/8". Universal Mill plate may be used provided its thickness does not exceed 1". All other stiffener and connection plates shall be furnished with thermal cut edges.

## SECTION 550

### 3.5.11 Bending of Plates.

**3.5.11.1** Bending of steel plates and bars shall meet the requirements of AASHTO 11.4.3.3, as modified herein, and shall be performed in a manner such that no cracking occurs. Before bending, the corners of the plate shall be rounded to a radius of 1/16" throughout the portion of the plate at which the bending is to occur. After bending is complete, all surfaces of the bent area shall be magnetic particle inspected.

**3.5.11.2 Plates of Primary Members.** Plates of primary members may be cold-bent, or hot-bent as approved. Cold-bending shall be performed gradually in a slow, controlled, uniform manner with roller equipment built for the purpose and adequate for the task, and by facilities experienced in the work and approved by the Department. Bending by piston-driven "cold-gagging" is not permitted.

**3.5.11.2.1** Hot-bending of primary members shall use heating methods and equipment as described in 550.3.10. Hot-bending is required for bend radii of 2 ft. or less. The area to be bent shall be heated for the full width of the plate and for a distance of at least six times the thickness of the plate. No bending force shall be applied until this area is heated to a temperature between 900° and 1,150° F.

**3.5.11.3 Plates of Secondary Members.** Plates of secondary members, e.g. cross frame gusset plates on a skewed bridge, may be cold-bent or hot-bent.

**3.5.11.4 Rolled Beams and Fabricated Members.** Rolled beams, welded girders, and fabricated primary members shall use heating methods for cambering, sweep, and straightening according to 550.3.10.

### 3.6 Shop Welding.

#### 3.6.1 Welding Procedures.

**3.6.1.1** The fabricator shall submit welding procedure specifications to the Administrator, Bureau of Bridge Design and receive written approval of the procedures prior to the start of fabrication.

**3.6.1.2** All welding shall conform to the approved welding procedure specifications.

**3.6.1.3** Welding procedures shall be provided to the welders and welding operators and shall be posted on welding machines for use during production.

**3.6.1.4 Welding Procedure Specifications.** Form N-2 of Annex N of the AASHTO Welding Specifications shall be required for use in both qualified and prequalified written welding procedure specifications.

#### 3.6.2 Qualification of Welders and Welding Operators.

**3.6.2.1** Welding shall be performed by only prequalified welders, welding operators, and tackers; and shall be qualified by the applicable tests as described in the AASHTO Welding Specifications.

**3.6.2.2** Welder and welding operator qualification tests shall be the responsibility of the fabricator. However, the qualification tests shall be witnessed and approved by an independent, qualified testing/inspection agency.

**3.6.2.3** The fabricator shall maintain a file of the welder and welding operator qualification test records and make this file available for examination to the Administrator, Bureau of Bridge Design, upon request. Welder qualification test records shall be Form III-4 of Annex III of the AASHTO Welding Specifications or equal.

**3.6.2.4** For each project, the fabricating shop shall submit a letter of compliance to the Engineer listing by name all welders and welding operators employed on the fabrication of material for the project. The letter shall certify that these welders or welding operators have been prequalified and that they have been continuously engaged in the welding process for which they are qualified with no lapses in such employment in excess of 6 months since being prequalified.

#### 3.6.3 Welding Processes.

**3.6.3.1 Main members.** Welding of main load-carrying members and attachments (3.1.5) shall be performed using only submerged arc (SAW) and shielded metal arc processes (SMAW).

**3.6.3.2 Submerged arc welding.** All principal welds on main members shall be made with the submerged arc process, including all welding of butt splices, flange-to-web welds, connection or stiffener plates to webs, and attaching cover plates.

#### 3.6.3.3 Shielded Metal Arc Welding.

**3.6.3.3.1** The use of the manual shielded metal-arc process shall be limited to welding connection plates to rolled beams, welding bridge shoes, repairs, tack welding, joints under 2 ft. in length, minor detail attachments, and other limited welding applications where the use of submerged arc welding equipment is impractical because of limited access or the isolated location and short length of welds involved. Shielded metal arc welding may be used for submerged arc weld repairs.

**3.6.3.3.2** Only low hydrogen electrodes will be allowed. Proper electrode storage must be strictly adhered to according to the AASHTO Welding Specifications.

**3.6.3.4 Flux cored arc welding.** The flux cored arc welding process (FCAW) may be used for members which are not main load-carrying members, such as bridge shoes, cross frames, diaphragms, steel bridge rail, steel light poles, scuppers, expansion joints, and approved secondary material, unless directed otherwise.

**3.6.3.5 Gas metal arc welding.** The gas metal arc welding process (GMAW) may be used for welding the products listed in 3.6.3.4, unless directed otherwise.

**3.6.3.6** Electroslag (ESW) and electrogas (EGW) welding processes are not permitted.

**3.6.3.7 Calibration.** The fabricator shall periodically calibrate the amperage and voltage meters on welding machines, or, alternatively, verify meter readings by the use of a tong ammeter and volt meter external to the welding machine at regular intervals, or as requested by the Inspector.

**3.6.3.8 Arc strikes.** Arc strikes outside the area of permanent welds are prohibited on any base metal. Arc strikes are to be ground smooth, and on main member material the area shall be checked for soundness by magnetic particle testing at all locations.

### 3.6.4 Welding AASHTO M 270 Grade 50 W (weathering) steel.

**3.6.4.1 Deposited weld metal.** When AASHTO M 270 Grade 50 W is specified, deposited weld metal shall have the atmospheric corrosion resistance and coloring characteristics that match that of the base metal.

**3.6.4.2 Minimum heat input.** The minimum heat input during welding of M 270 Grade 50W steel shall be determined by the procedure qualification test parameters.

**3.6.5 Preheat and interpass temperature.** Preheating is required for all welding when the temperature of the base metal is below the minimum specified in the AASHTO Welding Specifications (see Table 550-4). The base metal shall be preheated in such manner that the parts on which the weld metal is being deposited are above the specified minimum temperature for a distance equal to the thickness of the part being welded but not less than 3" in all directions from the point of welding. In joints involving combinations of base metals, preheat shall be as specified for the higher strength metal being welded. Temperatures above the minimum specified may be required for highly restrained welds. Preheat temperatures shall be monitored at the locations specified above.

**Table 550-4 - Minimum Preheat and Interpass Temperature\***

Thickness of thickest part at point of welding	M 270 Gr 36
	M 270 Gr 50 M 270 Gr 50W
	°F
To 3/4 in	50
Over 3/4 to 1-1/2"	70
Over 1-1/2 to 2-1/2 in	150
Over 2-1/2"	225

\*A minimum preheat temperature of 150° F [max. 400° F ] will be required for all field welding, irrespective of existing temperatures.

### 3.6.6 Weather Conditions.

**3.6.6.1** Welding shall not be performed when surfaces to be welded are wet from condensation, rain, snow or ice, when rain or snow is falling on the surfaces to be welded, or during periods of high wind unless the welder and the work are properly protected. Welding shall not be permitted when the ambient temperature is below 32°F. (The ambient temperature does not mean the ambient environmental temperature but the temperature in the immediate vicinity of the weld.)

**3.6.6.2** Shop areas for automatic and semiautomatic welding shall be kept at a temperature not lower than 40° F for at least one hour before work begins and at all times when work is being performed.

### 3.6.7 Tack Welds.

**3.6.7.1** The provisions of the AASHTO Welding Specifications shall govern the use of tack welds.

## SECTION 550

**3.6.7.2** Temporary welds that are not incorporated into the final weld are not permitted, except as shown on the shop fabrication drawings and approved. All the quality requirements of final welds shall apply to such temporary welds including preheat. Temporary welds shall be removed by grinding smooth and flush, the area inspected by dye penetrant testing, and tested for hardness as required.

**3.6.7.3** Tack welds shall be thoroughly cleaned before final welding.

**3.6.7.4** Tack welds shall be sufficiently small to ensure that they do not produce objectionable changes in the appearance of the weld surface or result in a decrease in penetration. Tack welds larger than permitted shall be reduced by grinding before final welding is begun.

**3.6.7.5** Unless otherwise approved, tack welds shall be made by E7018 electrodes.

**3.6.7.6** Tack welds that contain cracks shall be removed and rewelded before placing final welds.

**3.6.7.7** Preheat is required for tack welds which are remelted and incorporated into any final weld made by a process other than submerged arc.

### **3.6.8 Weld Terminations.**

**3.6.8.1 Run-on and run-off extension plates.** Welds shall be terminated (started and stopped) at the end of a joint in a manner that will ensure sound welds. Whenever possible, this shall be done by the use of weld tabs (run-on and run-off extension plates) placed in a manner that will duplicate the joint detail being welded. Weld tabs shall be of sufficient length in the direction of the weld that potential crater cracks do not extend into the edge of the member, but not less than 2”.

**3.6.8.2 Weld tab installation.** Weld tabs shall be installed in a manner that will prevent cracks from forming in the area where the weld tab is joined to the member. The preferred method is by tack welding inside the joint where the tack welds will be consumed in producing the final weld.

**3.6.8.3 Weld tab removal.** Weld tabs shall be removed upon completion and cooling of the weld. The ends of the welds shall be made smooth and flush with the edges of the abutting parts. The edges of flanges and webs at the ends of groove-weld butt in tension joints shall be inspected by dye penetrant testing or magnetic particle testing.

**3.6.8.4 Fillet weld terminations.** All fillet welds must have full throat and no unfilled craters at the beginning and end of the weld. Fillet weld terminations shall have a smooth, rounded profile free of sharp irregularities. Grinding required to correct irregular profiles shall be done with a burr grinder.

### **3.6.9 Repairs.**

**3.6.9.1** Weld repairs shall be performed in accordance with the requirements of the AASHTO Welding Specifications.

**3.6.9.2 Approval.** Prior to performing any corrective weld repairs, the Fabricator shall submit a proposed repair procedure to the Department and receive approval. Prior approval does not have to be obtained in writing, unless required by the Engineer. However, a written record shall be made of all repair work performed and locations.

**3.6.9.3 Multiple repairs.** The maximum number of repairs to unacceptable defects in main member welds shall be three; i.e. the number of times a weld may be opened, repaired, and resubmitted for nondestructive testing, unless otherwise approved by the Administrator, Bureau of Bridge Design.

**3.6.9.4** Structural members shall not be accepted for placement in the structure until all repairs have been made and accepted.

**3.6.9.5 Preheat.** All weld repairs shall be performed with a minimum preheat and interpass temperature of 150° F.

**3.6.9.6 Air carbon-arc gouging.** Air carbon-arc gouging shall be followed by thorough grinding, that is, grinding to all-over bright metal.

**3.6.9.7 Testing.** All weld repairs in tension areas shall be inspected for soundness by dye penetrant testing and shall be retested by the method originally used. The repair of a repair (i.e. successive repairs in a given location) at a main member groove-weld location in tension shall be inspected for soundness by radiographic, ultrasonic and dye penetrant testing after waiting for an interval of 72 hours. All groove-weld repairs shall be ground smooth and flush prior to testing.

**3.6.10 Stud welding.** Studs shop welded to pier nose angles, scuppers and expansion joints as required on the plans shall meet the requirements of 547, Shear Connectors and AASHTO Welding Specifications, Chapter 7.

## **3.7 Shop Inspection.**

**3.7.1 Quality assurance inspection.** The Department will inspect the fabrication of structural steel on bridge projects which involve main load-carrying members, including welded girders and rolled beams. This quality assurance inspection will include the examination of materials, welding, nondestructive testing, work procedures, painting, and the final fabricated product.

**3.7.1.1** Fabrication shall only be done in the presence of an authorized inspector representing the Department. The Department's authorized quality assurance inspector is herein referred to as the Inspector.

**3.7.1.2** The Engineer may waive shop inspection for secondary structural components and make a complete inspection at a later stage in the construction sequence.

**3.7.2 Notice.** The fabricator shall give ample notice (two weeks minimum) of the beginning of work so that arrangements can be made for inspection. No materials shall be fabricated before the Engineer has been so notified.

**3.7.3 Authority.** The Inspector shall have the authority to reject any material or workmanship that does not meet the requirements of the Contract documents. In case of dispute, the Contractor may appeal to the Engineer, whose decision shall be final.

**3.7.3.1** Inspection at the shop is intended as a means of facilitating the work and avoiding errors, and it is expressly understood that it will not relieve the fabricator from any responsibility in regard to imperfect material or workmanship and the necessity for replacing the same.

**3.7.4 Acceptance.** The Inspector shall affix the acceptance stamp of his company to the structural steel when it is ready for shipment and has been properly loaded. This acceptance mark shall be made by paint or ink stamp placed near the erection mark of the piece. Boxed or bundled material may be stamped on durable tags.

**3.7.4.1** Receipt of acceptable mill test reports by the Inspector and the completion of all inspections are prerequisite for fabricated material being approved and released for shipment.

**3.7.4.2** The fabricator shall present the Inspector with a copy of the shipping invoice to be stamped for verification of inspection and approval of steel items prior to shipment.

**3.7.4.3** The Inspector's acceptance implies that at the time of shipment from the shop, it was the opinion of the Inspector that the structural steel was fabricated from accepted materials by approved processes, painted and loaded for shipment in accordance with the Contract requirements. The Inspector's stamp of approval for shipment does not imply that the structural material will not be rejected by the State if subsequently found to be defective.

**3.7.5 Facilities.** The fabricator shall furnish facilities for the quality assurance (QA) inspection of materials and workmanship in the shop. The facilities for inspection shall include office accommodations separate from fabricator personnel and convenient to the work equipped with adequate and working lighting, electrical outlets, heating, ventilation and if necessary air conditioning, a desk and chair, a metal file cabinet, plan rack, and a telephone available for the exclusive use of the Inspector. The fabricator shall provide and permit the QA inspector access to and use of a fax machine, and broadband email connection.

### **3.7.6 Cooperation.**

**3.7.6.1** The fabricator shall fully cooperate with the Inspector in the inspection of the work in progress. This shall include the storage of members completed during the Inspector's absence, in such a manner, that he can completely and safely inspect the finished work.

**3.7.6.2** The fabricator shall allow the Inspector unrestricted access to the necessary parts of the shop during working hours. Work done while the Inspector has been refused access shall be automatically rejected.

**3.7.6.3** The fabricator shall furnish the Inspector with as many copies of mill orders as may be requested.

**3.7.7 Testing.** The fabricator shall perform nondestructive testing required by the Contract, the specifications, and as detailed in 3.8.

**3.7.7.1** Nondestructive testing shall only be done in the presence of the Inspector.

**3.7.7.2** The fabricator shall notify the Inspector 48 hours in advance if nondestructive testing is to be performed at times other than regular daylight hours of the regular workweek.

**3.7.7.3** The fabricator shall comply with all requests of the Inspector to correct deficiencies in materials and workmanship as provided in the Contract documents.

### **3.8 Nondestructive Testing of Welds.**

**3.8.1 Responsibility.** The fabricator is responsible for providing nondestructive testing of welds, including equipment, supplies, and technicians. Nondestructive testing shall be performed as required by the AASHTO Welding Specifications.

**3.8.2 Personnel qualification.** Personnel performing and interpreting nondestructive tests (i.e. magnetic particle, dye penetrant, radiographic, and ultrasonic) shall be certified Level II individuals qualified in accordance with the American Society for Nondestructive Testing Recommended Practice No. SNT-TC-1A, or equivalent, as required by the AASHTO Welding Specifications.

## SECTION 550

**3.8.3 Witness.** Nondestructive testing shall be performed in the presence of the Inspector, unless permitted otherwise. The fabricator shall advise the Inspector of nondestructive testing schedules. The Inspector shall be given 48 hours advance notice of any nondestructive testing that is to be performed at times other than regular daylight hours of the regular work week. Radiographic test films shall be made available to the Inspector in a timely manner for review.

**3.8.4 Reports.** Nondestructive test reports shall be identified as to structure member and location of weld or welds and shall also list all the defective welds, the number of times defective welds were corrected, and the amount of additional inspection required. All radiographs shall become the property of the Department and shall be turned over to the Department on completion of the fabrication, or when otherwise requested by the Inspector.

**3.8.4.1 Forms.** Nondestructive testing shall be reported on forms from the Appendices of the AASHTO Welding Specifications, or equal. Use Annex F Form F4 for ultrasonic testing, Annex N Form N6 for radiographic testing, and Form N7 for magnetic particle testing.

**3.8.5 Zone of stress reversal.** For the purpose of determining nondestructive testing requirements in beams and girders, the zone of stress reversal shall be assumed to extend 10 ft. each side of the field splice location (or secondarily, the dead load point of contra flexure), unless otherwise detailed on the Contract plans.

**3.8.6 Visual inspection.** All welds shall be visually inspected.

### **3.8.7 Magnetic Particle Testing.**

**3.8.7.1** Magnetic particle testing shall be performed on welds as described in the AASHTO Welding Specifications, including web-to-flange, bearing stiffener-to-web, cover plate to flange, bridge shoes, and cross frame welds and connection plate-to-web welds on horizontally curved girders.

**3.8.7.2** When magnetic particle testing is used, the procedure and technique shall be in accordance with the dry powder magnetic particle examination of welds using the yoke method or prod method in accordance with ASTM E 709.

**3.8.7.3 Yoke Method.** The yoke method shall be performed in conformance with ASTM E709 using half-wave rectified direct current (DC) or alternating current (AC). DC electromagnetic yokes shall have a lifting force of at least 50 lb. at the maximum pole spacing that will be used over four inches.

**3.8.7.4 Prod Method.** When the prod method is performed on AASHTO M 270 Gr 50 or Gr 50W steel or other steels with minimum specified yield strength of 50 ksi or greater, aluminum prods shall be used on the test equipment. Copper prods shall not be used on such steels. Arcing shall be minimized by following the proper testing procedures.

**3.8.8 Radiographic testing.** Radiographic testing shall be performed on groove welded butt joints in main members. Radiographic testing shall be performed in accordance with the requirements of the AASHTO Welding Specifications.

**3.8.8.1** All identification marks required on butt welds for radiographic purposes shall be made with paint. Steel die stamping shall not be permitted.

**3.8.8.2** Edge blocks shall be used when radiographing butt welds greater than 1/2" thickness. The edge blocks shall have a length sufficient to extend beyond each side of the weld centerline for a minimum distance equal to the weld thickness, but not less than 2", and shall have a thickness equal to or greater than the thickness of the weld. The minimum width of the edge blocks shall be equal to half the weld thickness, but not less than 1" The edge blocks shall be centered on the weld against the plate being radiographed, allowing not more than 1/16" gap for the minimum specified length of edge blocks. Edge blocks shall not be tack welded. Edge blocks shall be made of radiographically clean steel and the surface shall have a finish of 125 micro-inches (ANSI 3 μm) or smoother.

**3.8.9 Ultrasonic testing.** Ultrasonic testing shall not be used as a substitute for radiographic testing. Ultrasonic testing may be used by the fabricator to determine the extent of discontinuities, laminations and inclusions discovered in any base metal.

**3.8.10 Dye penetrant testing.** Dye penetrant testing shall be used to inspect transverse fillet welds (3.9.3.2), ends of groove weld butt splices (3.6.8), weld repairs (3.6.9), arc strikes (3.6.3.8), and may be used to supply additional information at the discretion of the Inspector. Dye penetrant testing shall only be performed when the steel is between the temperatures of 40 to 110 °F. After dye penetrant testing is completed and approved, discoloration shall be removed from the steel with suitable solvents.

## **3.9 Assembly of Shop Welded Connections.**

**3.9.1 Plate girder assembly.** Flange and web plates for welded girders shall be completely shop welded separately before assembly as shown on the plans.

**3.9.2 Butt splice welds.** All butt splice groove welds shall be made flush and smooth by grinding in the longitudinal direction of the girder.

### 3.9.3 Assembly of Vertical Stiffeners.

**3.9.3.1** Intermediate stiffeners, bearing stiffeners, and connection plates shall be snipped at the corners and welded to the web and flanges as specified on the Contract plans. The fillet welds connecting the stiffener or connection plate to the web shall be started at the end of the stiffener that is adjacent to the tension flange and progress toward the compression flange. The fillet welds shall extend to within 1/2" of all snipped corners and shall not be wrapped around the end of the plate in the snipped corner. Care shall be taken to prevent the stiffener welds from intersecting the continuous flange to web welds. The maximum possible clearance between intersecting welds is desired. All fillet welds must have full throat and no unfilled craters at the beginning and end of the weld. Localized undercut of the stiffener at the point where the welding machine is started or stopped shall not require repair unless severe in the opinion of the Inspector.

**3.9.3.2 Undercut.** When fillet weld toe undercut is less than 1/32" deep and transverse to the primary stress, the undercut may be corrected by grinding to a smooth profile not to exceed 1/32" deep. Repair by grinding shall be inspected by dye penetrant testing.

**3.9.3.3** Before welding, there shall be no gap between the web and the intermediate stiffeners, bearing stiffeners, or connection plates in excess of 3/32".

**3.9.3.4** Intermediate stiffeners and connection plates may be cut 3/16" short and then assembled with the stiffener tight against the tension flange and the weld size at the compression flange increased to include the gap. Stiffeners shall not be driven in place with sufficient force to distort the flange, web or stiffener. Stiffeners which show evidence of being under compressive stress, such as waviness along the length of the stiffener after fitting is completed, shall be removed and corrected prior to final welding.

**3.9.3.5** Tack welds shall be so placed that weld passes do not start or stop on the tack weld.

**3.9.4 Bearings.** Sole plates of beams and girders shall have full contact with the flanges, and the bearing surface shall be smooth and true and shall be truly perpendicular to the web of the member. Curved sole plates shall make full-line bearing with masonry plates, which line, unless otherwise shown on the plans, shall be at right angles to the web of the member.

**3.9.4.1 Sole plates.** The sole plate-to-flange fillet welds which are on opposite sides of a common plane of contact shall not be wrapped but terminated 1/4" short of the common corner.

**3.9.5** Longitudinal stiffener plates shall be continuous and shall be butt spliced, if required, with full penetration groove welds, and 100% inspected by radiographic testing before being welded to the web.

**3.9.6 Cross frames.** Cross frame welds which are on opposite sides of a common plane of contact shall not be wrapped but terminated 1/4" short of the common corner.

### 3.10 Heat Curving, Cambering, and Straightening.

**3.10.1** Straightening rolled or bent material, cambering, and heat curving rolled beams and welded girders shall conform to the requirements of AASHTO 11.4.7 and 11.4.12.2, respectively.

#### 3.10.2 Temperature.

**3.10.2.1** When heating is permitted, the maximum allowable temperature of the steel shall be 1,200 °F (a dull red) for AASHTO M 270 (ASTM A 709) steels with a specified minimum yield point equal to or less than 50 ksi, e.g. Gr 36, 50, and 50W. When the application of heat to AASHTO M 270 Grade 70W and 100W steels is permitted by the Engineer, the temperature shall not exceed 1,050 °F nor shall the temperature exceed 900 °F at weld metal or within 6" of weld metal, nor shall the heat be applied directly to weld metal.

**3.10.2.2** Heating temperatures shall be controlled with temperature indicating crayons. The fabricator shall provide temperature indicating crayons manufactured for 600°, 1,000°, 1,100° and 1,250 °F. Heat measurements shall be made after the heating flame has been removed from the steel.

**3.10.3 Artificial cooling.** Quenching with water or water and air will not be permitted. Cooling with dry compressed air will be permitted after the steel has cooled to 600 °F.

**3.10.4 Destructive heating.** Any heating procedure which causes a portion of the steel to be heated to a temperature greater than 1,250 °F shall be considered destructive heating. Destructive heating shall automatically cause the rejection of the steel. Steel rejected for destructive heating shall be investigated for reacceptance, repair, or replacement by tests ordered by the Department.

**3.10.5 Damage.** Any method of handling, supporting, or loading that causes the member to distort permanently (yield without the application of heat) will result in rejection of the member. All nondestructive tests to evaluate damage and any corrective work ordered by the Department to compensate for overstressing shall be performed by the fabricator.

## SECTION 550

**3.10.6 Sequence of operations for heat curving.** Members shall be heat curved prior to performing the following work, unless otherwise approved by the Department.

- (a) Attachment of lateral gusset plates.
- (b) Attachment of longitudinal stiffeners.
- (c) Welding of intermediate stiffeners and connection plates to the flanges.

### 3.10.7 Heating patterns.

**3.10.7.1** Heating patterns shall be marked on the flange surfaces prior to heating.

**3.10.7.2** Heating shall be conducted to bring the steel within the planned pattern to a temperature between 900° and 1,150 °F as rapidly as possible without overheating the steel.

**3.10.7.3** The heating torches shall be manipulated to guard against general and surface overheating. When heating thick plates, it may be necessary to occasionally interrupt heating for periods of less than one minute to allow the heat to soak into the flange and avoid surface overheating.

**3.10.8 Verification of camber and sweep.** After fabrication of rolled beams and welded girders is complete, the fabricator shall measure the camber in the unloaded position (with the web horizontal) and, if applicable, the sweep (with the web vertical) at the 1/4 points as a minimum. The fabricator shall furnish a report to the Department listing the camber and sweep measurements and certify that they are within specified tolerances.

## 3.11 Connections Using High Strength Bolts.

### 3.11.1 General.

**3.11.1.1** Structural joints shall be assembled using ASTM A 325 high strength bolts tightened to a high tension.

**3.11.1.2** Bolts, nuts, washers and direct tension indicators (DTIs) shall conform to the requirements of 2.4.

**3.11.1.3** Standard holes (1/16" larger than diameter of bolt) shall be used in high strength bolted connections. Proposed use of oversize or slotted holes shall be subject to approval by the Administrator, Bureau of Bridge Design. (See Table 550-5)

**Table 550-5 - Nominal Hole Dimensions  
Hole Dimensions, inches**

	Standard (Dia.)	Oversize (Dia.)	Short Slot (Width x Length)	Long Slot (Width x Length)
1/2	9/16	5/8	9/16 x 11/16	9/16 x 1-1/4
5/8	11/16	13/16	11/16 x 7/8	11/16 x 1-9/16
3/4	13/16	15/16	13/16 x 1	13/16 x 1-7/8
7/8	15/16	1-1/16	15/16 x 1-1/8	15/16 x 2-3/16
1	1-1/16	1-1/4	1-1/16 x 1-5/16	1-1/16 x 2-1/2
>1-1/8	d + 1/16	d+ 5/16	(d + 1/16) x (d+ 3/8)	(d+ 1/16) x (2.5 x d)

**3.11.1.4** The assembly of structural joints with high strength bolts shall conform to the requirements of AASHTO 11.5.6. Installation and tightening of high strength bolts shall be in accordance with AASHTO 11.5.6.4. Of particular importance is obtaining the snug tight condition (as defined in 3.11.6.4.2) before final tightening.

**3.11.1.5** All bolted connections are classified as slip critical, unless noted otherwise on the plans.

**3.11.1.6** Bolts shall be tightened to the required pretension by the direct tension indicator (DTI) method according to the procedures and requirements of 3.11.6.7. At the written request of the Contractor and with approval of the Engineer, bolts may be tensioned to the required tension by the turn-of-nut method according to 3.11.6.4 or the calibrated-wrench method, provided the procedures required in 3.11.6.5 are carefully and thoroughly followed.

**3.11.1.7** An approved tension calibrator (i.e. tension measuring device) shall be required at each job site during bolt installation. Periodic testing (at least once each working day) shall be performed to assure compliance with the installation test procedures required herein. Bolts that are too short for the tension calibrator may be tested using direct tension indicators (DTIs). The DTIs must be calibrated in the tension calibrator using longer bolts.

**3.11.1.8** The rotational-capacity test described in 2.4 shall be performed on each rotational-capacity lot prior to the start of bolt installation.

**3.11.1.9** Bolt, nut and washer combinations as installed shall be taken from the same rotational-capacity lot.



**3.11.1.10** The Contractor shall supply a sufficient number of extra bolts, nuts, washers and DTIs for testing as may be required and described herein.

**3.11.1.11** Direct Tension Indicators shall conform to ASTM F 959, AASHTO 11.5.6.4.7.

**3.11.1.12** Spline end (twist-off) bolts and lock-pin and collar fasteners shall not be used.

### **3.11.2 Bolt Holes.**

**3.11.2.1** Holes for high strength bolts shall conform to the requirements of AASHTO 11.4.8.

**3.11.2.2 Primary members.** All holes in components of main members shall be subpunched and reamed, subdrilled and reamed, or drilled from the solid.

**3.11.2.3 Secondary members.** Holes in secondary members, including cross frames, diaphragms, and lateral bracing, may be punched full size when the thickness of the steel does not exceed the limits specified in AASHTO 11.4.8.1.1 [namely, 3/4" thick for structural carbon steel and 5/8" for high-strength steel].

**3.11.2.4 Lateral bracing.** Oversize holes (see [Table 550-5](#)) may be used for lateral bracing with the following provisions:

- (a) Oversize holes occur in only one component of the bolted connection.
- (b) The holes in the girder stiffener/connection plate are made standard size.
- (c) The locations of the oversize holes are indicated on the shop fabrication drawings.
- (d) The exposed oversize holes are covered with a hardened ASTM F 436 washer.

**3.11.2.5 Field reaming.** The field reaming of bolt holes is not permitted without approval of the Administrator, Bureau of Bridge Design, and shall conform to the requirements of [3.15.7](#).

**3.11.2.6 Welded restoration of material with misplaced holes.** The restoration by welding of material with misplaced holes shall be approved by the Engineer and shall be performed in accordance with [3.6.9](#) and the AASHTO Welding Specifications (section 3.7.7). Soundness of the restored base metal shall be verified by radiographic testing. For main members in tension, the weld repair shall be postheated at 200°F for one hour per 1" of plate thickness, and weld soundness shall be verified by ultrasonic or radiographic testing.

**3.11.3** Preassembly of bolted connections. Preassembly shall conform to the requirements of AASHTO 11.5.3.

**3.11.4 Match-marking.** Connecting parts assembled in the shop for the purpose of reaming or drilling holes in field connections shall be match-marked. A diagram showing the match marks shall be furnished to the Engineer, unless the connecting parts are shipped attached to the piece.

### **3.11.5 Bolted Parts.**

**3.11.5.1** All material within the grip of the bolt shall be steel. There shall be no compressible material such as gaskets or insulation within the grip. Bolted steel parts shall fit solidly together after the bolts are tightened. The slope of the surfaces of parts in contact with the bolt head or nut shall not exceed 1:20 with respect to a plane normal to the bolt axis.

**3.11.5.2** Prior to assembly, all joint surfaces, including surfaces adjacent to the bolt heads, nuts or washers shall be free of scale, and shall also be free of burrs, dirt, other foreign material, and other defects that would prevent solid seating of the connected parts in the snug tight condition.

**3.11.5.3** Contact surfaces within slip critical connections shall be free of oil, paint, lacquer, rust inhibitor, and galvanizing. Paint, including any inadvertent overspray, shall be excluded from areas closer than 1" from the edge of any hole and all areas within the bolt pattern, including under the bolt head and nut. Paint may be permitted on contact surfaces of slip critical joints, if approved by the Engineer, when the paint has been tested and the joints have been designed in accordance with AASHTO LRFD Bridge Design Specifications, Section 6.13.2.8.

**3.11.5.4** The length of bolts shall be such that the end of the bolt will be flush with or up to three threads outside the face of the nut when properly installed.

### **3.11.6 Installation and Tightening.**

#### **3.11.6.1 Handling and Storage of Fasteners.**

**3.11.6.1.1** Fasteners (i.e. threaded bolts and nuts), washers, and DTI's shall be protected from dirt and moisture at the job site and stored in a building, shed or trailer. Only as many fasteners as are anticipated to be installed and tightened during a work shift shall be taken from protected storage. Fasteners not used shall be returned to protected storage at the end of the shift. Storage in a shipping container covered with plastic sheeting is not acceptable.

## SECTION 550

**3.11.6.1.2** Fasteners shall not be cleaned of lubricant that is present in the as-delivered condition. Fasteners must be “oily” to the touch when installed. Galvanized nuts shall be checked to verify that a visible lubricant is on the threads. Lubricant shall be removed after bolt installation prior to painting.

**3.11.6.1.3** Weathered or rusted fasteners resulting from job site conditions shall be rejected. The Contractor may submit for approval a procedure for cleaning and relubricating rejected fasteners. Recleaned or relubricated bolt, nut and washer assemblies shall be retested in accordance with 3.11.1.8 prior to installation. Relubrication after cleaning may be accomplished with an approved stick wax applied to the bolt threads and to the nut face in contact with the washer.

**3.11.6.1.4** All fasteners shall be lubricated immediately prior to or during installation using an approved paraffin-based stick wax, as listed on the [Qualified Products List](#), applied to the bolt threads and to the nut face in contact with the washer. When the bolt head is the turned element apply the stick wax to the washer face in contact with the bolt head and to the bolt threads.

### 3.11.6.2 Bolt Tension.

**3.11.6.2.1** Fasteners (i.e. threaded bolts and nuts) together with washers of size and quality specified shall be installed in properly aligned holes and tensioned by the Direct Tension Indicator (DTI) method (or at the written request of the Contractor and with approval of the Engineer, the turn-of-nut method or calibrated-wrench method) to not less than the minimum tension specified in Table 550-6 when all the fasteners are tight. Bolts shall be tightened by turning the nut while the bolt is prevented from rotating. Tightening may be done by turning the bolt while the nut is prevented from rotating when it is impractical to turn the nut. Impact wrenches, if used, shall be of adequate capacity and sufficiently supplied with air to perform the required tightening of each bolt in approximately 10 seconds.

**Table 550-6 - Required Fastener Tension**

Nominal Bolt Size, inches	Minimum Bolt Installation Tension <sup>1</sup> in 1000's of pounds (kips)	5 % Greater Than Min. Bolt Tension <sup>2</sup> in kips
	A 325 Bolts	A 325 Bolts
1/2	12	12.6
5/8	19	20.0
3/4	28	29.4
7/8	39	41.0
1	51	53.6
1-1/8	56	58.8
1-1/4	71	74.6
1-3/8	85	89.3
1-1/2	103	108.2

<sup>1</sup> Equal to 70 percent of specified minimum tensile strength of bolts rounded to the nearest kip.

<sup>2</sup> Equal to 5 percent greater than minimum bolt installation tension rounded to the nearest 0.5 kip.

**3.11.6.2.2 Washers.** Each bolt shall have a hardened washer under the element (nut or bolt head) turned in tightening. Where an outer face of the bolted parts has a slope of more than 1:20 with respect to a plane normal to the bolt axis, a smooth beveled washer shall be used to compensate for the lack of parallelism.

### 3.11.6.3 Tension Calibrator.

**3.11.6.3.1** A tension calibrator device capable of indicating actual bolt tension, shall be supplied by the Contractor and shall be required at all job sites where high strength bolts in slip-critical connections are being installed and tightened.

**3.11.6.3.2** The bolt tension indicating device shall be used to confirm:

- (1) The suitability of the complete fastener assembly, including lubrication and thread condition, to be used in the work to satisfy the requirements of Table 550-6,
- (2) The calibration of the wrenches, if applicable, and
- (3) The understanding and proper use by the bolting crew of the method to be used.

**3.11.6.3.3** Confirmation tests shall be performed as specified in 3.11.6.4, 3.11.6.5 and 3.11.6.7, as applicable, to ensure that the as-installed bolt/nut/washer assembly meets installation requirements. The Engineer may require the recalibration of any wrench at any time.

**3.11.6.3.4** The Contractor shall deliver the bolt tension-indicating device to the Department's Laboratory before its use in the work to confirm its accuracy through calibration.

**3.11.6.3.5** Bolt/nut/washer assemblies used in calibration and confirmation tests shall not be used in the work. A sufficient number of bolt assemblies shall be supplied for testing.

**3.11.6.3.6** Calibration and confirmation testing shall use bolts with the same condition as those in the work at the time of final tightening. If final tightening is to occur after the bolted connection has been exposed to weather for a period of time, then bolts from the work shall be removed for testing.

#### **3.11.6.4 Turn-of-Nut Tightening.**

**3.11.6.4.1 Testing.** A representative sample of not less than three bolt/nut/washer assemblies of each diameter, length and grade to be used in the work, shall be checked at the start of each day's work in a device capable of indicating bolt tension. The test shall demonstrate that the method for estimating the snug-tight condition and controlling the turns from snug tight to be used by the bolting crew develops a tension not less than five percent greater than the minimum tension required by [Table 550-6](#).

**3.11.6.4.2 Snug tightening.** Bolts shall be installed in all holes of the connection and brought to a snug-tight condition. (If the joint is not properly "snugged", the tightening procedure will not work.) Snug tight is defined as the tightness that exists when the plies of the joint are in firm contact. This may be attained by a few impacts of an impact wrench or the full effort of a man using an ordinary spud wrench. Snug tightening shall progress systematically from the most rigid part of the connection to the free edges, and then the bolts of the connection shall be retightened in a similar systematic manner as necessary until all bolts are simultaneously snug tight and the connection is fully compacted.

**3.11.6.4.3 Tightening.** Following this initial snug tightening operation, all bolts in the connection shall be tightened further by the applicable amount of rotation specified in [Table 550-7](#). During the tightening operation there shall be no rotation of the part not turned by the wrench. Tightening shall progress systematically from the most rigid part of the joint to its free edges.

#### **3.11.6.5 Calibrated-Wrench Tightening.**

**3.11.6.5.1** The calibrated wrench method includes the use of manual torque wrenches which indicate torque by means of a dial and power wrenches which are adjusted to stall at a specified tension. Calibrated-wrench tightening may be used only when installation procedures are calibrated on a daily basis and when a hardened washer is used under the element turned in tightening. This specification does not recognize standard torques determined from tables or from formulas which are assumed to relate torque to tension. Installation torque must be determined directly from calibrations performed at the job site reflecting actual work conditions.

**3.11.6.5.2 Calibration.** When calibrated wrenches are used for installation, they shall be set to provide a tension not less than five percent in excess of the minimum tension specified in [Table 550-6](#). The installation procedures shall be calibrated by verification testing at least once each working day for each diameter, length and grade of bolt, using bolt/nut/washer assemblies that are being installed in the work. This verification testing shall be accomplished in a device capable of indicating actual bolt tension by tightening three typical bolts of each diameter, length and grade from the bolts being installed and with a hardened washer from the washers being used in the work under the element turned in tightening. Wrenches shall be recalibrated when a significant difference is noted in the surface condition of the bolts, threads, nuts, or washers.

**3.11.6.5.3 Snug tightening.** When calibrated wrenches are used to install and tension bolts in a connection, bolts shall be installed with hardened washers under the element turned in tightening bolts in all holes of the connection and brought to a snug-tight condition (see 3.11.6.4.2).

**3.11.6.5.4 Tightening.** Following the initial snug tightening operation, all bolts in the connection shall be tightened using the calibrated wrench to the minimum bolt installation tension in [Table 550-6](#). (Power wrenches shall be adjusted to stall or cut out at the required tension. Manual torque wrenches shall tighten the fastener to the torque value corresponding to the calibrated tension.) Tightening shall progress systematically from the most rigid part of the joint to its free edges. The wrench shall be returned to "touch up" previously tightened bolts which may have been relaxed as a result of the subsequent tightening of adjacent bolts until all bolts are tightened to the prescribed amount. If manual torque wrenches are used, nuts shall be turned in the tightening direction when torque value is measured.

**3.11.6.5.5 Verification.** Wrench adjustment shall be verified during actual installation in the assembled steelwork so that the wrench adjustment selected by the calibration does not produce a nut or bolt head rotation from snug tight greater than that permitted in [Table 550-7](#).

## SECTION 550

**3.11.6.6 Reuse of bolts.** ASTM A 325 bolts shall not be reused after having been tightened to the required fastener tension, Table 6. Touching up or retightening previously tightened bolts which may have been loosened by the tightening of adjacent bolts shall not be considered as reuse provided the snugging up continues from the initial position and does not require greater rotation, including the tolerance, than that required by Table 550-7. ASTM A 490 bolts shall not be reused.

**Table 550-7 - Nut Rotation from Snug Tight Condition<sup>1,2</sup>**

Disposition of Outer Face of Bolted Parts

Bolt Length <sup>4,5</sup>	BOTH FACES NORMAL to bolt axis	ONE FACE NORMAL to bolt axis and OTHER SLOPED not more than 1:20 (beveled washer not used)	BOTH FACES SLOPED not more than 1:20 from normal to the bolt axis (beveled washer not used)
Up to and including 4D (3.5")	1/3 turn	1/2 turn	2/3 turn
Over 4D to 8D (7")	1/2 turn	2/3 turn	5/6 turn
Over 8D to 12D <sup>3</sup> (10.5")	2/3 turn	5/6 turn	1 turn

<sup>1</sup> Nut rotation is relative to bolt regardless of the element (nut or bolt) being turned. For bolts installed by 1/2 turn (180 degrees) and less, the tolerance should be plus or minus 30 degrees; for bolts installed by 2/3 turn (240 degrees) and more, the tolerance should be plus or minus 45 degrees.

<sup>2</sup> Applicable only to connections in which all material within the grip of the bolt is steel.

<sup>3</sup> No research has been performed by the Council to establish the turn-of-nut procedure for bolt lengths exceeding 12 diameters. Therefore, the required rotation must be determined by actual test in a suitable tension measuring device which simulates conditions of solidly fitted steel.

<sup>4</sup> Bolt length is measured from underside of head to extreme end of bolt.

<sup>5</sup> Bolt lengths in parenthesis ( ) are for a 7/8" diameter bolt.

D = nominal bolt diameter (inches)

### 3.11.6.7 Direct Tension Indicator Tensioning.

**3.11.6.7.1 General.** These specifications are written to conform to Procedure for Verification and Installation of High Strength Bolts with Direct Tension Indicators (DTIs) in Appendix A6 of FHWA Report SA-91-031, revised April 1992, and AASHTO LRFD Bridge Design Specifications, except as noted. DTIs installed with high strength bolts to indicate bolt tension shall be subjected to field verification testing (3.11.6.7.2) prior to installation, and the installation requirements (3.11.6.7.3) described below.

**3.11.6.7.1.1** When Direct Tension Indicators (DTI's) are to be installed with high-strength bolts to indicate bolt tension, the DTI shall be placed under the head of the bolt with the protrusions facing the head of the bolt, and the nut shall be turned to tension the fastener with a hardened washer under it. If for reasons of installation or inspection accessibility it is necessary to place the DTI under the turned element, the DTI shall be oriented so that the protrusions face outward from the work, and a hardened washer shall be placed between the DTI and the turned element.

**3.11.6.7.1.2** The bolt, DTI, hardened washer, and nut assembly used in the verification testing device and installed in the work shall be such that at least 3 and preferably not more than 5 threads are located in the grip (i.e. between the bearing face of the nut and the bolt head).

**3.11.6.7.1.3** Bolts used in the verification test and those installed in the work shall not be tightened to a "no-visible" gap condition (i.e. a condition when all the DTI protrusions are completely compressed). A visible gap must remain in at least one space after installation. [It is possible to have no entries and yet have a visible gap. The load in the bolt becomes indeterminate when no gap exists and may exceed the capacity of the fastener, possibly causing bolt failure by tensioning beyond complete crushing of the DTI.]

**3.11.6.7.1.4** The Contractor shall supply 5 mil tapered feeler gages, a calibrated bolt tension-measuring device, and equipment necessary to perform field verification testing and inspection of tensioned bolts. The feeler gages, fasteners, and impact and manual wrenches shall be the same as that to be used in the work.

**3.11.6.7.1.5** It is mandatory that the Contractor obtain the services of a qualified technical advisor employed by the DTI manufacturer to make at least one site visit to assist the Contractor and to assure the proper installation and use of DTI's, unless the Contractor can demonstrate to the Department's satisfaction successful use of DTI's on previous projects for the Department.

**3.11.6.7.2 Field verification testing.** Verification testing shall be performed in a calibrated bolt tension-measuring device (Skidmore) with a special flat insert (supplied by the Contractor) replacing the normal bolt head-holding insert. (This special insert allows the DTI to be located on the flat front face of the Skidmore for ease of observation and greater access to measure the DTI gap during testing).

**3.11.6.7.2.1** The purpose of verification testing is to ensure that (i) the DTI's were properly manufactured (since it is the performance of the DTI that controls the installed bolt tension) and that the fastener in the work will be at or above the required installation tension when the DTI has been compressed to allow entries for fewer than half the number of spaces; and (ii) the fastener in the work will not plastically deform when the DTI is compressed to the maximum allowable limit for the project.

**3.11.6.7.2.2** Three verification tests are required for each combination of fastener rotational-capacity lot, DTI lot, and DTI position (under the nut or bolt head) used on the project. All three tests must pass for the DTI and assembly combination to be approved. Testing shall be performed at the jobsite by the Contractor and witnessed by the Department.

**3.11.6.7.2.3** When testing for the normal DTI position, the nut shall be turned and the bolt head against the DTI shall be restrained from turning with another wrench. When testing with the DTI under the turned element, the turned element shall be placed on the flat front face of the Skidmore and the unturned element will be in the rear held by another wrench.

**3.11.6.7.2.4** The verification test shall be conducted in two stages:

- a) **Stage 1.** The fastener shall first be tensioned to the Verification Tension load listed in [Table 550-8](#) for the grade and size of fastener. If an impact wrench is used, tension to a load two-thirds below the required load and use a manual wrench to attain the required tension. (The load-indicating needle of the bolt calibrator cannot be read accurately when an impact wrench is used, due to vibrations).
- b) Determine and record the number of entries of a 5 mil feeler gage in the spaces between the protrusions (the number of spaces on a DTI is listed in column 4 of [Table 550-8](#)). The number of entries shall meet the number listed in column 3 of [Table 550-8](#) under Verification - Required Number of Entries for the grade and size of bolt for DTI's. [When using coated (galvanized or epoxy coated) DTI's under the turned element there shall be at least one entry of the feeler gage.] The DTI lot is rejected if the number of entries is less than the value in column 3 of the table or if for coated DTI's used under the turned element there are no entries.
- c) **Stage 2.** After the number of entries is recorded at the verification load, the fastener shall be further tensioned with a manual wrench until there are no entries for the 5-mil feeler gage but a visible gap exists in at least one space. Note and record the load in the bolt at this condition (the maximum allowable limit of DTI compression) and remove the fastener from the tension-measuring device.
- d) The capability of the bolt to tolerate the maximum allowable limit of DTI compression is determined in two ways.
  - (i) The simplest is to hand turn the nut down the complete thread length of the bolt excluding thread runout. If this is successful, then the bolt has not undergone significant plastic deformation and the assembly passes the verification test.
  - (ii) If the nut cannot be turned down the complete thread length, the DTI lot shall be rejected unless the load recorded is less than 95% of the average load measured in the rotational capacity test of the fastener lot as specified in Article 11.5.6.4.2 of the AASHTO LRFD Bridge Construction Specifications, in which case the assembly is deemed to have passed the test.

**3.11.6.7.2.5** Bolts used in verification tests shall be marked and shall not be reused in the work.

**3.11.6.7.2.6 Short bolts.** If the bolt is too short to be tested in the calibration device, the DTI shall be tested on a longer bolt in a calibrator to determine the number of entries at the Verification Tension listed in column 2 of [Table 550-8](#). The number of entries shall meet the number listed in column 3 of [Table 550-8](#) under Verification - Required Number of Entries. Another DTI from the same lot shall then be assembled with the short bolt in a convenient hole in the work. The fastener assembly shall be tensioned with a manual wrench until there are no entries for the 5-mil feeler gage but a visible gap exists in at least one space. The fastener shall then be disassembled. Subsequently the nut must be run down, by hand, for the complete thread length of the bolt excluding thread runout. The DTI lot shall be rejected if the nut cannot be assembled to this thread length. Three verification tests are required as stated above.

**3.11.6.7.3 Installation and Inspection.** Installation of fasteners using DTI's shall be performed in two stages, initial (joint snugging) and final (bolt tensioning). For normal installation, the bolt head against the DTI shall be held against rotation during each stage of the installation while the nut is turned. Two workers are required, one to operate the wrench, and the other to prevent turning of the element against the DTI and to monitor the gap.

- a) **Stage 1 - Joint snugging.** The connection shall first be snugged with bolts installed in all the holes of the connection and the bolts initially tensioned sufficiently to bring all the plies of the connection into firm contact while the drift pins remain in the connection. Snugging shall progress systematically beginning at the most rigid part of the connection and progressing to the free edges until the connection is fully compacted, as described in 3.11.6.4.2.

**SECTION 550**

- b) DTI's shall be inspected after snugging and the gaps checked. The number of entries for a 5-mil feeler gage in the DTI after snugging shall meet the number listed in column 3 of [Table 550-8](#) under Verification - Required Number of Entries. If the number of entries is less than the values in the table, the fastener must be removed and another DTI installed, followed by resnugging of the fastener. [This is required because a fastener's tension may have relaxed during the snugging of adjacent fasteners. A compressed DTI does not rebound if the fastener tension is reduced. If a DTI were left in place, which has fewer entries, it would give a false indication of bolt tension.]
- c) **Stage 2 - Final bolt tensioning.** The bolts in the connection shall then be further tensioned to the point that the number of entries for a 5-mil feeler gage meets the number listed in [Table 550-8](#) under Installation - Required Number of Entries. Tightening shall progress systematically beginning at the most rigid part of the connection and progressing to the free edges. Drift pins shall be removed during this process. Several cycles may be required. If the fastener is tightened so that no visible gap in any space remains, the bolt and DTI shall be removed, and replaced by a new properly tightened fastener and DTI.
- d) An additional required inspection step is to check the bolt thread stickout on the nut side after installation to the final specified gap to look for inconsistency of pattern. Any stickouts greater than the other bolts shall be investigated and discarded (e.g. if necking down of the bolt has occurred or the wrong length bolt was used). The end of the properly installed bolt shall be at least flush with the nut or stick out not more than three threads.

**Table 550-8 - Direct Tension Indicators**

Bolt Size (inch)	Verification Tension <sup>1</sup> (kips)		Verification - Required Number of Entries <sup>2,3</sup>		Number of DTI Spaces between Protrusions		Installation - Required Number of Entries <sup>2,4</sup>	
	A325	A490	A325	A490	A325	A490	A325	A490
1/2	13	16	3-4	3-5	4	5	0-2	0-2
5/8	20	25	3-4	3-5	4	5	0-2	0-2
3/4	29	37	3-5	4-6	5	6	0-2	0-3
7/8	41	51	3-5	4-6	5	6	0-2	0-3
1	54	67	4-6	4-7	6	7	0-3	0-3
1-1/8	59	84	4-6	4-7	6	7	0-3	0-3
1-1/4	75	107	4-7	5-8	7	8	0-4	0-4
1-3/8	89	127	4-7	5-8	7	8	0-4	0-4
1-1/2	108	155	5-8	5-9	8	9	0-4	0-4

<sup>1</sup> Verification tension is 1.05 x the required [Table 550-6](#) installation tension.

<sup>2</sup> An entry occurs when a 5 mil tapered feeler gage fits into the space between DTI protrusions and touches the bolt shank. See 3.11.6.7.1.3.

<sup>3</sup> For coated DTI's under the turned element at least one entry is required.

<sup>4</sup> For coated DTI's under the turned element no entries are allowed.

**3.11.7.1 Inspection responsibility.** Before the installation of fasteners in the work, the Engineer shall check the marking, surface condition and storage of bolts, nuts and washers and the faying (contact) surfaces of joints for compliance with the above requirements. The Engineer shall observe calibration or testing procedures or both required above as applicable, to confirm that the selected procedure is properly used and that, when so used with the fastener assemblies supplied the tensions specified in [Table 550-6](#) are provided. The Engineer shall monitor the installation of fasteners in the work to assure that the selected procedure, as demonstrated in the initial testing to provide the specified tension, is routinely properly applied.

**3.11.7.2 Inspection of completed joints.** In addition to the requirements of 3.11.7.1, inspection of completed joints is required according to the following inspection procedure.

**3.11.7.2.1 Bolt tension for fasteners with DTIs** shall be verified by the use of a manual inspection torque wrench (which indicates torque by means of a dial) or by using 5 mil tapered feeler gages provided and operated by the Contractor.

**3.11.7.2.2 Calibration of inspecting wrench.** At least once each inspection day, a representative sample of three bolts of each diameter, length and grade of bolt used in the work shall be tightened in the tension measuring device by any convenient means to an initial (i.e. snug-tight) condition equal to approximately 15 percent of the required fastener tension and then to the minimum tension specified in [Table 550-6](#). There shall be a washer under the part turned in tightening each bolt. Tightening beyond the initial condition must not produce greater nut rotation than 1-1/2 times that permitted in [Table 550-7](#). The job-

inspecting torque shall be taken as the average of the torque required for all three bolts. The inspecting wrench shall then be applied to the tightened bolts in the work and the torque necessary to turn the nut or head 5 degrees (approximately 1" at 12" radius) in the tightening direction shall be determined.

**3.11.7.2.3 Inspection of turn-of-nut or calibrated-wrench tightened bolts.** Bolts represented by the sample in the foregoing paragraph which have been tightened in the structure shall be inspected by applying, in the tightening direction, the inspecting wrench and its job torque to 10 percent of the bolts, but not less than 2 bolts, selected at random in each connection in question. If no nut or bolt head is turned by application of the job inspecting torque, the connection shall be accepted as properly tightened. If any nut or bolt is turned by the application of the job inspecting torque, all bolts in the connection shall be tested, and all bolts whose nut or head is turned by the job inspecting torque shall be tightened and reinspected. Alternatively, it is the fabricator or erector's option to retighten all of the bolts in the connection and then resubmit the connection for the specified inspection.

**3.11.7.2.4 Inspection of DTI tensioned bolts.** All bolts installed using DTI's shall be inspected after snug tightening and again after full tensioning with 100% visual inspection and 10% of the bolts in any connection (but not less than two) shall be inspected by feeler gage. If the installation of inspected bolts is accepted, then the connection shall be accepted as properly tensioned. If any bolt in a connection does not pass inspection, then all (100%) of the bolts in that connection shall be inspected with the feeler gage. Any bolt which does not pass inspection, as described herein, shall be further tensioned, if required, or if over tensioned, shall be removed and replaced by a new properly tensioned bolt and DTI.

**3.11.7.2.5** This specification does not recognize standard torques determined from tables or from formulas which are assumed to relate torque to tension. Testing using such standard torques shall not be considered valid. Inspection torques must be determined directly from calibrations performed at the job site reflecting actual work conditions.

**3.11.7.3 Delayed verification inspection.** The procedure specified in 3.11.7.2 is intended for inspection of bolted connections and verification of pretension within 24 hours of tensioning the joint. If verification of bolt tension is required after a passage of a period of time and exposure of the completed joints, the procedures of 3.11.7.2 will provide an indication of bolt tension that is of questionable accuracy. Procedures appropriate to the specific situation should be used for verification of bolt tension. This might involve use of the inspection procedure contained in 3.11.7.2, or might require the development and use of alternate procedures.

## 3.12 Surface Preparation.

### 3.12.1 General Requirements.

**3.12.1.1 Scope.** All structural steel included in Section 550 shall be blast cleaned.

**3.12.1.2 Preblast.** Structural steel shall be blast cleaned prior to fabrication except as permitted in 3.12.3.

**3.12.1.3 Blast cleaning.** Blast cleaning shall be performed in conformance with the requirements of SSPC-SP 10, Near-White Blast Cleaning, unless otherwise directed.

**3.12.1.4 Method.** Blast cleaning shall be performed by either the centrifugal wheel or the air pressure blast method, unless permission is given to use other methods.

**3.12.2 Material condition.** Upon inspection of the cleaned steel, evidence of rolled-in scale or slag, pits, other surface imperfections, or laminations may indicate that certain material is unacceptable in accordance with ASTM A 6. The disposition of such unacceptable material shall be governed by 106.09. The welded repair of discontinuities shall be performed in conformance with the requirements of the AASHTO Welding Specifications and with 3.6.9. Welded repairs of main members in tension shall also be inspected by radiographic testing.

**3.12.3 Preparation for welding.** Mill scale shall be removed by blast cleaning from all structural steel surfaces to be welded. At the fabricator's option all mill scale may be removed from the faying (contact) surfaces by first grinding them to bare metal (e.g. girder flange-to-web and stiffener-to-web welds) before blast cleaning the rest of the steel. However, grinding is at the fabricator's own risk if subsequent blast cleaning reveals material conditions that are unacceptable.

### 3.12.4 Unpainted Weathering Steel.

**3.12.4.1 Initial cleaning.** High strength low alloy structural weathering steel shall be blast cleaned before fabrication to remove all mill scale or other foreign material in order to allow uniform oxidation to occur when exposed to the atmosphere. It will be necessary to remove all heavy coatings of oil or grease with suitable solvent prior to blast cleaning operations.

**3.12.4.2 Cleaning after fabrication.** Care shall be taken to keep weathering steel clean of all foreign matter such as grease, oil, chalk marks, crayon marks, and dirt during and after fabrication. Slag, flux, and spatter resulting from welding operations shall be removed. Identification markings on surfaces to be exposed to view in finished structures will not be permitted. Natural oxidation of the steel will not be considered foreign matter. Steel which becomes contaminated by foreign matter after it has been blast cleaned, shall be cleaned as soon as possible with the proper solvent according to the requirements of SSPC-SP 1, Solvent

## SECTION 550

Cleaning, or SSPC-SP 2, Hand Tool Cleaning, or SSPC-SP 3, Power Tool Cleaning, or SSPC-SP 10, Near-White Blast Cleaning depending upon the severity of the surface condition. Fascia girders will require cleaning by SSPC-SP 10, Near-White Blast Cleaning, if the above methods are not able to produce a uniform, acceptable surface on the fascia surfaces.

**3.12.4.3 Store to weather.** The cleaned high strength low alloy weathering steel shall be stored in a position and at a location allowing optimum weathering of the surfaces of the steel which will be exposed to public view. Water shall not be allowed to collect in puddles on such surfaces. The duration of exposure to the weather shall be as long as practicable prior to erection.

### 3.13 Shop Painting.

#### 3.13.1 General.

**3.13.1.1** Shop painting shall conform to the requirements of AASHTO “LRFD Bridge Construction Specifications” Section 13 and SSPC-PA 1 and the special provision, whichever provisions are more stringent.

**3.13.1.2** Structural steel conforming to AASHTO M 270 Gr 36 or 50 shall be painted, unless noted otherwise on the plans.

**3.13.1.3** Structural steel conforming to M 270 Gr 50W (weathering) shall not be painted, unless otherwise noted on the plans.

**3.13.1.4** Surfaces to be painted shall include bridge shoes (except sliding surfaces). Surfaces in direct contact with cast-in-place-concrete shall be painted with primer only.

**3.13.1.5** After paint has been applied, material shall not be handled until paint has thoroughly dried.

**3.13.1.6** See the special provision for paint sampling and testing requirements.

**3.13.2 Surface preparation.** Surface preparation for painting shall conform to the requirements of 3.12. If the steel surface after preblast and fabrication is not suitable for painting, it shall be blast cleaned again in accordance with SSPC-SP 10, Near-White Blast Cleaning.

#### 3.13.3 Paint System.

**3.13.3.1** When structural steel is required to be painted, the work shall conform to the painting requirements detailed in a special provision.

**3.13.4 Expansion joint.** When an expansion joint is included as part of the structural steel, it shall be painted with one shop coat of approved zinc-rich primer, to a minimum dry film thickness of 3 mils. Surfaces in direct contact with the seals shall be left unpainted. Surfaces in contact with concrete shall be primed only.

**3.13.5 Pier nose protection.** Pier nose protection steel (usually an angle) shall be galvanized in conformance with the requirements of AASHTO M 111 (ASTM A 123).

**3.13.6 Neutralizing welded surfaces.** Welded surfaces shall be neutralized by power wire brushing or blast cleaning prior to shop painting.

**3.13.7 Bearing protective coatings.** Machine finished surfaces in sliding contact, including surfaces in sockets at the top of rocker bearings, shall receive one coat of approved low temperature grease as soon as machining is complete. The Contractor shall maintain all protective coatings to prevent corrosion. All other machine finished surfaces shall be blasted and painted if painting of the structural steel is required.

### 3.14 Handling, Storing, and Shipping Material.

#### 3.14.1 General.

**3.14.1.1** Structural members shall be handled, stored and shipped in such a manner as to prevent damage to the material and to keep construction stresses within allowable values.

**3.14.1.2 Softeners.** Structural members shall be handled with suitable clamps or plate hooks which will not leave nicks, gouges, or depressions during handling. Chains shall not be used for handling structural members unless a protective shield (such as steel angles) is used between the chain and the steel.

**3.14.1.3** Girders and beams shall be handled, stored and shipped with their webs vertical and shall be adequately shored, braced, or clamped or braced and clamped to resist any lateral forces which might occur. Members other than girders shall be handled, stored and shipped at all times so that the stronger axis is vertical to resist the dead load of the member.

**3.14.1.4** Permanent distortion resulting from improper handling or storage will be cause for rejection.

#### 3.14.2 Handling.

**3.14.2.1** Shallow nicks, gouges, or dog marks 1/8” deep or less on structural material caused by lifting devices shall be repaired by grinding to produce a smooth, flared surface with a minimum 1:10 slope in the longitudinal direction. On main members, this ground repair area shall be nondestructively tested by the magnetic particle or dye penetrant method.



**3.14.2.2** Nicks and gouges deeper than 1/8" shall be repaired by filling with weld metal and grinding flush and smooth. The extent and method of repair of defects shall be consistent with the requirements for delivery of structural steel as specified in ASTM A 6. Welded repairs shall use a preheat of 250 °F and shall be inspected by ultrasonic and dye penetrant testing.

**3.14.2.3** Damage deformations outside of usual tolerances shall be reported to the Engineer. Kinks shall result in rejection of the member.

**3.14.2.4 Lifting.** Proper consideration shall be given to guard against lateral buckling when lifting beams and girders. Generally speaking, straight beams and girders 30" in depth or deeper, lifted according to the following criteria should be stable. Dimensions for length/width ratios are in feet and  $b$  equals the minimum width of the flange in compression.

- (a) One Crane (Overhang using a single line pickup at the girder centerline with or without a spreader) – For the unsupported overhang length,  $d$ , the maximum  $d/b$  ratio should not exceed 35 nor should the overhang length exceed 50 ft.
- (b) Two Cranes (Distance between beam clamps at the girder ends on a two-point pick-up) – For the unsupported length,  $a$ , between beam clamps on a two-point pickup, the  $a/b$  ratio should not exceed 85 nor should the distance between pickup points exceed 100 feet.

**3.14.2.5** Field connection holes shall not be used for lifting the material or for tie-down.

**3.14.2.6** Coated steel shall be insulated from lifting devices and from the scraping and rubbing of parts that would damage the coating by the use of lifting softeners, padded slings, storage pallets, separators, cushioners, tie-downs, and other approved supports.

### **3.14.3 Storage.**

**3.14.3.1** Structural material and fabricated members shall be stored at the fabrication shop or construction site above the ground on platforms, skids, blocking or other supports and shall be protected as far as practicable from surface deterioration by exposure to conditions producing rust. Material shall be kept free from accumulations of dirt, oil, and foreign matter and shall be positioned to permit proper drainage. See 106.07.

**3.14.3.2** Horizontally curved fabricated girders in storage shall be secured in an acceptable manner to prevent overturning.

### **3.14.4 Shipping.**

**3.14.4.1** Marking and shipping shall conform to the requirements of AASHTO 11.4.15.

**3.14.4.2** Shipping bolts shall be removed and discarded at the construction site and not incorporated in the final assembled structure.

**3.14.4.3** Structural material shall be clean and free from deformities upon arrival on the project.

**3.14.4.4** Hold-down softeners shall be used to prevent chain marks on the structural material during shipment. Such softeners shall be durable enough to perform adequately.

**3.14.4.5** Structural members shall be shipped in the upright position (with the webs vertical), unless there are unusual circumstances and written permission from the Administrator, Bureau of Bridge Design is obtained to do otherwise.

**3.14.4.6** Structural members shipped on truck beds or supported on dollies shall not cantilever behind same in excess of 25 percent of their length. Other shipping configurations shall require calculations that demonstrate that the member will not be overstressed during shipment and submitted for documentation in accordance with 105.02. The calculations shall account for impact by adding 200% to the calculated actual stress.

## **3.15 Erection of Structural Steel.**

### **3.15.1 Delivery and Field Inspection.**

**3.15.1.1** Material, workmanship, and condition after shipment will be inspected after delivery to the construction site, with this and any previous inspections constituting only partial acceptance.

**3.15.1.2** All work of handling, assembling and erecting structural steel shall be subject to the inspection and approval of the Engineer, who shall be furnished with necessary facilities, including scaffolding and supports, to provide access to the structure to allow for inspection of workmanship and testing of field connections.

### **3.15.2 Handling and Storage.**

**3.15.2.1** The provisions of 3.14 on handling and storage shall apply.

**3.15.2.2** No material shall, at any time, be dropped, thrown, dragged, or stored on the ground.

## SECTION 550

### 3.15.3 Falsework, Scaffolding and Erection Plans.

**3.15.3.1 Falsework and Scaffolding.** Falsework and scaffolding shall be properly designed and substantially constructed and maintained, without detrimental settlement or deformation, for the full loads that will come upon it. The Contractor shall prepare and submit plans for falsework and scaffolding for documentation in accordance with 105.02.

**3.15.3.2 Erection Plans.** Before starting the work of erecting all structures with welded girders or rolled beams, and prior to the erection of other structures when ordered, the Contractor shall submit an erection plan for documentation in accordance with 105.02. The erection plan shall describe the method of erection proposed and the amount and character of equipment proposed.

**3.15.3.3** The structural steel for the bridge may be used as supports for equipment and erection operations only when it is in its permanent position in the structure.

**3.15.4 Setting anchor rods.** Unless otherwise indicated on the plans, anchor rod holes having a diameter at least 1" larger than that of the anchor bolts shall be drilled normal to the plane of the bridge seat. Anchor rods shall be placed in the holes prior to final setting to assure proper fit. During freezing weather, the holes shall be kept free from ice in a satisfactory manner. Unless otherwise permitted, the final setting of anchor rods shall be made after all the structural steel has been erected.

**3.15.4.1** Anchor rods shall be set in one of the following materials:

- (a) Non-shrinking, non-ferrous, cement-base grout. This grout shall be used only when both the temperature of the masonry and the ambient temperature are kept at 40 °F or above until the grout has cured.
- (b) Fast-setting anchor cement.
- (c) Sulfur.

**3.15.4.2** Non-shrinking, non-ferrous, cement base grout or fast setting anchor cement shall be a product as included on the [Qualified Products List](#). Unless otherwise directed, the recommendations of the manufacturer of the product shall be followed exactly, so as to completely fill the space around the bolt.

**3.15.4.3** Anchor rods in expansion shoes shall be located in relation to the slotted holes as required by the prevailing temperature. The nuts on anchor rods at the expansion ends of spans shall permit the free movement of the span.

### 3.15.5 Setting Bearings.

**3.15.5.1** Bridge bearings shall be set level and must have full and uniform bearing on the substructure masonry. They shall not be placed on masonry bearing areas that are irregular or improperly cured or finished. Under no condition will the bearing area be acceptable at an elevation below that of the surrounding masonry.

**3.15.5.2** Unless otherwise indicated on the plans, bearing plates shall be placed on preformed fabric bearing pads meeting the requirements of 2.6. Each pad shall be the same size as the bearing plate it is to support. Holes for anchor rods shall be cleanly and accurately punched before setting the pad in place.

**3.15.5.3** Care shall be taken that full and free movement of the superstructure at the expansion bearings is not restricted by improper setting or adjustment of bearings or anchor rods and nuts.

**3.15.5.4** All protective grease applied in the shop to sliding bearing surfaces shall be removed immediately prior to erection of the superstructure. When the protective coating is removed, the parts shall be thoroughly cleaned and then recoated with the required grease (see 3.12.5.8) before erection of the superstructure.

**3.15.5.5** Shim plates, if required, shall be weathering steel or painted with shop-applied primer.

**3.15.5.6** Tightening anchor rods. Unless directed otherwise, use a lock washer directly under the nut and tighten bridge bearing anchor rods to a "snug condition", which is defined as the full effort of an iron worker using a wrench with a handle length equal to 14 times the diameter of the bolt (minimum 18"). All the anchor rods in a bearing shall be snugged in a star pattern, and then the pattern repeated a second time to check that no nuts have loosened.

### 3.15.6 Assembling Steel.

**3.15.6.1** Structural steel members shall be carefully handled during assembly so that no parts are bent, broken, or otherwise damaged. Slight defects may be repaired, if approved, and shall be corrected prior to erection. More severe damage and kinks will be cause for rejection of the damaged member. All repairs to structural steel shall be subject to approval by the Engineer.

**3.15.6.2** Structural steel shall not be erected before the bridge abutments have been backfilled to the elevation of the bridge seats, unless otherwise permitted. The final adjustment of bridge shoes shall be performed after approach slabs are constructed, unless otherwise permitted.

**3.15.6.3** The component parts of a structure shall be accurately assembled as shown on the plans and any match-marks shall be followed.

**3.15.6.4** Hammering which will injure or distort the members shall not be done.

**3.15.6.5** If surfaces which are to be connected by field bolting have been painted or contaminated with any foreign material or become moderately or heavily rusted that would make these connecting procedures unacceptable, the Contractor shall clean the surfaces of contaminants and loose rust at no additional cost to the Department. A tight coating of light rust will be permitted on faying (contact) surfaces of bolted joints.

**3.15.6.6** Fitting-up bolts shall be the required high strength bolts or bolts of the same nominal diameter as the high strength bolts. Cylindrical erection pins shall be 1/32" larger.

**3.15.6.7** Curved girders and long span straight girders shall be stabilized with falsework, temporary braces, or holding cranes until a sufficient number of adjacent girders are erected with all diaphragms and crossframes connected to provide the necessary lateral stability.

**3.15.6.8** Splices and field connections of main stress carrying members shall be made with a minimum of 50 percent of the holes filled with approved high strength bolts and full size erection pins before the external support systems are released. At least one-half of this percentage shall be bolts, tightened to specification requirements. The bolts and pins shall be installed uniformly throughout the connection except that erection pins shall be used in the extreme corners of all main connections.

**3.15.6.9** Members to be assembled on the ground before erection shall be blocked to their proper no-load profile and 100 percent of the approved high strength bolts shall be installed and tightened to specification requirements before erecting the member. The "no-load" profile is the fully cambered condition with no dead load deflections. When members are assembled with their webs vertical, they shall be supported at intervals of 20 ft., or two tenths of the span length, whichever is less.

**3.15.6.10** Diaphragms and crossframes shall be installed as the work progresses to ensure lateral stability of the members during all phases of the erection procedure.

**3.15.6.11** Between the first two lines of straight girders, each diaphragm or crossframe to girder connection shall be made with at least 50 percent of the holes filled with approved high strength bolts. The bolts shall be tightened until there is no gap between the connected parts. After the first two lines of girders are erected and stabilized, diaphragms or crossframes installed between subsequent lines of girders may have each of their connections made with a minimum of two approved high strength bolts installed in each connection unless a greater number of bolts is required for stability. The bolts shall be tightened until there is no gap between the connected parts.

**3.15.6.12** Between all lines of curved girders, each diaphragm or crossframe to girder connection shall be made with at least 50 percent of the holes filled with approved high strength bolts. The bolts shall be tightened until there is no gap between the connected parts.

**3.15.6.13** In bolted field splices, bolts shall be oriented so that the heads are visible to public view, unless directed otherwise. On fascia girders and beams, the bolt head shall be located on the outer web face. On all flanges, the bolt head shall be located on the bottom face.

### **3.15.7 Field Reaming and Drifting of Holes.**

**3.15.7.1** Members shall be subject to only light drifting to align holes. Any members subjected to drifting that results in distortion of the member or elongation of the holes will be rejected.

**3.15.7.2** No field reaming shall be performed on main member splice connections.

**3.15.7.3** Secondary members, i.e. diaphragms, crossframes, lateral bracing, etc., that have standard holes may be subjected to limited field reaming when approved by the Engineer. If approved, reaming shall not elongate holes by an amount greater than 1/16" for 75 percent of the holes in any erection sub-assembly and 1/8" for the remaining 25 percent. The following requirements shall also be met:

- (a) Reaming shall occur in only one component of the bolted connection.
- (b) Reaming shall only be done to the secondary member and not to connection or gusset plates welded to the main girder.
- (c) The reamed hole shall be covered with a hardened ASTM F 436 washer.

**3.15.7.4** Additional reaming of secondary members may be approved provided adequate edge distances and fastener spacing's are maintained. In such case, the next larger fastener size shall be used. The edge distance shall be considered to be that governed by the original fastener size for a rolled or planed edge.

**3.15.7.5** Field reaming producing results exceeding the limits previously described, will be cause for rejection of the member.

**3.15.7.6** Secondary members with oversize holes (see [Table 550-5](#)) shall not be field reamed without approval.

## SECTION 550

### 3.16 Field Welding.

**3.16.1 General.** Welding performed in the field on material that will become an integral part of the finished work or on any material used in a temporary capacity that will affect public safety shall be subject to all of the applicable requirements within this specification.

**3.16.2 Welder qualification.** Field welding shall only be performed by welders who have passed the qualification tests in conformance with the AASHTO Welding Specifications for the welding process and position, and material type and thickness required for the work. The minimum qualification shall be for “all-position” groove welding on “limited thickness” (3/4” maximum) plate. (The qualification test consists of vertical-up and overhead groove welds on 3/8” plate.) The welder must furnish acceptable proof of qualification, namely, AWS Certification or sworn copies of a satisfactory qualification test record or both. A welder’s qualification shall be considered as remaining in effect indefinitely unless the welder is not engaged in a given process of welding for which he is qualified for a period exceeding six months, or unless there is some specific reason to question the welder's ability.

**3.16.3 Process.** The shielded metal arc welding process (SMAW) is the only process approved for the field welding of structural steel. Welding shall only be done with low hydrogen electrodes (E 8018-C 3 with weathering steel or E 7018 with all other steels, unless approved otherwise).

**3.16.4 Approval.** Field welding of structural steel will not be permitted without approved drawings and welding procedures, unless approved otherwise.

**3.16.5 Weather conditions.** Welding shall not be performed when surfaces to be welded are wet from condensation, rain, snow or ice, when rain or snow is falling on the surfaces to be welded, or during periods of high wind unless the welder and the work are properly protected. Welding shall not be permitted when the temperature in the immediate vicinity of the welding is below 32 °F. (The environmental temperature may be below 32 °F but a heated structure or shelter around the area being welded shall maintain the temperature adjacent to the weldment at 32 °F or higher.)

**3.16.6 Surface preparation.** Surfaces to be welded and surfaces adjacent to the weld shall be free from loose or thick scale, slag, rust, moisture, grease, paint and other foreign material that would prevent proper welding. Surfaces shall be cleaned by blast cleaning or grinding to bare metal.

**3.16.7 Tack welds.** Tack welds are subject to the same quality requirements as the final weld, including preheat.

**3.16.8 Electrode storage and use.** Low hydrogen electrodes (E 7018) shall be kept until used in a portable holding oven heated and maintained at 250 °F. Once removed from the oven for use, the electrodes may not be exposed to the atmosphere for more than 4 hours or they must be discarded. Wet electrodes shall not be used.

**3.16.9 Preheat and interpass temperatures.** All base metal being welded shall be preheated to a minimum of 150 °F (max. 400 °F) within an area 3” minimum in all directions from the point of welding. This temperature must be maintained along the entire length of weld if more than one pass is required. Preheat temperatures shall be monitored with temperature indicating crayons.

**3.16.10 Clean up.** All weld slag shall be removed and the weld area suitably cleaned. Before painting, the weld area shall be power wire brushed or abrasively blast cleaned.

#### **3.16.11 Nondestructive Testing & Weld Repair.**

**3.16.11.1** Nondestructive testing of field welds shall be performed when so required by the plans, special provisions, specifications or the Engineer. Each test shall be witnessed by an authorized representative of the Department.

**3.16.11.2** Welds or sections of welds containing imperfections and judged unacceptable by the Department shall be removed and rewelded at the Contractor's expense. Welds so removed and replaced will be reinspected by the Department by the same method of inspection and judged by the same criteria, or the entire piece shall be rejected as determined by the Engineer.

**3.16.11.3** All costs for the reinspection of defective welds shall be at the Contractor's expense.

**3.16.11.4** The Contractor shall furnish and properly locate suitable scaffolding, platforms or other means of accessibility to the area where testing is required.

#### **3.16.12 Stud Welding.**

**3.16.12.1** Shear connectors used in composite beam construction shall be welded in place in accordance with the requirements of 547. Preheat shall not be required with the field use of automatically timed stud welding equipment, unless directed otherwise.

**3.16.12.2** Threaded fasteners (e.g. as stay-in-place form holddowns), if used, shall meet the requirements of [Section 547](#), and torque tested as per AASHTO Welding Specifications, Chapter 7.

### 3.17 Field Painting.

**3.17.1 General.** Field painting when called for on the plans shall include the proper preparation of the metal surfaces, the application, protection, and drying of the paint coatings, the protection of pedestrian, vehicular, or other traffic upon or beneath the bridge structure, and the protection of all portions of the structure against disfigurement. Surfaces other than those where paint has been permitted to remain shall be primed the same day that the steel is cleaned. In case cleaned surfaces are left overnight without priming, the steel shall be blast cleaned again and then cleaned in accordance with 3.12.4 before priming. See the special provision for paint sampling and application requirements.

**3.17.1.1** Existing dirt, dust and the debris from cleaning operations shall be removed from the roadway and structure to prevent the contamination of surfaces either prepared for paint or surfaces freshly painted. It may be necessary to remove or allay the dust on each end of the bridge to prevent traffic from picking it up. Repetitive operations will be required for the distance deemed necessary to assure protection for the paint surfaces.

**3.17.1.2** All necessary precautions shall be taken to prevent pollution and contamination of air and water during cleaning and painting operations. The precautions shall include, but not be limited to tarpaulins, plastic sheeting, plywood, and the like. The Contractor shall take prompt action to correct any noted deficiencies in methods. In populated areas, it may become necessary to control noise emissions from compressors.

**3.17.1.3** Care shall be taken to prevent damage to vegetation, water supplies, traffic, utilities, abutting properties, and the structure by equipment, personnel, and cleaning and painting operations. Any damage shall be promptly rectified. Any paint spattering shall be removed and the surfaces shall be repaired.

**3.17.1.4** Materials shall be stored in an area protected from traffic. Approved storage areas shall be secured by the Contractor.

**3.17.1.5** The Contractor shall furnish an approved dry film thickness gauge with which to measure the dry paint film.

**3.17.2 Cleaning.** When all field connections have been completed and approved and before applying the first field coat of paint, the surface of the shop coat shall be thoroughly cleaned of all loose or foreign substances. Oil and grease shall be removed by the use of SSPC-SP 1, Solvent Cleaning. All unpainted or damaged surfaces including all areas showing any evidence of the presence of rust, shall be blast cleaned as specified in SSPC-SP 10, Near-White Blast Cleaning, unless other effective means are permitted. The blast cleaned surface shall be painted the same day it is blast cleaned.

**3.17.3 Retouching.** After the steel has been cleaned, all surfaces not covered by the full thickness of shop coat paint, including areas from which the paint has been previously omitted, has been worn off or removed, or has become damaged, shall be thoroughly prepared and coated with the primer and intermediate coats of the specified paint system. See 3.13.3.

**3.17.4 Weather conditions.** During surface preparation, coating application and four hours thereafter, the ambient environmental and steel temperature shall be between 50° and 100 °F, the steel temperature shall be at least 5 °F above the dew point temperature, and the relative humidity shall not exceed 80 percent, unless manufacturer's recommendations state otherwise.

#### 3.17.5 Mixing and Thinning.

**3.17.5.1** All ingredients in any container of paint shall be thoroughly mixed before use and shall be agitated often enough during application to keep the paint in a uniform condition.

**3.17.5.2** All pigmented paint shall be strained after mixing except where application equipment is provided with adequate strainers. Strainers shall be of a type to remove only skins and undesirable matter but not to remove the pigment.

**3.17.5.3** If it is necessary in cool weather to have the paint of a thinner consistency than when delivered in the containers, the paint may be thinned to spread more freely by heating in hot water or on steam radiators. No thinner shall be added to the paint unless necessary for proper application. Paints to be applied by brush will usually require no thinning. Paints to be sprayed, if not specifically formulated for spraying, may require thinning when proper adjustment of the spray equipment and air pressure does not result in satisfactory paint application.

**3.17.5.4** The type of thinner shall comply with the paint specification or manufacturer's recommendations.

**3.17.5.5** When the use of thinner is permissible, thinner shall be added to paint during the mixing process. All thinning shall be done under the supervision of one acquainted with the correct amount and type of thinner to be added to the paint.

**3.17.6 Application.** Painting shall be done in a neat and workmanlike manner. Paint shall be applied with hand brushes or rollers, by spraying, or with permission, by other methods. By any method, the coating of paint applied shall be smoothly and uniformly spread so that no excess paint will collect at any point and the paint shall evidence no defects which detract from the system's performance.

**3.17.6.1** When brushes are used, the following provisions shall apply to both field coats: To secure a maximum thickness of paint film upon rivet and bolt heads and nuts (connectors), and upon edges of shapes, the edges shall first be striped with a

## SECTION 550

longitudinal motion and the connectors with a rotary motion of the brush. General painting of the whole surface, including the edges and connectors, may follow immediately.

**3.17.6.1.1** During general painting, the paint shall be so manipulated under the brush as to produce a smooth, uniform, even coating in close contact with the previously applied paint and the paint shall be worked into all corners and crevices.

**3.17.6.1.2** On all surfaces which are inaccessible to paint brushes, the paint shall be applied by spraying, with sheepskin daubers, or by other approved methods to ensure thorough covering.

**3.17.6.2** When spray equipment is used, the power equipment shall be capable of applying the paint in a fine, even spray. Connectors and edges of shapes shall be covered with preliminary passes of the spray gun or shall be striped by brushing as per 3.17.6.1. Care shall be exercised that adequate thickness of wet paint is deposited. When it becomes necessary to build the film thickness, the areas to be painted shall be sprayed horizontally and vertically, with ample overlapping. This may be repeated to gain film build. Areas inaccessible to the spray pattern shall be spot primed before spraying or shall be touched up by the use of brushes or the like after spraying.

**3.17.7 Field coats.** Field coats shall be applied as detailed in a special provision. All oil, grease, dirt, or salt deposited on the surfaces to be painted shall be removed before applying each successive coat of paint. Special recommendations of the manufacturer shall be followed exactly.

**3.17.7.1** Prior to painting, weld surfaces shall be power wire brushed or abrasively blast cleaned. Prior to painting, galvanized surfaces shall be pretreated with SSPC-SP1, Solvent Cleaning, using zinc phosphate or a light acid without attacking the zinc, to remove soluble contaminants, and abrasive blasting or other mechanical means to remove insoluble contaminants such as zinc hydroxide (i.e. white rust) and to thoroughly roughen the entire surface and produce a uniform anchor profile of 1 to 1.5 mils without removing the zinc layer. Alternate pretreatments or tie-coats may be considered if recommended by the coatings manufacturer and approved by the Department.

**3.17.7.2** Surfaces which have been galvanized or shop painted with an approved zinc rich paint and have become damaged after being coated shall be pretreated as specified in 3.17.7.1 and shall be repaired with 2 coats of approved zinc-rich primer. The second coat shall not be applied until the first coat has been approved.

**3.17.8 Paint thickness.** The total dry film thickness of the complete system (shop and field coats) shall be as specified in a special provision. The procedure to measure the dry film thickness shall be in accordance with SSPC-PA 2.

**3.17.9 Removal of paint.** If the painting is unsatisfactory, the paint shall be removed and the metal thoroughly cleaned and repainted.

### 3.18 Field Cleaning of Weathering Steel.

**3.18.1** All detrimental substances such as oil, dirt, grease, chalk and the like remaining after erection shall be removed as soon as possible. Concrete spatter shall be washed off immediately. To obtain a uniformly rusted appearance, the entire exterior fascia of the outside beams or girders shall be cleaned by means of brush-off blast cleaning in accordance with SSPC-SP 7.

### 3.19 Removal of Rust and Stains from Concrete.

**3.19.1** In the final stage of construction, all rust and other stains shall be removed from the exposed surfaces of the substructure, using approved methods as described in 534.3.2.3.

### 3.20 Fracture Control Plan.

**3.20.1 Specifications.** Fracture critical members shall conform to the following requirements and the AASHTO Welding Specifications, Chapter 12.

**3.20.2 Modifications to ASTM A 6.** The quality of steel plates shall meet the general requirements of Article 9, ASTM A 6, with the following modifications:

- (a) Mill conditioning and exploration will be limited to grinding or arc-air gouging. No welding at the mill is allowed.
- (b) The ground or gouged areas deeper than 1/16" shall not exceed 2% of the area of the surface being ground (conditioned).
- (c) After grinding, the net cross-sectional area shall not be less than 98% of the nominal cross-sectional area of the plate.
- (d) The thickness of the plate after removal of imperfections must not be reduced by more than 15% of the nominal thickness.
- (e) Weld repairs may be made in the fabrication shop in accordance with Section 550 and the AASHTO Welding Specifications.

**3.20.3 Additions to ASTM A 6.** The quality of steel plates shall meet the general requirements of Article 9, ASTM A 6, with the following additions:

- (1) Surface imperfections. All injurious surface imperfections shall be removed by the manufacturer of discrete cut length plates.

- a. Shallow imperfections shall be ground to sound metal; the ground area shall be well faired and the thickness of the ground plate shall not be reduced below the minimum thickness permitted.
- b. All surface imperfections, the removal of which will reduce the plate thickness below this minimum, shall be cause for rejection of the plate; however, by agreement with the purchaser, the metal so removed may be replaced with weld metal as provided in ASTM A 6 9.5.

**3.20.4 Qualification of fillet welds.** Prior to welding Fracture Critical Members the use of a 90 degree included angle shall be specified in qualification testing fillet-welding procedures, with the test plate welded in the position(s) of welding to be used in fabrication. The test weld shall be made with the same procedure and the same number of passes as will be used in production.

#### **Method of Measurement**

**4.1** Structural steel and bridge shoes will not be measured, but shall be the pound or Each, respectively, final pay quantities in accordance with [109.11](#) for structural steel and bridge shoes required as shown on the plans.

**4.1.1** Pier nose protection steel shall be included as part of the item of structural steel unless otherwise shown on the plans.

#### **Basis of Payment**

**5.1** Except as provided in [544.5.2](#), structural steel and bridge shoes are final pay quantity items and will be paid for at the Contract unit price per pound or each respectively complete in place in accordance with [109.11](#).

**5.1.1** The cost of inspection facilities, quality control inspection, tests, including equipment, supplies and technicians, to evaluate material, retests of unacceptable work, any necessary repairs, painting, and other items necessary for the proper completion of the work in accordance with the Contract shall be subsidiary.

#### **Pay items and units:**

550.1 _ _	Structural Steel (F)	Pound
550.2 _ _	Bridge Shoes (F)	Each

## SECTION 556

### *SECTION 556 -- PAINTING EXISTING STRUCTURAL STEEL*

#### **Description**

- 1.1 This work shall consist of field cleaning, and painting existing structural steel and bridge shoes that have been erected by others, using pollution control methods, as shown on the plans and specified in a special provision.
- 1.2 The location of the structures and the painting requirements will be described on the plans and in a special provision.

#### **Materials**

- 2.1 Paint shall conform to NEPCOAT Qualified Products List A or B, unless superseded by a Special Provision for Item 556-Painting Existing Structural Steel.

#### **Construction Requirements**

##### **3.1 Field Painting.**

- 3.1.1 **General.** Requirements for field painting shall be as specified in [550.3.17](#) and a Special Provision.

##### **3.2 Special Requirements.**

3.2.1 Loading and unloading of materials on the bridge will be permitted only with appropriate safeguards for traffic, such as construction signs and warning devices as required in the Manual on Uniform Traffic Control Devices (MUTCD), uniformed officers, and the like, and only at such times as may be permitted.

3.2.2 Temporary suspension of work may be required during periods when the traffic load is such that hazardous conditions would result from interference with the normal flow of traffic.

3.2.3 During field painting the Contractor shall provide appropriate safety measures, approved by the Department, for the protection of the public against damage due to paint drippings, paint spatter, windblown paint, falling objects, etc. The Contractor shall be fully responsible for property damage or personal injury which may result from operations incidental to the field painting of structural steel. The State shall be protected and indemnified in accordance with [Section 107](#).

3.2.4 The applicable portions of Sections [618](#) and [619](#) will apply to this item as though contained herein and will be subsidiary unless these items are included in the Contract.

3.2.5 Special signing requirements may be detailed in a special provision.

3.2.6 The paint system shall at all times during its application or repair be protected from dust, either caused by construction activities or by traffic, that may adhere to the uncured coating. When ordered the entire upper surface of concrete bridge seats shall be cleaned of all dirt and debris before beginning to paint the bridge shoes.

#### **Method of Measurement**

4.1 This item will be measured as a unit. When more than one unit is specified in the Contract, separate item numbers will appear for each separate and complete unit.

#### **Basis of Payment**

5.1 The accepted quantity of painted structural steel will be paid for at the Contract unit price.

Pay item and unit:

556.	Painting Existing Structural Steel	Unit
------	------------------------------------	------



**SECTION 559 – ASPHALTIC PLUG EXPANSION JOINT,  
ASPHALTIC PLUG CRACK CONTROL**

**Description**

**1.1** This work shall consist of all the work, including sawcutting and asphalt removal, as required to furnish and install a water tight asphaltic plug expansion joint and/or a water tight asphaltic plug for crack control, as shown on the plans. The asphaltic plug expansion joint and crack control is a commercial product and must be installed in accordance with the manufacturer's recommendations. When joint repair is specified, this work shall also include sawcutting, removal and disposal of the existing joint materials, as required to furnish and install a water tight asphaltic plug expansion joint and/or crack control, as shown on the plans.

**Materials**

**2.1** The asphaltic plug expansion joint shall be one of the products listed on the [Qualified Products List](#). The asphaltic materials (hot applied polymer modified asphaltic binder and aggregate) shall be applied by an applicator approved by the Manufacturer and shall meet the requirements of ASTM D6297. All components (except closed cell expansion material) of the asphaltic plug joint system shall be from one manufacturer.

**2.2 Asphaltic Plug Material.** The asphaltic plug material for crack control shall be one of the products listed on the [Qualified Products List](#). The asphaltic materials (hot applied polymer modified asphaltic binder and aggregate) shall be applied by an applicator approved by the Manufacturer and shall meet the requirements of ASTM D6297.

**2.3 Asphaltic Binder Material.** The asphaltic binder material for both expansion joint and crack control shall meet the polymeric modified asphaltic requirements of ASTM D6297.

**2.4 Steel Support Plate.** The steel support plate for the asphaltic plug expansion joint shall meet the requirements of ASTM D6297 or as recommended by the Manufacturer. The plate shall be galvanized as specified in [550.2.9](#), have a maximum length of 6 ft., and shall have pre-drilled holes at 12" on center for inserting the locating pins.

**2.5 Backer Rod.** The backer rod for the asphaltic plug expansion joint shall be a closed cell, high temperature, heat resistant material that meets the requirements of ASTM D5249.

**2.6 Closed Cell Expansion Material.** The closed expansion material used as a joint filler between the deck and approach slab or stub wall shall be a pre-formed, low-density, closed cell, cross-linked, EVA polyethylene co-polymer or polyethylene (XLPE) material that is flexible, waterproof, chemical resistant, and to be used as a compressible foam between concrete pours for full-depth protection. The product shall be resistant to abrasion, oxidation, oils, gasoline, salt and other materials that may come in contact with the surface. The material shall conform to ASTM D-1056, 2B2 and be a product as listed on the [Qualified Products List](#).

**2.6.1** The closed cell expansion material shall have the following physical properties per ASTM D3575:

Property	Test Method	Requirement
Water absorption	Suffix L	< 0.03 lb/ft <sup>2</sup>
Density	Suffix W	2.0 – 4.0 pcf
Compression Deflection	Suffix D	5 psi @ 25% min.
Elongation	Suffix G	200% min.
Tensile Strength	Suffix T	50 psi min.
Tear Strength	Suffix G	10 ply min.
Compression Set (@ 50% for 22 hrs)	ASTM D-1056 Suffix B	15% max. @ 24 hr. recovery

**2.6.2** The closed cell expansion material shall be furnished as detailed on the plans and shall be accepted based upon receipt of Certificate of Compliance stating that the product complies with the requirements of 2.6.1.

**Construction Requirements**

**3.1** The treatment of the deck, at grade approach slab, asphalt, and membrane waterproofing surface, and the preparation and installation of material shall be as recommended by the Manufacturer.

## SECTION 559

**3.2 Certificate of Compliance.** At least one week prior to the installation of the asphaltic plug expansion joint and/or crack control, the Engineer shall be provided with a certificate of compliance stating that all materials and equipment used for proper installation for the asphaltic joint complies with the requirements of this specification. All material delivered to the job site shall have a written certification that includes the following:

- 1) A label clearly showing the manufacturer's name, lot or batch number, date of manufacture, and date of packaging.
- 2) The date, if any, beyond which the material shall not be used without approval.
- 3) All the materials have been pre-tested and will meet the requirements of this specification.
- 4) The manufacturer's instruction for use and installation. All necessary equipment and manufacturer personnel as recommended shall be on site prior to beginning construction.
- 5) Certificate of analysis of the asphaltic plug material.

**3.3 Basis of Acceptance.** All materials and equipment shall be accepted upon certification by the qualified manufacturer, to the Engineer, that all the requirements of this specification have been met.

**3.4 Installation.** For each project, as recommended by the manufacturer, a trained, and certified technical representative with not less than 3 years of experience specializing in the installation of an asphaltic plug joint, shall be present during initial installations of the asphaltic plug expansion joint system to aid and instruct the Contractor as required to achieve an installation in accordance with the Manufacturer's requirements and specifications.

**3.4.1** For the asphaltic plug expansion joint, sawcut and completely remove the asphalt or existing asphaltic plug joint and membrane, down to the steel plate location as shown on the plans, to create a neatly formed blockout. The joint area shall be blast cleaned of debris and asphalt. The joint area shall be thoroughly dried using hot compressed air immediately prior to applying the asphaltic material. The blockout sides and base shall be inspected for defects and those noted shall be brought to the attention of the Engineer for direction regarding repairs of these areas. The sides of the blockout shall be vertical and clean with no loose material after inspection. The base shall be LEVEL between both sides of the bridge expansion gap. Proper leveling shall only be achieved by grinding or thin-set mortar. Mastic product or asphaltic binder material shall not be used under the support plates to create a level surface.

**3.4.2** For repair of an existing asphaltic plug joint, the existing plug joints shall be saw cut and removed to full depth in accordance with the plans or as ordered by the Engineer. Waterproof membrane materials, if present, shall be removed as required. If a steel plate is present, it shall be replaced with a new plate, as shown on the plans. Any concrete repair work required to provide a level surface between both sides of the expansion gap, shall be paid for in accordance with 109.04. All concrete, steel, and asphalt joint surfaces shall be prepared and treated as recommended by the Manufacturer's technical representative.

**3.4.3** For the asphaltic plug for crack control, sawcut and completely remove the asphalt and membrane or existing asphaltic material as shown on the plans, to create a neatly formed blockout. The bottom of the blockout shall be level with the top of the deck concrete. The blockout area above the deck concrete shall be free of asphalt, and the blockout area over approach roadway asphalt shall be blast cleaned to be free of loose asphalt debris. The joint area shall be thoroughly dried using hot compressed air immediately prior to applying the asphaltic material.

**3.4.4** The backer rod shall continue into the curb gap and be placed at a uniform depth following the geometry of the curb for placement and tooling of sealant as shown on the plans. The bridge asphaltic joint shall be completely cool before installation of the curb sealant over the backer rod.

**3.4.5** The asphaltic material shall be heated, mixed and placed in two (2) lifts using machinery and/or equipment supplied or recommended by the Manufacturer.

**3.4.6** Placement, screeding, and compaction of the asphaltic plug material shall be as recommended by the Manufacturer. Compaction shall be accomplished utilizing plate compactors or rollers.

**3.4.7** A skim coat of liquid asphaltic binder material shall be applied to fill any remaining surface voids.

**3.4.8** To prevent joint damage from tire traffic, shot blast media (clean, unused) shall be broadcast onto the finished joint surface while the asphaltic material is still warm.

**3.4.9** The application of the asphaltic binder and the asphaltic material shall be performed only if:

- 1) The surface temperature is at least of 40° F and rising,
- 2) The road surface is dry,
- 3) Weather conditions are favorable with no signs of imminent rain.

**3.4.10** Protect the joint from traffic until the material has cooled to 125° F± and is able to support traffic.

### 3.5 Warranty for Asphaltic Plug Expansion Joint.

**3.5.1 Limits of Warranted Work.** The warranted work includes all asphaltic expansion joint systems and installation within the project limits unless otherwise indicated in the proposal. This includes all necessary Maintenance of Traffic, all incidentals, and any uniformed traffic control personnel required to complete the warranted work. The Maintenance of Traffic shall be designed and implemented in accordance with the Contract requirements and with the latest edition of the Manual of Uniform Traffic Control Devices (MUTCD).

**3.5.2 Warranty Period.** The length of warranty will be three (3) years from the acceptance date of construction, as specified in the following sections of the specification and in compliance with 106.04 and 107.14.

**3.5.3 Warranty Parameters.** The following parameters shall be used to measure the performance of the asphaltic plug expansion joint system during the warranty period. Each condition parameter has a threshold limit (listed in Section 3.5.4) that defines when corrective action (warranty work) is required.

**3.5.3.1 Debonding.** A physical separation of the asphaltic expansion joint from the adjacent vertical face of the pavement or bridge deck.

**3.5.3.2 Transverse crack.** Any open crack that extends more in the transverse direction (perpendicular to traffic flow) than in the longitudinal direction.

**3.5.3.3 Longitudinal crack.** Any open crack that extends more in the longitudinal direction (parallel to traffic flow) than in the transverse direction.

**3.5.3.4 Leakage.** Visual seepage of water.

**3.5.3.5 Rutting.** Depression, displacement, or dislodgment of the asphaltic plug expansion joint surface.

**3.5.4 Warranty Requirements.** The following table lists the allowable threshold limit for each condition parameter for each asphaltic plug expansion joint. If any of the warranty thresholds are exceeded, corrective action (warranty work) is required.

**Asphaltic Plug Expansion Joint Warranty Requirements**

Condition Parameter	Threshold Limit for each Asphaltic Expansion Joint
Debonding (any edge)	5% total of the joint length, with no single debonded section greater than two (2) feet.
Transverse cracking	Sum length of all cracks > 5% total length of joint, with no single crack greater than two (2) feet.
Longitudinal cracking	sum length of all cracks > joint longitudinal dimension
Leakage	Visible seepage of water
Rutting	Maximum depth 1/2"

**3.5.4.1 Warranty Work (Corrective Action).** If any of the threshold limits for the asphaltic plug expansion joint are exceeded, the Contractor shall submit in writing the Manufacturer's corrective action plan to the Department for approval.

#### Method of Measurement

**4.1** Asphaltic plug expansion joint will not be measured, but shall be the linear foot final pay quantities in accordance with 109.11 as shown on the plans.

**4.2** Repair asphaltic plug expansion joint will not be measured, but shall be the linear foot final pay quantities in accordance with 109.11 as shown on the plans.

**4.3** Asphaltic plug for crack control will not be measured, but shall be the linear foot final pay quantities in accordance with 109.11 as shown on the plans.

## SECTION 559

### Basis of Payment

- 5.1. Asphaltic plug type expansion joint is final pay quantity item and will be paid at the contract unit price per linear foot complete in place in accordance with 109.11.
- 5.2. Repair asphaltic plug type expansion joint is final pay quantity item and will be paid at the contract unit price per linear foot complete in place in accordance with 109.11.
- 5.3. Asphaltic plug for crack control is a final pay quantity item and will be paid at the contract unit price per linear foot complete in place in accordance with 109.11.
- 5.4 The closed cell expansion material will be subsidiary to Item 559.4 Asphaltic Plug Expansion Joint.

**Pay item and unit:**

559.4	Asphaltic Plug Expansion Joint (F)	Linear Foot
559.41	Asphaltic Plug for Crack Control (F)	Linear Foot
559.412	Repair Asphaltic Plug Expansion Joint (F)	Linear Foot

**SECTION 560 -- PREFABRICATED COMPRESSION SEAL EXPANSION JOINT****Description**

- 1.1** This work shall consist of fabricating, furnishing and installing one of the following:
- (a) watertight prefabricated expansion joint utilizing a single preformed polychloroprene elastomeric (neoprene) compression seal,
  - (b) watertight prefabricated expansion joint utilizing a single preformed polychloroprene elastomeric compression seal with a prefabricated plow plates, in accordance with the contract plans, specifications, and the manufacturer's recommendations.

**Materials**

**2.1 Compression Seal.** The compression seal shall be polychloroprene elastomeric (neoprene) material conforming to AASHTO M297 (ASTM D3542) and meet the configuration shown on the plans and shall be a product as included on the [Qualified Products List](#). Each seal shall be furnished full length. Splices in the length of an individual seal will not be permitted unless the splices are made at the plant by the manufacturer of the seal with the approval of the Department. The seal material shall be identified with the production date, manufacturer's name or trademark, and lot number.

**2.2 Steel Members.** Steel members for prefabricated expansion joint and plow plates shall conform to specifications ASTM A 572 Grade 50. Minor steel plates and stop bars may conform to specifications ASTM A 36.

**2.2.1** Studs shall meet the requirements of AASHTO M 169 (ASTM A 108).

**2.2.2** All steel members shall be galvanized conforming to [550.2.9](#). If distortion becomes an issue, an approved zinc rich coating shall be used as approved by the Engineer.

**2.2.3** Anchorage of the compression seal expansion joint to the backwall and deck, between the curb lines, shall be made using a loop rebar attached to a joint support plate and shall be spaced at 1'-0" maximum, as shown on the plans. Brush curb and sidewalk anchorage shall be made of stud anchors and shall be spaced at 1'-6" maximum, as shown on the plans. The anchorage reinforcement shall extend into the backwall or curb reinforcement cage for proper anchorage.

**2.3 Lubricant Adhesive.** Lubricant adhesive shall be a one-part moisture curing polyurethane and aromatic hydrocarbon solvent mixture meeting the requirements of ASTM D4070 for use in lubricating preformed bridge seals for insertion and adhesion to metal and concrete surfaces.

**2.3.1** Each lot of adhesive shall be delivered in containers plainly marked with the manufacturer's name or trademark and shall be accompanied by the manufacturer's affidavit attesting conformance with the specification.

**2.4 Bolts for Plow Plates and Anchor Rods.**

**2.4.1** Bolts for the plow plates in roadway shall be 3/4" diameter high-strength hexhead bolts conforming to ASTM A325, galvanized.

**2.4.2** Anchor rods shall conform to ASTM 307, galvanized.

**Construction Requirements**

**3.1 General.** The expansion joint assembly shall be fabricated at an AISC certified plant with a certification in accordance to Section 550.3.2.

**3.2 Fabrication.**

**3.2.1 Submittals.** Shop fabrication drawings showing all details of the complete expansion joint assembly, such as dimensions, anchorage and welding procedures shall be submitted for approval in accordance with [105.02](#). Approval of the shop fabrication drawings shall be required prior to the manufacture of the assembly. Detailed welding procedures shall be considered an integral part of shop fabrication drawings and shall be submitted for approval along with the shop fabrication drawings. The shop fabrication drawings shall indicate the welding procedure to be used for each weld shown. The name of the manufacturer of the elastomeric compression seal shall be shown on the shop fabrication drawings. Original shop fabrication drawings, corrected, shall be delivered to the Department before the final payment is made.

**3.2.1.1** The manufacturer instructions for the proper installation of the joint system shall be shown on the shop drawings. Shop drawings that lack the manufacturer installation instruction, may be returned without approval.

**3.2.2** Fabrication and workmanship shall be performed in accordance with the applicable provisions of [550.3](#).

**3.2.3 Preblast.** All steel elements shall be blast cleaned before fabrication in conformance with the requirements of SSPC-SP 10, Near White Blast Cleaning. At the fabricators option, surfaces to be welded may be ground to bare metal. If the product is to be galvanized, blasting is not required before galvanizing.

## SECTION 560

**3.2.4** Welding of steel shall be performed in accordance with 550.3.6. Welding shall be performed by prequalified welders and welding operators.

### **3.2.5 Stud Welding.**

**3.2.5.1** Studs shall be welded using automatically-timed stud welding equipment in accordance with AASHTO Welding Specifications, Section 7 (see 550.3.6.10). Welding by SMAW is an option only if approved by the Department.

**3.2.5.2 Automatic equipment.** Studs shall be welded with automatically timed stud welding equipment connected to a suitable source of direct current straight polarity power. Welding voltage, current, time, and gun settings for lift and plunge should be set at optimum settings, based on past practice, recommendations of stud and equipment manufacturer, or both. AWS C5.4, Recommended Practices for Stud Welding, should also be used for technique guidance.

**3.2.5.3 Testing.** The first two welded studs installed and ten percent (10%) of the remaining studs shall be tested. The test shall consist of bending the studs, after they are allowed to cool, to an angle of approximately 15 degrees from their original axes by either striking the studs on the head with a hammer or placing a pipe or other suitable hollow device over the stud and manually or mechanically bending the stud. If any studs fail the test, then all studs shall be tested. Acceptable bent studs shall be left in the bent position.

**3.2.6** Shipping and adjusting devices required to ship, install, and adjust the joint assembly on the bridge shall be provided at approximately 4 ft. spacings and shall be furnished and installed by the fabricator.

**3.2.7** The joint system shall be fabricated by the manufacturer and delivered to the bridge site completely assembled, unless otherwise specified in the contract documents. The compression seal will be clearly identified for the corresponding joint location.

### **3.3 Inspection.**

**3.3.1 Notice.** The fabricator shall give ample notice (two weeks minimum) of the beginning of work so that arrangements can be made for inspection. No materials shall be fabricated before the Engineer has been so notified.

**3.3.2** The Department will inspect the fabrication of expansion joints. This inspection will include the examination of materials, welding, testing, work procedures, painting, and the final fabricated product.

**3.3.3** The Engineer may waive shop inspection and make a complete inspection at a later stage in the construction sequence.

**3.3.4** The Engineer shall visually inspect the seal material to confirm size, configuration, and identify possible defects in seal due to manufacturing or shipment. Any seal with defects shall be replaced at the Contractor's costs.

**3.3.5** When the materials are delivered to the job site, the manufacturer shall provide a certification to the Engineer that all materials meet the specification requirements.

**3.4 Installation.** The joint assembly shall be installed in the bridge as shown on the plans, in strict accordance with the manufacturer's written instructions along with the advice of their qualified representative.

**3.4.1** Class AA concrete shall be placed as blockout filler as directed.

**3.4.2** The joint system shall be set to line and grade and 1/8" lower, with vertical offset as detailed on the plans, ensuring that the system's uppermost plane parallels the finished roadway profile.

**3.4.3** In order for the expansion joint to be installed properly, it must be set at a width that is directly dependent upon the ambient temperature at the start of installation under the direction of the Engineer, as shown on the contract plans. The width setting shall be accomplished through the use of mechanical devices supplied by the fabricator.

**3.4.4** Cleaning the mating surfaces of the steel elements shall be performed just prior to installing the seal. The steel and seal surfaces shall be cleaned in accordance with the manufacturer's recommendations.

**3.4.5** Immediately after the joint has been secured to the structural steel and the abutment, the shipping and adjustment devices shall be removed and any bolt holes plug welded. Any welds on exposed surfaces shall be ground smooth. Repair any damaged galvanized surfaces according to 550.2.9.1.

**3.4.6** The compression seal shall be inserted into the joint with tools that will not damage the seal and will place the seal at the proper level in the joint. The seal shall be installed in the joint without stretching.

**3.4.7** The depth of setting the compression seal below the joint surface is critical to its performance. The seal shall be set in accordance to the depth indicated on the plans or per manufacturer's recommendation.

**3.5 Watertight Integrity Test.** At least five work days after the joint system has been fully installed, the Contractor shall test the entire (full length) joint system for watertight integrity employing a method satisfactory to the Engineer. The entire joint system shall be covered with water, either ponded or flowing, for a minimum duration of 15 minutes. The concrete surfaces under the joint

shall be inspected, during this 15 minute period and also for a minimum of 45 minutes after the supply of water has stopped, for any evidence of dripping water or moisture. Water tightness shall be interpreted to be no free dripping water on any surface on the underside of the joint. Patches of moisture shall not be cause for non-acceptance.

Should the joint system exhibit evidence of water leakage at any place whatsoever, the Contractor shall locate the place(s) of leakage and take all measures necessary to stop the leakage. The repair procedure shall be recommended by the manufacturer and approved by the Engineer. This work shall be done at the Contractor's expense. A subsequent water integrity test shall be performed subject to the same conditions and consequences as the original test.

#### Method of Measurement

**4.1** Prefabricated compression seal expansion joint will not be measured but shall be the linear foot final pay quantities in accordance with 109.11 for expansion joint required as shown on the plans.

**4.2** Prefabricated compression seal expansion joint with plow plates will not be measured but shall be the linear foot final pay quantities in accordance with 109.11 for expansion joints required as shown on the plans.

#### Basis of Payment

**5.1** Prefabricated compression seal expansion joint are final pay quantity items and will be paid for at the Contract unit price per linear foot complete in place in accordance with 109.11.

**5.2** Prefabricated compression seal expansion joint with plow plates are final pay quantity items and will be paid for at the Contract unit price per linear foot complete in place in accordance with 109.11.

#### Pay item and unit:

560.10XX	Prefabricated Compression Seal Expansion Joint (F)	Linear Foot
560.12XX	Prefabricated Compression Seal Expansion Joint w/Plow Plates (F)	Linear Foot
560.13XX	Prefabricated Compression Seal Expansion Joint – Rehabilitation (F)	Linear Foot

**SECTION 561 -- PREFABRICATED EXPANSION JOINT****Description**

**1.1** This work shall consist of fabricating, furnishing and installing a watertight prefabricated expansion joint system utilizing one of the following: (a) single preformed elastomeric strip seal with steel locking extrusions (edge rails), (b) single preformed elastomeric strip seal with steel locking extrusions (edge rails) and plow plates, (c) prefabricated finger joint, (d) modular bridge joint system (MBS) in accordance with the contract plans, specifications and the manufacturer's recommendations.

**Materials**

**2.1 Preformed Elastomeric Strip Seal Expansion Joint System.** The single preformed elastomeric strip seal joint systems with steel locking extrusions (edge rails) shall conform to the requirements of ASTM D5973, meet the configuration as shown on the plans, and be a product as included on the [Qualified Products List](#). Each seal shall be furnished full length. Splices in the length of an individual seal will not be permitted unless the splices are made at the plant by the manufacturer of the seal with the approval of the Department. The seal material shall be identified with the production date, manufacturer's name or trademark, and lot number.

**2.1.1 Steel members.** Steel members for the preformed elastomeric strip seal expansion joint system and plow plates shall conform to specifications ASTM A 572 Grade 50. Minor steel plates and extrusions may conform to specifications ASTM A 36.

**2.1.1.1** Studs shall meet the requirements of AASHTO M 169 (ASTM A 108).

**2.1.1.2** All steel members shall be galvanized conforming to [550.2.9](#) and [Section 708 - Appendix A](#), 3.2.3, 3.2.4 and 3.2.5. If distortion becomes an issue, an approved zinc rich coating shall be used as approved by the Engineer.

**2.1.1.3** Anchorage of the preformed elastomeric strip seal expansion joint to the backwall and deck, between the curb lines, shall be made using a loop rebar attached to a joint support plate and shall be spaced at 1'-0" maximum, as shown on the plans. Brush curb and sidewalk anchorage shall be made of stud anchors and shall be spaced at 1'-6" maximum, as shown on the plans. The anchorage reinforcement shall extend into the backwall or curb reinforcement cage for proper anchorage.

**2.1.2 Lubricant adhesive.** Lubricant adhesive shall be a one-part moisture curing polyurethane and aromatic hydrocarbon solvent mixture meeting the requirements of ASTM D4070 for use in lubricating preformed bridge seals for insertion and adhesion to metal and concrete surfaces.

**2.1.2.1** Each lot of adhesive shall be delivered in containers plainly marked with the manufacturer's name or trademark and shall be accompanied by the manufacturer's affidavit attesting conformance with the specification.

**2.1.3 Bolts for Plow Plates and Anchor Rods.**

**2.1.3.1** Bolts for the plow plates in roadway shall be 3/4" diameter high-strength hexhead bolts conforming to ASTM A325, galvanized.

**2.1.3.2** Anchor rods shall conform to ASTM 307, galvanized.

**2.2 Prefabricated Finger Joint System.** The prefabricated finger joint system shall meet the configuration and details as shown on the plans.

**2.2.1 Steel members.** Steel members for the prefabricated finger joint system shall conform to specifications ASTM A 572 Grade 50. Minor steel plates may conform to specifications ASTM A 36.

**2.2.1.1** Studs shall meet the requirements of AASHTO M 169 (ASTM A 108).

**2.2.1.2** All steel members shall be galvanized conforming to [550.2.9](#). If distortion becomes an issue, an approved zinc rich coating shall be used as approved by the Engineer.

**2.2.1.3** Anchorage of the prefabricated finger joint to the backwall and deck, between the curb lines, shall be made using a loop rebar attached to a joint support plate and shall be spaced at 1'-0" maximum, as shown on the plans. Brush curb and sidewalk anchorage shall be made of stud anchors and shall be spaced at 1'-6" maximum, as shown on the plans. The anchorage reinforcement shall extend into the backwall or curb reinforcement cage for proper anchorage.

**2.2.2 Fabric trough.** The preformed fabric trough shall be a product as included on the [Qualified Products List](#) and shall be a multi-layer sheet composed of multi-ply of 15 oz. per square yard (5%) polyester laminated with butadiene acrylonitrile and vulcanized to form an integral laminate, meeting the following requirements:



### Physical Properties

Number of Plies	3
Minimum Weight of Laminate (lbs/sq. ft.)	0.85
Minimum Thickness (inches)	5/32
Minimum Ultimate Tensile Strength of Laminate ((lbs/in) of width)	1,200
Maximum Elongation at Ultimate Tensile Strength	30%
Maximum Elongation at 1/10 Ultimate Tensile Strength	3%

#### 2.2.3 Bolts and Anchor Rods.

**2.2.3.1** Bolts in roadway plates shall be 3/4" diameter high-strength hexhead bolts conforming to ASTM A325, galvanized.

**2.2.3.2** Bolts in curb or sidewalk plates shall be 3/4" diameter countersunk head bolts with socket head and conforming to ASTM A276, Type 304 - stainless steel.

**2.2.3.3** Anchor rods shall conform to ASTM 307, galvanized.

**2.3 Modular Bridge Joint System (MBJS).** The modular bridge joint system shall be designed in accordance the current AASHTO LRFD Bridge Design Specifications, Article 14.5, " Bridge Joints", and meet the current AASHTO LRFD Bridge Construction Specifications, Section 19, " Bridge Deck Joint Seal". The MBJS shall be prequalified by satisfying all testing requirements detailed in the current AASHTO LRFD Bridge Construction Specifications, Appendix A19. MBJS shall meet the configuration as shown on the plans and shall be a product as included on the [Qualified Products List](#).

**2.3.1 Steel members.** Steel members for the modular bridge joint system shall conform to specifications ASTM A 572 Grade 50. Minor steel plates may conform to specifications ASTM A 36.

**2.3.1.1** Studs shall meet the requirements of AASHTO M 169 (ASTM A 108).

**2.3.1.2** All steel members shall be galvanized conforming to [550.2.9](#). If distortion becomes an issue, an approved zinc rich coating shall be used as approved by the Engineer.

**2.3.1.3** Anchorage of the modular bridge joint system to the backwall and deck, between the curb lines, shall be made using a loop rebar attached to a joint support plate and shall be spaced at 1'-0" maximum, as shown on the plans. Brush curb and sidewalk anchorage shall be made of stud anchors and shall be spaced at 1'-6" maximum, as shown on the plans. The anchorage reinforcement shall extend into the backwall or curb reinforcement cage for proper anchorage.

**2.3.2 Lubricant adhesive.** Lubricant adhesive shall be a one-part moisture curing polyurethane and aromatic hydrocarbon solvent mixture meeting the requirements of ASTM D4070 for use in lubricating preformed bridge seals for insertion and adhesion to metal and concrete surfaces.

**2.3.2.1** Each lot of adhesive shall be delivered in containers plainly marked with the manufacturer's name or trademark and shall be accompanied by the manufacturer's affidavit attesting conformance with the specification.

**2.3.3 Preformed elastomeric strip seal.** Preformed elastomeric strip seal joint system with steel locking extrusions (edge rails) shall conform to the requirements of ASTM D5973, meet the configuration as shown on the plans, and be a product as included on the [Qualified Products List](#). Each seal shall be furnished full length. Splices in the length of an individual seal will not be permitted unless the splices are made at the plant by the manufacturer of the seal with the approval of the Department. The seal material shall be identified with the production date, manufacturer's name or trademark, and lot number.

**2.3.4** Urethane foam shall conform to ASTM D3574.

**2.3.5** Polytetrafluorethylene (PTFE) shall be 100% Virgin Teflon, woven PTFE fabric, or dimpled PTFE conforming to the requirements of the current AASHTO LRFD Bridge Construction Specifications, Section 18.8 and shall be provided on every sliding surface.

**2.3.6** Stainless steel sheets shall conform to ASTM A240, Type 304, and shall be provided on every sliding surface. ASTM A240, Type 316 shall be used for a severe environment.

**2.3.7** Springs, bearings, and equidistance devices (control springs) shall be the same material composition and formulation, manufacturer, fabrication procedure, and configuration as the ones used in the prequalification test.

## SECTION 561

### Construction Requirements

**3.1 General.** The expansion joint assembly shall be fabricated at an AISC certified plant with a certification in accordance to Section 550.3.2.

**3.1.1** For a MBJS, the manufacturer shall have a minimum of three years' experience in designing and fabricating modular bridge expansion joint systems. The Contractor shall provide written certification of the manufacturer's experience.

### 3.2 Fabrication.

**3.2.1 Submittals.** Shop fabrication drawings showing all details of the complete expansion joint assembly such as dimensions, anchorages, and welding procedures shall be submitted for approval in accordance with 105.02. Approval of the shop fabrication drawings shall be required prior to the manufacture of the assembly. Detailed welding procedures shall be considered an integral part of shop fabrication drawings and shall be submitted for approval along with the shop fabrication drawings. The shop fabrication drawings shall indicate the welding procedure to be used for each weld shown. The name of the manufacturer of the preformed elastomeric strip seal shall be shown on the shop fabrication drawings. Original shop fabrication drawings, corrected, shall be delivered to the Department before the final payment is made.

**3.2.1.1** The manufacturer instructions for the proper installation of the joint system shall be shown on the shop drawings. Shop drawings that lack the manufacturer installation instruction, may be returned without approval.

**3.2.1.2** For modular bridge joint systems, the Contractor shall submit details of the MBJS to be used together with installation and waterproofing plans for approval in accordance with 105.02 prior to fabrication. The shop fabrication drawings shall be in accordance with 3.2.1 and the current AASHTO LRFD Bridge Construction Specifications, Section 19.

**3.2.1.3** For modular bridge joint systems, the Contractor shall submit test reports and certificates of the MBJS in accordance with the current AASHTO LRFD Bridge Construction Specifications, Section 19, for review and approval in accordance with 105.02 prior to fabrications. The Contractor shall also submit documentation of a Quality Assurance Inspection program performed by an independent inspection agency provided by the manufacturer. The name of the independent inspection agency, details of the proposed quality assurance inspection program including inspection frequency, and all applicable reporting forms shall be submitted prior to the start of fabrications.

**3.2.2** Fabrication and workmanship shall be performed in accordance with the applicable provisions of 550.3.

**3.2.3 Preblast.** All steel elements shall be blast cleaned before fabrication in conformance with the requirements of SSPC-SP 10, Near White Blast Cleaning. At the fabricators option, surfaces to be welded may be ground to bare metal. If the product is to be galvanized, blasting is not required before galvanizing.

**3.2.4** Welding of steel shall be performed in accordance with 550.3.6. Welding shall be performed by prequalified welders and welding operators.

### 3.2.5 Stud Welding.

**3.2.5.1** Studs shall be welded using automatically-timed stud welding equipment in accordance with AASHTO Welding Specifications, Section 7 (see 550.3.6.10). Welding by SMAW is an option only if approved by the Department.

**3.2.5.2 Automatic equipment.** Studs shall be welded with automatically timed stud welding equipment connected to a suitable source of direct current straight polarity power. Welding voltage, current, time, and gun settings for lift and plunge should be set at optimum settings, based on past practice, recommendations of stud and equipment manufacturer, or both. AWS C5.4, Recommended Practices for Stud Welding, should also be used for technique guidance.

**3.2.5.3 Testing.** The first two welded studs installed and ten percent (10%) of the remaining studs shall be tested. The test shall consist of bending the studs, after they are allowed to cool, to an angle of approximately 15 degrees from their original axes by either striking the studs on the head with a hammer or placing a pipe or other suitable hollow device over the stud and manually or mechanically bending the stud. If any studs fail the test, then all studs shall be tested. Acceptable bent studs shall be left in the bent position.

**3.2.6** Shipping and adjusting devices required to ship, install, and adjust the joint assembly on the bridge shall be provided at approximately 4 ft. spacing and shall be furnished and installed by the fabricator.

**3.2.7** The joint system shall be fabricated by the manufacturer and delivered to the bridge site completely assembled, unless otherwise specified in the contract documents. For single preformed elastomeric strip seal expansion joint systems, the preformed elastomeric strip seal will be shipped concurrent with the joint system and will be clearly identified as the joint location corresponding to the strip seal.

### 3.3 Inspection.

**3.3.1 Notice.** The fabricator shall give ample notice (two weeks minimum) of the beginning of work so that arrangements can be made for inspection. No materials shall be fabricated before the Engineer has been so notified.

**3.3.2** The Department will inspect the fabrication of expansion joints. This inspection will include the examination of materials, welding, testing, work procedures, painting, and the final fabricated product.

**3.3.3** The Engineer may waive shop inspection and make a complete inspection at a later stage in the construction sequence.

**3.3.4** The Engineer shall visually inspect the seal material to confirm size, configuration, and identify possible defects in seal due to manufacturing or shipment. Any seal with defects shall be replaced at the Contractor's costs.

**3.3.5** When the materials are delivered to the job site, the manufacturer shall provide a certification to the Engineer that all materials meet the specification requirements.

**3.3.6 Pre-installation inspection.** Immediately prior to installation, the Engineer shall inspect the MBS and the blockout for the following:

- a) Proper alignment.
- b) Complete bond between the seals and the steel.
- c) Proper placement and effectiveness of studs or other anchorage devices.
- d) The proper placement of waterproofing membranes shall be verified, if utilized.
- e) The clearance specified on the drawings (3.0" is recommended) between the bottoms of the support boxes of MBS and the surface of the blockout should be verified.
- f) Conformance with the current AASHTO LRFD Bridge Construction Specifications, Section 19.5.4.2.

**3.4 Installation.** The joint assembly shall be installed in the bridge as shown on the plans, in strict accordance with the manufacturer's written instructions along with the advice of their qualified representative. Installation of MBS shall also be installed in accordance with the current AASHTO LRFD Bridge Construction Specifications, Section 19.5.

**3.4.1** For the installation of MBS, a qualified installation technician shall be present at the job site to assure a proper installation of each expansion joint system. This technician shall be a full time employee of the manufacturer of the specific expansion joint system being installed. The Contractor shall comply with all recommendations made by the expansion joint manufacturer's installation technician as approved by the Engineer. Each expansion joint system manufacturer's installation technician shall certify to the Engineer that the Contractor properly followed the approved installation procedures. All certifications to the Engineer shall be in writing and shall be signed and dated by the manufacturer's installation technician.

**3.4.2** Class AA concrete shall be placed as blockout filler as directed.

**3.4.3** The joint system shall be set to line and grade, with vertical offset as detailed on the plans, ensuring that the system's uppermost plane parallels the finished roadway profile.

**3.4.4** In order for the expansion joint to be installed properly, it must be set at a width that is directly dependent upon the ambient temperature at the start of installation under the direction of the Engineer, as shown on the contract plans. The width setting shall be accomplished through the use of mechanical devices supplied by the fabricator.

**3.4.5** Cleaning the mating surfaces of the steel elements shall be performed just prior to installing the seal. The steel and seal surfaces shall be cleaned in accordance with the manufacturer's recommendations.

**3.4.6** Immediately after the joint has been secured to the structural steel and the abutment, the shipping and adjustment devices shall be removed and any bolt holes plug welded. Any welds on exposed surfaces shall be ground smooth. Repair any damaged galvanized surfaces according to [550.2.9.1](#).

**3.4.7** For a finger expansion joint system, a water collection and drainage system shall be located as shown on the plans. The drainage system shall catch and channel all water to a point where it can be discharged away from the superstructure and substructure.

**3.4.7.1** The hopper and downspout shall be secured to the concrete substructure at 10-foot intervals (maximum) or as shown on the plans or as directed by the Engineer.

**3.4.8 Watertight Integrity Test for the Strip Seal Expansion Joint System.** After the joint system has been fully installed, the Contractor shall test the entire (full length) joint system for watertight integrity employing a method satisfactory to the Engineer. The entire joint system shall be covered with water, either ponded or flowing, for a minimum duration of 15 minutes. The concrete surfaces under the joint shall be inspected, during this 15 minute period and also for a minimum of 45 minutes after the supply of water has stopped, for any evidence of dripping water or moisture. Water tightness shall be interpreted to be no free dripping water on any surface on the underside of the joint. Patches of moisture shall not be cause for non-acceptance.

## SECTION 561

Should the joint system exhibit evidence of water leakage at any place whatsoever, the Contractor shall locate the place(s) of leakage and take all measures necessary to stop the leakage. The repair procedure shall be recommended by the manufacturer and approved by the Engineer. This work shall be done at the Contractor's expense. A subsequent water integrity test shall be performed subject to the same conditions and consequences as the original test.

**3.4.9 Watertight Integrity Test for the Fabric Trough of the Finger Expansion Joint.** After the joint system has been fully installed, the Contractor shall test the entire length of the fabric trough for watertight integrity employing a method satisfactory to the Engineer. The entire joint system shall be covered with flowing water for a minimum duration of 15 minutes. The fabric trough, during this 15 minute period, shall be inspected for any evidence of dripping or splashing water. Water tightness shall be interpreted as all free dripping water is collected into the fabric trough and flows down the trough into the downspout. No free dripping water shall be outside the trough or splashing occurring at the entrance to the downspout.

Should the expansion joint exhibit evidence of water not being collected in the trough at any place whatsoever, the Contractor shall locate the problem place(s) and take all measures necessary to ensure that the fabric trough will collect all the water. The repair procedure shall be approved by the Engineer. This work shall be done at the Contractor's expense. A subsequent water integrity test shall be performed subject to the same conditions and consequences as the original test.

**3.4.10 Watertight Integrity Test for the MBJS.** After the joint system is installed and completed, the MBJS shall be flooded for a minimum of 1 hour to a minimum depth of 3.0", in accordance with the current AASHTO LRFD Bridge Construction Specifications, Section 19.5. For phase construction, the MBJS shall be flooded as noted above, for each completed phase. If leakage is observed, the MJBS shall be repaired to the Engineer's satisfaction and retested at the Contractor's expense. The repair procedure shall be recommended by the manufacturer and approved by the Engineer.

### Method of Measurement

**4.1** Prefabricated expansion joints, of the type specified, will not be measured, but shall be the linear foot final pay quantities in accordance with 109.11 for prefabricated expansion joints required as shown on the plans.

### Basis of Payment

**5.1** Prefabricated expansion joints, of the type specified, are final pay quantity items and will be paid for at the Contract unit price per linear foot complete in place in accordance with 109.11

#### Pay items and units:

561.10XX	Prefabricated Strip Seal Expansion Joint (F)	Linear Foot
561.12XX	Prefabricated Strip Seal Expansion Joint w/ Plow Plates (F)	Linear Foot
561.13XX	Prefabricated Strip Seal Expansion Joint Rehabilitation (F)	Linear Foot
561.20XX	Prefabricated Modular Bridge Joint System (F)	Linear Foot
561.23XX	Prefabricated Modular Bridge Joint System - Rehabilitation (F)	Linear Foot
561.30XX	Prefabricated Finger Expansion Joint (F)	Linear Foot
561.33XX	Prefabricated Finger Expansion Joint - Rehabilitation (F)	Linear Foot

**SECTION 562 -- SILICONE JOINT SEALANT****Description**

**1.1** This work shall consist of all work required to furnish and install silicone joint sealant as shown on the plans. The joint sealant shall consist of a cured-in-place silicone rubber material forming a flexible watertight seal.

**Materials**

**2.1** Silicone joint sealant shall meet the requirements of ASTM D 5893 and shall be a product listed on the [Qualified Products List](#). Silicone joint sealant for horizontal joints shall be either Type NS (Non-Sag) or Type SL (Self-Leveling). Silicone joint sealant for vertical joints shall be Type NS (Non-Sag).

**2.2** Backer rod, when required, shall be expanded closed cell polyethylene, meeting the requirements of ASTM 5249.

**2.3** Primer shall be a product recommended by the silicone joint sealer manufacturer.

**Construction Requirements**

**3.1 General.** The treatment of the steel, concrete, and stone surfaces and the preparation and installation of material shall be as recommended by the manufacturer.

**3.1.1** Concrete shall have cured a minimum of 14 days prior to application of the primer and/or sealant.

**3.1.2** The joint area shall be abrasive blast cleaned to achieve an anchor profile that is clean, and free of laitance, oil and foreign materials. Steel substrates shall receive an SSPC SP10 near-white metal blast cleaning or other treatment as directed by the Engineer prior to application of the primer. After blasting, all abrasives, dust and dirt shall be blown out of and away from the joint using a high-pressure air blast. All equipment used for preparing and cleaning the joint shall be equipped with traps capable of providing moisture-free and oil-free air. All surfaces shall be dry and frost-free.

**3.1.3** Primer shall be applied to all substrates to be sealed unless otherwise directed by the Engineer. The prime coat shall be applied in a thin, uniform layer over the entire contact surface area in accordance with the sealant manufacturer's recommendations.

**3.1.3.1** The primer shall cure in accordance with the manufacturer's recommendations before application of the sealant. In all cases, the prime coat shall be allowed to dry for a minimum period of 60 minutes prior to the application of the sealant. The priming operation shall not be performed more than 3 hours ahead of the sealing operation at any given time.

**3.1.4** The backer rod, when required, shall be installed at the appropriate distance below the finish grade surface. The width of the backer rod shall be approximately 25% wider than the joint opening.

**3.1.5** Silicone sealant installation method and application tools shall be as recommended by the manufacturer. Non-sag sealants shall be tooled in place in accordance with the manufacturer's recommendations.

**3.1.5.1** The silicone bead shall be no thicker than 1/2" and no thinner than 1/4". The top of the silicone bead shall be recessed 3/8" below finish grade except below paved surfaces, where sealant shall be at top of concrete. For non-joint applications on the plans where sealant is specified to fill a void, the sealant shall be pressed into place to completely seal the void and tooled to shed moisture.

**Method of Measurement**

**4.1** Silicone joint sealant will not be measured, but shall be the linear foot final pay quantities in accordance with [109.11](#) for silicone joint sealant required as shown on the plans. Material removed because of faulty workmanship will not be measured.

**Basis of Payment**

**5.1** Silicone joint sealant is a final pay quantity item and will be paid for at the Contract unit price per linear foot complete in place in accordance with [109.11](#). No additional payment will be made for the primer or backer material.

**Pay item and unit:**

562.1	Silicone Joint Sealant (F)	Linear Foot
-------	----------------------------	-------------

**SECTION 563 -- BRIDGE RAIL****Description**

**1.1** This work shall consist of furnishing and erecting bridge rail for bridges and retaining walls in conformity with details shown on the plans or ordered. This work shall include anchor rods or insert sleeves to support the railing and all construction above the top of the curb or sidewalk.

**1.2 Designations.** Bridge rails are classified as follows:

Type	Bridge Railing
Steel Tube Railing, 2 Rail	ST
Steel Tube Railing, 2 Rail (PL2)	T2
Steel Tube Railing, 3 Rail (PL2)	T3
Steel Tube Railing, 4 Rail (PL2)	T4
W-Beam with Steel Tubing	T101
Aluminum Railing (2 Bar)	F2
Aluminum Railing (3 Bar)	F3

**1.3** This work shall consist of furnishing and erecting protective screening or snow fence in conformity with details shown on the plans or ordered. Aluminum and steel components for screening may not be interchanged, and shall conform to the material requirements as detailed on the plans or as stated herein.

**Materials**

**2.1** Structural steel shall conform to the requirements of ASTM A572 Grade 50, unless otherwise specified on the plans, except anchor plates may be ASTM A36.

**2.1.1** Galvanized W-Beam sections shall comply with 606.2.4.

**2.2** Steel pipe shall conform to ASTM A 53, Grade B, seamless unless specified otherwise on the plans.

**2.3** Steel rail tubing shall conform to ASTM A 500, Grade B, unless otherwise specified on the plans. The tubing shall meet the Charpy V-notch toughness requirement of 15 ft-lbs at 0 °F. CVN test samples shall be taken after forming the tubes.

**2.3.1** For steel tubing rail-to-post fasteners shall be ASTM A 325 round-head bolts or ASTM A 276 Type 304 stainless steel threaded studs. All other fasteners may be ASTM A 307 bolts with ASTM A 563 nuts or cap screws. Anchor rods shall be ASTM A 449 with ASTM A 563 nuts.

**2.4** Galvanizing shall conform to AASHTO M 111 (ASTM A 123) for structural steel posts and tubing, AASHTO M 232 (ASTM A 153) for bolts, nuts, and washers, and conform to ASTM A 385 to provide adequate precautions (e.g. vent holes) for a quality product. The galvanizing kettle shall have 0.05 to 0.09 percent nickel. If the galvanizing is to be painted or powder coated, follow the requirements of Section 708, [Appendix A](#) or [B](#).

**2.5** The material requirements of [Section 606](#) shall apply for W-beam guardrail, thrie-beam guardrail, and tubular thrie-beam guardrail.

**2.6** Aluminum railing and aluminum and steel appurtenances shall conform to the pertinent materials specified in the latest edition of “A Guide To Standardized Highway Barrier Rail Hardware”, by the AASHTO-AGC-ARTBA Joint Cooperative Committee, ARTBA (formerly Technical Bulletin No. 268-B AGC Standard Form No. 131, June 1979) as amended.

**2.6.1** Stainless steel studs shall meet the requirements of ASTM A 276, Type 304 modified or Type 430 modified, each to 100,000 psi tensile strength with 15 percent elongation.

**2.7** Preformed bearing pads shall be manufactured as a single sheet approximately 1/8” thick, in the required dimensions shown on the plans. Bearing pads shall be accepted based upon receipt of a Certificate of Compliance stating that the products comply with the requirements of 2.7 (a) or (b), as applicable, including test results performed by an independent testing laboratory.

- (a) [M251 pads](#) - Plain or fabric-reinforced elastomeric pads conforming to AASHTO M 251 meeting the elastomer properties of 50 Shore A-durometer (minimum) material, adequate for 1,000 psi design compression stress, and meeting Level I test requirements with no cracks after the compressive load test, or
- (b) [Random-oriented fiber pads](#) consisting of a fabric and rubber body made with new unvulcanized rubber and unused fabric or synthetic fibers and vulcanized with a proportion of fiber content sufficient to maintain strength and stability. Rubber shall be polyisoprene (natural rubber) or polychloroprene (neoprene). The surface hardness shall be minimum  $80 \pm 5$

Shore A-durometer. The ultimate breakdown limit of the pad under compressive loading shall be no less than 7,000 psi without splits and without deformations exceeding 10 percent of thickness after removing the load.

**2.8** Protective screening and snow fence materials shall conform to the following:

**2.8.1** Aluminum components shall meet the material requirements of Standard No. BR-R12 (BR-R12 M) except as noted below.

**2.8.1.1** Aluminum chain link fabric shall be 6-gage 1 1/2" mesh conforming to AASHTO M181 Type III, ASTM B211 Alloy 6061-T94. Chain link fabric shall have a knuckled finish on the top and bottom.

**2.8.1.2** Aluminum tie material shall be 6-gauge conforming to ASTM B211 F626-96A. Wrap tie ends 1 1/2 times to attach all fabric to horizontal and vertical pipe rail. Tie bands shall not be allowed for attaching the fabric to the framework.

**2.8.2** Steel components shall meet the material requirements shown on the plans, except as noted below.

**2.8.2.1** Steel chain link fabric shall be 9-gauge 1 1/2" mesh conforming to AASHTO M181 Type II (aluminum coated steel). Chain link fabric shall have a knuckled finish on the top and bottom.

**2.8.2.2** Aluminum ties shall be used with aluminum coated steel fabric and conform to 2.8.1.2.

### Construction Requirements

**3.1 General.** Bridge rail shall be fabricated at a plant with an AISC Category SBR certification. See [550.3.2](#).

**3.2 Fabrication.**

**3.2.1** Shop fabrication drawings shall be submitted for approval in accordance with [105.02](#).

**3.2.1.1** The shop fabrication drawings shall show the lengths of all individual rail sections and locations of all field splices. Rail sections shall be supplied in continuous lengths as shown or specified on the plans. Butt welding of short pieces of rail to form the specified continuous length of rail section will not be permitted. Butt splices, if approved, shall be made in the shop with complete joint penetration (CJP) groove welds and inspected by ultrasonic testing.

**3.2.1.2** Horizontally-curved rail sections shall be shop bent to form a smooth curve, unless approved otherwise. It is required to secure the services of a specialty bend facility to do the work, as necessary, for small radii (eg. less than 50 feet). Curvatures with radii less than seven feet may be achieved by miter cut and welding the tube in chords lengths appropriate for the bend. A "miter-cut-and-weld" joint, where three sides of a tube are cut, the fourth side bent, and the cut edges welded with a backing bar, is considered to be a CJP. Curvature for T101 bridge rail tubes may be achieved with miter-cut-and-weld joints for radii less than 20 feet, if approved, since the tubes are hidden from view.

**3.2.2** Steel railings shall be constructed in accordance with the plans, the pertinent provisions of [550.3](#), or as directed.

**3.2.2.1** Welding of steel shall be done in accordance with [550.3.6](#). Welding shall be performed only by prequalified welders and welding operators.

**3.2.2.2** Threaded studs shall be welded on after the tubes are galvanized by spot grinding off the galvanizing, welding on the studs, and repairing the damaged galvanized coating as per [3.2.2.3](#).

**3.2.2.3** Damaged galvanized coating shall be repaired by cleaning, pretreating, and coating as specified in [550.2.9.1](#).

**3.2.2.4** Galvanized rail tubes, posts, and components shall be stored in a manner to prevent wet storage stain. Material shall be stored off the ground and individual elements separated with spacers to prevent contact between adjacent surfaces and to provide free and adequate circulation of air. Rail shall be inclined to provide continuous drainage and prevent ponding of water.

**3.2.2.4.1** Remove all 'white rust' (i.e. a build-up of zinc corrosion products- see [708-Appendix A](#)) from galvanized surfaces formed due to wet storage. Loose powders shall be removed with a stiff nylon bristle brush. Heavier accumulations of white rust shall be removed with a more vigorous treatment using brushing and approved solvents. Removing the white rust is essential to the proper formation over time of normal galvanizing (zinc carbonate) layers on the surface.

**3.2.3** Aluminum railing shall be constructed in accordance with the details shown on the plans.

**3.2.3.1** Welding of aluminum shall conform to [Section 716](#).

**3.2.3.2** All aluminum surfaces, including shims, to be placed in contact with concrete shall be given a heavy coat of asphalt-base aluminum roof coating.

**3.2.3.3** Aluminum shims in thicknesses of 1/16", 1/8", and 1/4" shall be furnished in sufficient quantities to permit adjustment of the rail alignment. The shims shall be the size of the bearing area and may be slotted for ease of installation. The shapes shall be shown on the shop drawings.

## SECTION 563

### Method of Measurement

4.1 Bridge rail, of the type specified, will be measured, but shall be the linear foot.

### Basis of Payment

5.1 Bridge rail, of the type specified will be paid for at the Contract unit price per linear foot complete in place.

5.2 All miscellaneous hardware needed to connect the protective screening or snow fence to the rail will not be paid for separately but will be considered subsidiary to the appropriate bridge rail item.

### Pay items and units:

563.12	Bridge Rail ST	Linear Foot
563.22	Bridge Rail T2	Linear Foot
563.221	Bridge Rail T2 with Protective Screening	Linear Foot
563.223	Bridge Rail T2 with Snow Screening	Linear Foot
563.23	Bridge Rail T3	Linear Foot
563.231	Bridge Rail T3 with Protective Screening	Linear Foot
563.24	Bridge Rail T4	Linear Foot
563.241	Bridge Rail T4 with Protective Screening	Linear Foot
563.243	Bridge Rail T4 with Snow Screening	Linear Foot
563.3	Bridge Rail T101	Linear Foot
563.72	Bridge Rail F (2-bar)	Linear Foot
563.721	Bridge Rail F (2-Bar) with Protective Screening	Linear Foot
563.723	Bridge Rail F (2-Bar) with Snow Screening	Linear Foot
563.73	Bridge Rail F (3-bar)	Linear Foot
563.731	Bridge Rail F (3-Bar) with Protective Screening	Linear Foot
563.733	Bridge Rail F (3-Bar) with Snow Screening	Linear Foot
563.8	Resetting Bridge Rail	Linear Foot
563.81	Rehabilitation of Bridge Rail	Linear Foot
563.84	Temporary Bridge Rail	Linear Foot
563.94	Protective Screening for Overpass Structures	Linear Foot



**SECTION 565 -- BRIDGE APPROACH RAIL****Description**

- 1.1 This work shall consist of the furnishing and erecting of bridge approach rail at the required location in conformity with the design shown on the plans or as ordered.
- 1.2 Designations will follow the classifications listed in 563.1.2.

**Materials**

- 2.1 Materials shall conform to 563.2.
- 2.2 The material requirements of [Section 606](#) shall apply for W-beam guardrail, thrie-beam guardrail, or tubular thrie-beam guardrail.

**Construction Requirements**

- 3.1 Fabrication and construction shall comply with the pertinent provisions of 563.3 and [606.3](#).

**Method of Measurement**

- 4.1 Bridge approach rail, of the type specified, will be measured by the unit.

**Basis of Payment**

- 5.1 Bridge approach rail, of the type specified will be paid for at the Contract unit price complete in place.

**Pay items and units**

565.12	Bridge Approach Rail, ST	Unit
565.22	Bridge Approach Rail, T2	Unit
565.23	Bridge Approach Rail T3	Unit
565.24	Bridge Approach Rail, T4	Unit
565.72	Bridge Approach Rail F, (2-bar)	Unit
565.73	Bridge Approach Rail F, (3-bar)	Unit
565.81	Rehabilitation of Bridge Approach Rail	Unit
565.XX2	Bridge Approach Rail " <u>Type</u> " (Steel Posts)	Unit

## SECTION 568

### ***SECTION 568 -- STRUCTURAL TIMBER***

#### **Description**

**1.1** This work shall consist of furnishing, fabricating, preparing, assembling, and erecting structural lumber and timber including the specified paint, preservative, metal parts, and hardware required in conformity with the details shown on the plans or ordered, excluding only those metal parts designated for payment under, or subsidiary to, another item.

#### **Materials**

**2.1** Structural lumber and timber shall consist of the species and grade shown on the plans or ordered, graded according to ASTM D 245.

**2.1.1** Round timber for framed bents and bearing piles shall conform to [510.2.1.1](#).

**2.2 Timber treatment.** Preservative materials, type and method of treatment, and minimum net retention of preservatives shall conform to the requirements of AASHTO M 133 or as shown on the plans.

**2.2.1** Wood to be painted after treatment shall be treated with a water-borne preservative.

**2.3** Structural shapes, including rods and plates, shall be of structural steel conforming to AASHTO M 183 (ASTM A 36).

**2.4** Castings shall be cast steel or gray iron, as specified.

**2.4.1** Steel castings shall conform to AASHTO M 192. Unless otherwise specified, all steel castings shall be Class 485.

**2.4.2** Gray iron castings shall conform to AASHTO M 105 (ASTM A 48). Unless otherwise specified, all gray iron castings shall be Class 30.

#### **2.5 Hardware.**

**2.5.1** Bolts and dowels shall be medium steel. Washers shall be ogee, gray or malleable iron castings, or shall be cut from medium steel.

**2.5.2** Machine bolts shall have square heads and nuts unless otherwise specified. Nails shall be cut or round wire of standard form. Spikes shall be cut spikes, wire spikes, or boat spikes, as specified.

**2.5.3** Unless otherwise specified, except for malleable iron connectors, all hardware, including nails, spikes, bolts, dowels, washers, and lag screws shall be galvanized in conformance with AASHTO M 232 (ASTM A 153) or cadmium plated in conformance with AASHTO M 299 (ASTM B 696).

**2.6** Paint when required shall be as specified and shall conform to [Section 708](#).

#### **Construction Requirements**

##### **3.1 Treatment and Inspection.**

**3.1.1** Framing and boring of treated timbers shall be done before the treatment is applied, except for such timbers subject to variations due to field conditions, as indicated on the plans or directed.

**3.1.2** The Contractor shall give ample notice to the Engineer of the beginning of the treatment at the plant so that inspection may be provided. The Contractor shall furnish all facilities for the inspection of material and its treatment. Inspection at the plant is intended as a means of facilitating the work and avoiding error, and it shall be understood that it will not relieve the Contractor of any responsibility in regard to any imperfect material or workmanship and the necessity for replacing the same. The acceptance of any material by the Engineer shall not be a bar to its subsequent rejection if found defective. Rejected materials shall be replaced promptly by the Contractor.

**3.1.3** All work of erection shall be subject to the approval of the Engineer, who shall be given all facilities required for a thorough inspection of workmanship. Material and workmanship not previously inspected will be inspected after it is delivered at the site of the work.

##### **3.2 Handling and Storage.**

**3.2.1** Loading, transporting, unloading, and piling of timber or lumber shall be conducted so that it is kept clean and free from injury.

**3.2.2** Lumber and timber shall be stored in piles at the site of the work. Untreated material shall be open-stacked and placed on skids so that it is at least 12" above the ground surface and piled so as to shed water and prevent warping. It shall be protected from the weather by suitable covering when directed. Treated material shall be close-stacked to prevent warping.

**3.2.3** All timber shall be carefully handled. Treated timber shall be so handled that there is no breaking of outer fibers or penetrating of the surfaces with tools. Treated timber shall be handled with rope slings without using cant hooks or similar appliances.

### **3.3 Workmanship.**

**3.3.1** All framing shall be true and exact. Nails and spikes shall be driven to set the heads flush with the surface of the wood unless otherwise directed. Hammer marks in wood surfaces will not be permitted. The workmanship on metal parts shall be as specified in 550.3.

**3.3.2** All lumber and timber shall be accurately cut and framed for a close fit with joints bearing evenly over the entire contact surfaces. Mortises shall be true size for their full depths with tenons fitted snugly. Shimming of joints will not be permitted and open joints will not be accepted.

### **3.4 Piles.**

**3.4.1** Construction requirements for piles shall conform to the pertinent provisions of 510.3 and the following:

**3.4.2** The piles in any bent shall be selected so that they are of uniform size.

**3.4.3** When a pile is driven out of line, it shall be straightened or replaced before being cut off or braced. Injured piles will not be accepted. Shimming on tops of piles and undue distortion of bracing will not be permitted.

**3.4.4** After cutting to receive the caps and before the caps are placed, pile heads shall be treated as follows:

**3.4.4.1** The sawed surfaces of treated pile heads shall be covered with 3 applications of an approved preservative meeting the requirements of 2.2.

**3.4.4.2** The sawed surfaces of untreated pile heads shall be thoroughly brush coated with 2 applications of an approved preservative meeting the requirements of 2.2.

**3.4.5** After being treated as specified above, all pile heads shall be covered with sheet metal of the kind specified on the plans. The edges shall be bent down over the sides of the pile and neatly trimmed.

### **3.5 Framed Bents.**

**3.5.1** Mud sills shall be firmly and evenly bedded to solid bearing and tamped into place.

**3.5.2** Sills, posts, and caps shall have true and even bearings on their supports.

**3.5.3** Superstructure stringers shall be sized at bearings and placed so that knots in their edges shall be in the top portions. The joints of stringers, two panels in length, shall be staggered unless otherwise permitted.

**3.5.4** Cross-bridging between stringers shall be as shown or ordered.

**3.5.5** Wheel guards and railings shall be constructed to true line and grade. They shall be placed in sections not less than 12 ft. in length unless otherwise shown or permitted.

**3.5.6** Trusses shall show no irregularities of line when completed. Chords shall be straight and true from end to end in horizontal projection. They shall show a smooth curve through panel joints conforming to the required camber in vertical projection.

### **3.6 Connections.**

**3.6.1** Connections shall be of the types shown or ordered.

### **3.7 Painting.**

**3.7.1** Rails, rail posts, and other portions of the timber work shown or ordered to be painted shall be given three coats of approved paint. Metal parts, except hardware, shall be given one coat of approved shop paint before erection and two coats of approved field paint after erection.

## SECTION 568

### Method of Measurement

4.1 Structural timber will not be measured, but shall be the thousand foot board measure (MBM) final pay quantity in accordance with 109.11 for structural timber required as shown on the plans.

### Basis of Payment

5.1 Structural timber is a final pay quantity item and will be paid for at the Contract unit price per MBM complete in place in accordance with 109.11.

5.2 When a quantity for metal parts other than hardware is included in the proposal, such metal parts will be paid for as provided on the plans.

5.3 Bearing piles will be paid for under Section 510.

### Pay item and unit:

568.

Structural Timber (F)

MBM

**SECTION 570 -- STONE MASONRY****Description**

**1.1** This work shall consist of furnishing all materials and constructing masonry of approved stones, laid with or without cement mortar, as shown on the plans or ordered.

**Materials**

**2.1** Stone shall be furnished in accordance with Table 570-1.

**Table 570-1 - Stone for Stone Masonry**

Stone	Source	Quality	Dress and Cut	Finish	
				Top and Bottom	Vertical Face Joints
Ashlar	approved quarry having the required quantity	compact, hard and practically non-absorbent; texture and color as indicated on plans or ordered	to exact dimensions	fine	fine
Squared	approved quarry having the required quantity	compact, hard and practically non-absorbent; texture and color as indicated on plans or ordered	roughly squared and to approximate dimensions	rough for at least 12" depth	rough for at least 9" depth
Rubble	field, quarry, or rock excavation	approved, sound, clean, and free from structural defects	unsquared, roughly dressed	---	---

**2.1.1 Ashlar and Squared Stone.**

**2.1.1.1** Stones shall have their edges pitched to a true line with tops and bottoms parallel and cut to lie on their natural beds. The bottom beds shall be the full size of the stone, and hollow beds or overhanging tops will not be permitted.

**2.1.1.2** When specified as random or broken-ranged, stone shall have vertical joints unless otherwise indicated on the plans.

**2.1.1.3** Size of stone shall be as indicated on the plans.

**2.1.1.4** Surface finish shall be as shown on the plans in accordance with the following schedule:

- (a) Smooth finished: surfaces in which the variations from the pitch line do not exceed 1/16"
- (b) Fine finished: surfaces in which the variations from the pitch line do not exceed 1/4"
- (c) Rough finished: surfaces in which the variations from the pitch line do not exceed 1/2"
- (d) Scabbled: surfaces in which the variations from the pitch line do not exceed 3/4"
- (e) Rock-faced: surfaces on which there are no tool marks and which have irregular projection beyond the pitch line of not more than 1-1/4"
- (f) Weather-faced: surfaces which have been exposed to the weather for sufficient time to become weather beaten in appearance
- (g) Seam-faced: surfaces which are formed by seams in the natural ledge before stone is quarried

**2.1.1.5** All stone shall be so finished that no holes or portions of holes will show on surfaces which will be exposed in the finished work.

**2.2** Cement mortar shall conform to [Section 707](#).

**2.3** Stone masonry anchors shall be of the shapes and dimensions shown on the plans. The minimum ultimate tensile strength shall be 42,000 psi. Anchors shall be zinc-coated (galvanized) in accordance with ASTM A 653, coating designation G 90.

**Construction Requirements****3.1 Classification.**

**3.1.1** Stone masonry shall be classified by pattern: ranged, broken ranged, or random.

## SECTION 570

- (a) Ranged masonry shall be laid up in regular courses of uniform height throughout their entire lengths. When the height of courses is varied, it shall be regularly diminished from bottom to top masonry.
- (b) Broken-ranged masonry shall be laid up with courses not continuous throughout their entire lengths.
- (c) Random masonry shall be laid up without courses.

3.1.2 Stone masonry shall be classified by type of stone and thickness of joints, in accordance with Table 570-2.

### 3.2 Laying Stone.

3.2.1 All shaping and dressing of stone shall be done before it is placed.

3.2.2 When required, the Contractor shall submit details of falsework or centering for approval.

3.2.3 No stone in broken-ranged or random work shall be laid in a structure until at least 50 percent of the amount required for the structure has been delivered at the site.

3.2.4 Stone shall be carefully set without jarring stone already laid and shall be handled with a lewis or other suitable device which will not mar the stone. Rolling or turning of stone on masonry already in place will not be permitted.

**Table 570-2 - Stone Masonry Classification**

<b>Class of Masonry</b>	<b>Type of Stone</b>	<b>Joint Material</b>	<b>Max. Thickness</b>
Ashlar	Ashlar	Cement mortar	1/2
Mortar Squared Stone	Squared	Cement mortar	1
Dry Squared Stone	Squared	Dry (closely and lightly pinned)	----
Mortar Rubble	Rubble	Cement mortar	1-1/2
Dry Rubble	Rubble	Dry (closely and lightly pinned)	----
Copings	Squared (Sawn Finish)	Cement mortar	1/2

3.2.5 Stone to be laid in cement mortar shall be thoroughly cleaned before being set, and the bed to receive it shall be well cleaned. The thickness of all joints and beds shall be uniform throughout. Spalls shall not be used as panners in mortar beds or joints. When any stone is disturbed or mortar joint broken, the stone shall be taken up, and after all mortar has been cleaned from the stone, bed, and joints, it shall be reset in fresh mortar.

3.2.6 All stones shall be well bedded with the face joints properly pointed before the mortar has set, unless otherwise permitted. When permitted, joints to be pointed after mortar has set shall be raked out to a depth of 2" before mortar has set and when pointed, shall be moistened and filled with mortar well driven in. All pointing shall be finished with an approved pointing tool to form the type of joint indicated on the plans or ordered.

3.2.7 The masonry shall be kept wet during the pointing and in hot or dry weather shall be protected from the sun and kept wet for a period of 3 days after completion unless otherwise permitted or ordered. The exposed surfaces of the stones shall not be smeared with mortar. The joints shall be wiped free of loose mortar. Stone shall not be set when containing frost or during freezing weather unless permitted. When permission is granted, the masonry shall be protected in the same manner as concrete in 520.3.7 except that liquid curing compound shall not be used, and the masonry temperature shall be controlled as provided in 520.3.7.4.7.

### 3.3 Bond.

3.3.1 Stretchers shall have a depth of bed of not less than 1-1/2 times their height. They shall have a length not less than their height, nor less than 3 ft., nor more than 3-1/2 times their height, unless otherwise indicated on the plans.

3.3.2 Headers shall have a length of 1-1/2 times their height and shall extend entirely through masonry having a thickness of 4 ft. or less. In masonry having a thickness greater than 4 ft., the depth of headers shall not be less than 2-1/2 times their height when the course is 18" or less in height, and not less than 4 ft. in courses of greater height. Headers shall hold into the heart of the wall the same size shown on the face, bonding not less than 12" with the core or backing. Headers shall be placed over stretchers equally dividing the spaces between headers of adjoining courses with no joints coming immediately over or under headers. Headers shall be spaced not more than 8 ft. apart, and there shall be at least 1 header to every 2 stretchers unless otherwise indicated on the plans.

3.4 **Copings.** Stone for copings shall be selected. Copings shall be as shown on the plans.

3.5 **Cores and backing.** Cores or backing shall be of stone or concrete masonry as indicated on the plans.

**3.5.1** Stone backing shall be laid as specified for face stone, with headers interlocking with face headers when the thickness of the masonry permits. Stone in backing or cores shall break joints with the face stone and bond not less than 12" with the face stone and with each other. Stone backing or cores shall be carried up with face stone and at least 50 percent of the stone shall be of the same size and character as the face stone and shall have parallel ends. When stone is laid in cement mortar, the beds shall be full and shall not exceed 1" in thickness, and the joints shall be completely filled and shall not exceed 4" in thickness.

**3.5.2** Concrete backing or cores shall be of the class shown on the plans and as specified in 520. The concrete shall be so worked and compacted that all spaces around stones are completely filled and an adequate bond with the stone is secured. Construction joints in the concrete, required by intermittent placing, shall be located not less than 6" below the top bed of any course of the stone facing. The concrete shall be so placed that the stone masonry facing is not disturbed.

**3.6 Metal dowels and cramps.** Dowels and cramps shall be of the material, size, and shape, and at the locations indicated on the plans or as ordered. Holes for dowels or cramps shall be drilled in the stones before they are placed unless otherwise permitted. Cramps shall be countersunk flush with the top of the stone in which they are set. This work shall be subsidiary.

**3.7 Culvert headwalls and retaining walls.** In addition to applicable construction requirements, unless otherwise specified on the plans or in the special provisions, culvert headwalls and retaining walls to be constructed of mortar rubble masonry or dry rubble masonry shall conform to the following requirements: At least 75 percent of the stone shall be larger than 6 by 9 by 12" No dressing, finishing, or coursing will be required. The stone shall be set without disturbing stone already in place. Stone to be laid in mortar shall be clean and moist and shall be placed on a full mortar bed. The stones shall be bonded in a workmanlike manner.

**3.8 Weepers.** Unless otherwise indicated on the plans, the Contractor shall furnish and place 4" weepers in all closed abutments and retaining walls. These weepers shall be approximately 10 ft. apart and placed at the elevation which will best drain backfill. French drains of stone or coarse gravel shall be placed adjacent to the fill face of such walls and at such elevations as will permit drainage to and outletting into the weepers.

### **3.9 Stone Masonry Arches.**

**3.9.1** Masonry for rings shall be ashlar or mortar squared stone unless otherwise indicated on the plans. Voussoirs shall be full size and shall have a bond of not less than the depth of the stones. Their beds shall be dressed to bring them to radial planes and to permit them to rest properly on the centering. The inside faces of stone backing or spandrel walls and extrados shall be given a finishing coat of 1:2-1/2 cement mortar troweled smooth, and waterproofed as indicated on the plans.

**3.9.2** Masonry in arch rings shall be placed in such a manner as to load the ring uniformly about the center or as indicated on the plans.

#### **Method of Measurement**

**4.1** Stone masonry, of the class specified, except coping and resetting masonry wall will not be measured, but shall be the cubic yard final pay quantity in accordance with 109.11 for stone masonry required as shown on the plans.

**4.2** Stone coping will not be measured, but shall be the linear foot final pay quantity in accordance with 109.11 for stone coping required as shown on the plans.

**4.3** Resetting masonry wall will be measured by the cubic yard, to the nearest 0.1 of a cubic yard.

#### **Basis of Payment**

**5.1** Stone masonry, of the class specified, except coping and resetting masonry wall, are final pay quantity items and will be paid for at the Contract unit price per cubic yard complete in place in accordance with 109.11, with the exception that masonry steps including the parapet walls will be paid for at 1.5 times the Contract unit price per cubic yard for the class specified.

**5.2** Stone coping is a final pay quantity item and will be paid for at the Contract unit price per linear foot complete in place in accordance with 109.11.

**5.3** The accepted quantity of resetting masonry wall will be paid for at the Contract unit price per cubic yard complete in place.

#### **Pay items and units:**

570.1	Ashlar Masonry (F)	Cubic Yard
570.2	Mortar Squared Stone Masonry (F)	Cubic Yard
570.3	Dry Squared Stone Masonry (F)	Cubic Yard
570.4	Mortar Rubble Masonry (F)	Cubic Yard
570.5	Dry Rubble Masonry (F)	Cubic Yard
570.6	Stone Coping (F)	Linear Foot
570.9	Resetting Masonry Wall	Cubic Yard

## SECTION 572

### *SECTION 572 – STONE WALL*

#### **Description**

1.1 This work shall consist of reconstructing stone walls where shown on the plans or as ordered.

#### **Materials**

2.1 Stone from the existing stone wall shall be utilized to reconstruct the wall at the specified location.

2.1.1 Any special stone features such as lintels, gate posts, copings, markers, etc. shall be retained for resetting.

2.2 Any added stone shall conform to the type used in the original wall.

2.3 Gravel for surface preparation shall meet the requirements of [Section 209](#).

#### **Construction Requirements**

3.1 The reconstructed stone wall shall match the existing wall as closely as possible.

3.1.1 The Contractor shall, by photographs and measurements acceptable to the Engineer, record the width, height and configuration of the existing wall prior to removal. These photographs and measurements along with the prevailing width, height and configuration shall be used to guide the reconstruction of the wall. These records shall be made at intervals of not more than 500 ft. and at locations where characteristics of the wall change. The photographs shall become the property of the Department at the end of the project.

3.1.2 When existing wall sections designated for reconstruction are in such disrepair that the original wall configuration cannot be determined, these sections shall be rebuilt to match abutting wall segments.

3.2 The stone wall reconstruction shall be supervised by a person with experience in dry masonry construction.

3.3 Care shall be taken to keep weathered faces exposed.

3.4 The Contractor shall retain all stone from existing wall for reuse. Additional stones that may be necessary shall be blended with the existing stones in order to reproduce the appearance of the existing wall.

3.5 The Contractor shall carefully replace chinking, blocking, bond stones and headers, as appropriate to the original style of wall, to ensure the maximum stability of the wall.

3.6 The Contractor shall carefully duplicate special features of the original wall, such as lintels, gate posts, openings, copings, markers, etc.

3.7 The ground surface shall be prepared by removing brush, vegetation, topsoil and unsuitable material. The area shall be rough graded to obtain a reasonably firm and level surface.

#### **Method of Measurement**

4.1 Reconstructing stone walls will be measured by the linear foot, to the nearest 1 foot, along the center line of the reconstructed wall.

4.2 Clearing and grubbing will be measured as provided in [Section 201](#).

4.3 Gravel required for surface preparation will be measured by the cubic yard, complete in place. Limits of gravel will be as shown on the plans, or as ordered.

#### **Basis of Payment**

5.1 The accepted quantity of reconstructed wall will be paid for at the Contract unit price per linear foot complete in place.

5.1.1 Any additional stone required to complete the reconstruction will be subsidiary.

5.1.2 Reconstruction of special features as defined in 3.6 will be subsidiary.

5.1.3 Photographs and measurement records of the existing wall will be subsidiary.

5.2 Ground surface preparation will be subsidiary.

5.2.1 When special site preparation such as clearing and grubbing or gravel base courses are ordered, this work will be paid under appropriate items of the Contract. If appropriate items are not included in the Contract, this work will be paid as provided in [109.04](#).



**Pay items and units:**

572.1	Reconstructing Stone Wall, One Stone Wide	Linear Foot
572.2	Reconstructing Stone Wall, Multiple Stones Wide	Linear Foot
572.3	Reconstructing Stone Wall, Double Faced with Loose Fill	Linear Foot

**FOR INFORMATION  
GENERAL CONFIGURATION OF STONE WALLS**

---

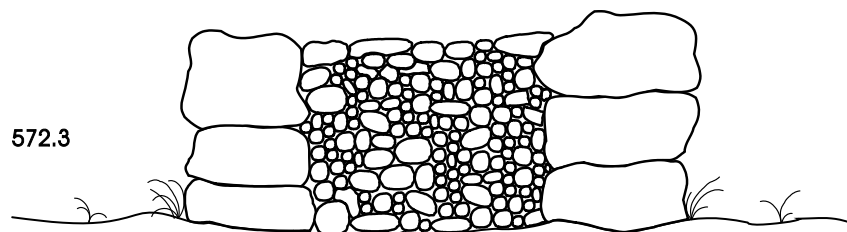
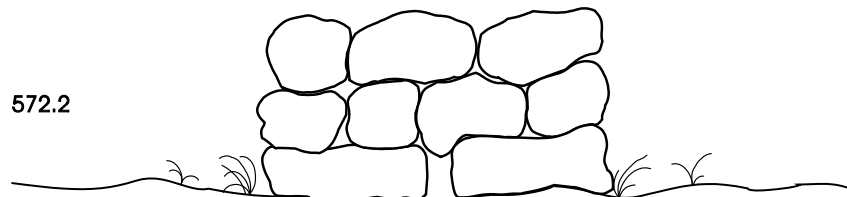
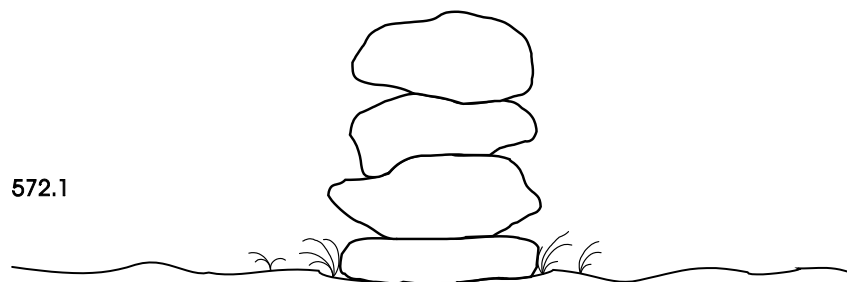

**NOTE:** DEPICTIONS ARE FOR DESCRIPTION OF THE ITEMS AND NOT INTENDED TO BE USED FOR CONSTRUCTION DETAIL.

**SECTION 582 -- SLOPE PAVING****Description**

1.1 This work shall consist of a paved area of concrete as specified constructed at the locations shown on the plans or as ordered.

**Materials**

2.1 Concrete shall be Class A and conform to [Section 520](#). The slump shall be 2 to 3”.

2.2 Welded wire fabric shall conform to AASHTO M 55 (ASTM A 185) with a minimum gauge and spacing to be as shown in accordance with the Concrete Reinforcing Steel Institute.

2.3 Granular backfill shall conform to [209.2.1.2](#).

2.4 Preformed Joint filler shall conform to AASHTO M 213.

**Construction Requirements**

3.1 The Contractor shall set forms so that the concrete slabs as detailed are parallel to the centerline of the structure. Forms shall allow for the outer 5 ft. to slope 1”. Concrete slab panel widths may vary from 5 to 30 ft. provided sections are of equal size and shall conform to the slopes as shown. No abrupt plan changes of horizontal joints will be permitted unless approved by the Engineer. Unless otherwise permitted, the Contractor shall pour alternating concrete panels to help reduce shrinkage cracking.

3.2 Granular backfill shall be placed and compacted to assure a proper bed, as detailed.

3.3 Welded wire fabric, of the type specified, shall be placed as detailed. Other wire fabric patterns may be substituted provided an equal quantity of steel is supplied for each square foot of area.

3.3.1 The fabric shall be placed at least 3” from all concrete surfaces and need not be continuous through any joints, but must be lapped with a minimum edge lap of 3” or 1/2 mesh size and a minimum end lap of 6” or 1 mesh size.

3.4 Preformed joint filler shall be placed along abutment or pier faces as detailed or ordered.

3.5 After curing in accordance with [520.3.10.1](#), the entire surface shall be treated in accordance with [Section 534](#) unless otherwise ordered.

**Method of Measurement**

4.1 Slope paving, of the type specified, will not be measured, but shall be the square foot final pay quantities in accordance with [109.11](#) for slope paving required as shown on the plans. Reinforcing fabric and preformed joint filler will not be measured.

**Basis of Payment**

5.1 Slope paving, of the type specified, is a final pay quantity item and will be paid for at the Contract unit price per square foot complete in place in accordance with [109.11](#). Excavation, paving material, reinforcing fabric and joint filler shall be subsidiary to slope paving of the type specified.

5.1.1 Granular backfill will be paid for under [209.1](#).

5.1.2 Concrete sealer will be paid for under [Section 534](#).

**Pay item and unit:**

582.1	Slope Paving with Concrete (F)	Square Yard
582.5	Slope Paving with Granite Slabs (F)	Square Yard

# SLOPE PAVING WITH CONCRETE DETAILS

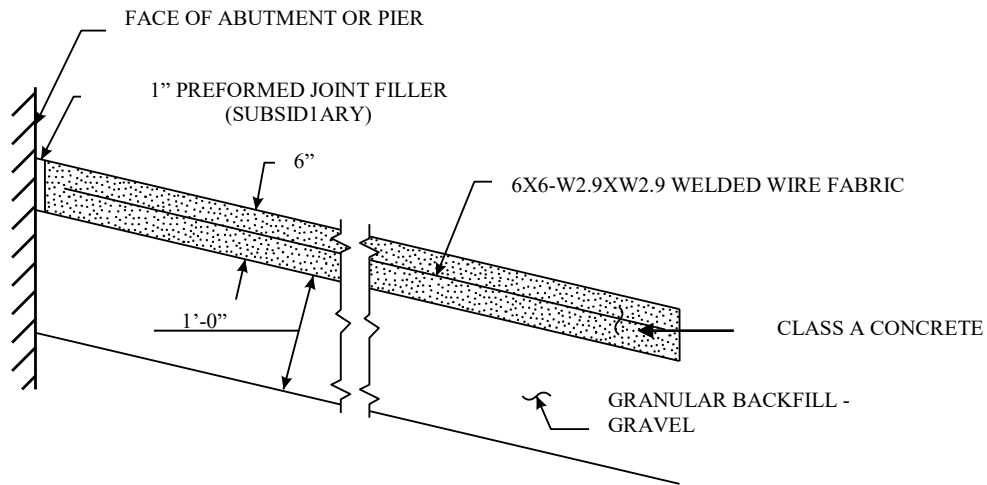

DETAIL FOR TYPICAL 4: 1 SLOPE OR LESS

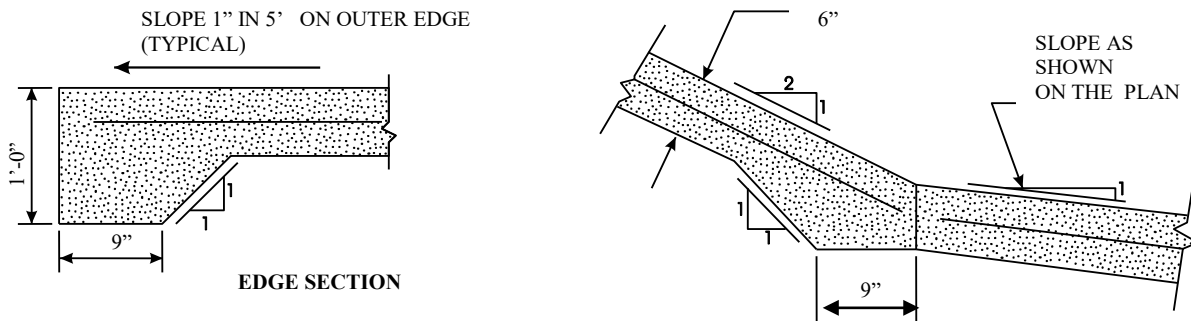
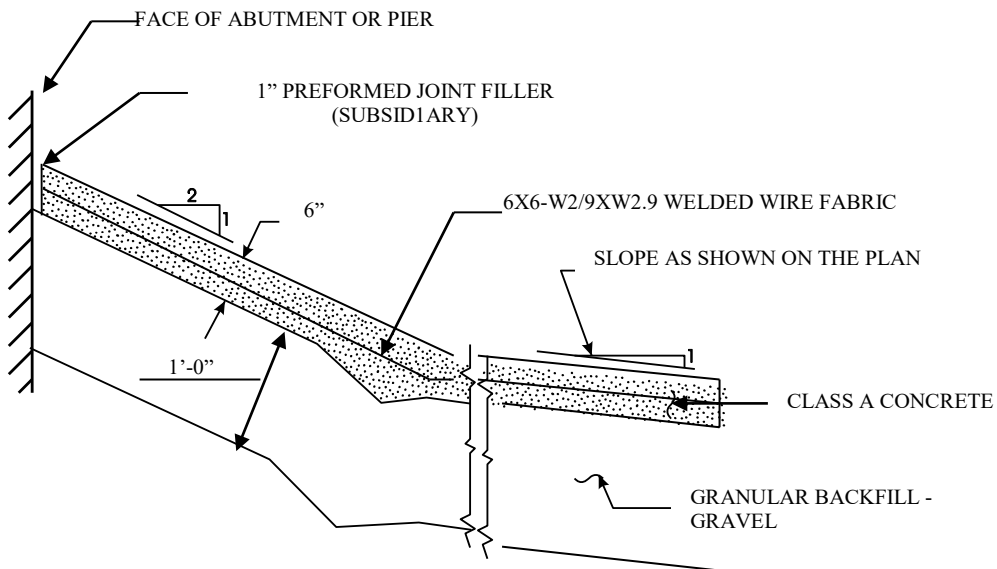

DETAIL FOR TYPICAL 6: 1 OR 4: 1 SLOPE TO A 2: 1 SLOPE

**SECTION 583 -- RIPRAP****Description**

**1.1** This work shall consist of furnishing and placing riprap as shown on the plans or ordered. Riprap is typically required for erosion protection of bridge structures in waterways, for active waterway channel slopes and bottoms, and for intermittent waterway channels where the Engineer determines riprap protection is required to resist expected high water flow velocities.

**Materials**

**2.1** Riprap shall be quarry stone of approved quality, hard, durable, sub-angular to angular in shape, resistant to weathering and free from structural defects such as weak seams and cracks.

**2.1.1** The suitable shape of the individual stones shall be angular, meeting the gradation in 2.1.1.2 to create interlocking riprap to provide stability of the slope or channel. Round, thin and platy, elongated or needle-like shapes shall not be used.

**2.1.1.1** The suitable riprap stone shape is determined by the Length to Thickness ratio, where Length is the longest dimension and Thickness is the shortest dimension, measured in perpendicular axes to each other. The suitable riprap stone shape shall have a length to thickness ratio of no greater than 3.

**2.1.1.2** The gradation requirements of the riprap classes in Table 583-1 are based on the stone size Width, the largest dimension perpendicular to the Length and Thickness, and the distribution of stone sizes by volume. The volume distribution requires that 15 percent of the stone in the mass shall be no larger than the volume shown in the table (< 15% column), and 15 percent of the stone in the mass shall be no smaller than the volume shown in the table (> 85% column). The remaining 70 percent of the stone in the mass shall have a volume between these requirements, averaging to the volume shown in the table (15% - 85% column). None of the stones in the mass shall exceed the maximum volume shown in the table (Maximum column).

**Table 583-1**

Riprap Classes and Sizes			Percentage Distribution of Particle Sizes by Volume (cubic feet)			
Class	Nominal Size (in)	Maximum Size (in)	< 15%	15% – 85%	> 85%	Maximum
I	6	12	0.05	0.14	0.31	1.0
III	12	24	0.4	1.0	2.5	6.5
V	18	36	1.3	3.5	8.5	22
VII	24	48	3	8	19	53
IX	36	72	10	27	65	179

Note: Nominal Size and Maximum Size are based on the Width dimension of the stone. The riprap classes conform to the standard classes described in the FHWA HEC-23 publication.

**2.1.2** The sources from which the stone is obtained shall be selected well in advance of the time when the material will be required in the field. The acceptability of the riprap stone shape and grading will be determined by the Engineer.

**2.1.3** Control of the gradation will be completed by visual inspection approval by the Engineer of a stockpile at the quarry or other agreed site. Mechanical equipment as needed to assist in checking the stockpile gradation shall be provided by the Contractor. Stockpile replenishment will require re-approval.

**2.2** Gravel blanket material shall conform to [209.2.1.2](#).

**2.3** Geotextile shall conform to [593.2](#).

**Construction Requirements**

**3.1 Preparation of slopes.** Slopes that will be covered by riprap shall be free of brush, trees, stumps, and other organic material and shall be graded to a smooth surface. All soft material shall be removed to the depth shown on the plans or as directed and replaced with approved material per 203.3.6. It is the Contractor's responsibility to protect embankments and excavated slopes from erosion during construction of the riprap covered slope.

**3.2 Gravel blanket construction.** When called for on the plans, the gravel blanket shall be placed on the prepared area to the specified thickness in one operation, using methods which will not cause segregation of particle sizes within the layer. The surface of the finished layer shall be even and free from mounds or windrows.

**3.3 Geotextile placement.** Geotextile shall be placed in accordance with [593.3](#).

**3.4 Riprap placement.** Riprap shall be constructed to the dimensions shown on the plans or as directed by the Engineer.

**3.4.1** Placement of riprap shall be conducted as soon as possible after gravel blanket or geotextile placement.

**3.4.2** Placement of the riprap shall be started at the toe (key trench) and progress up the slope. The key trench at the bottom of the riprap shall be constructed as shown on the plans. If bedrock is encountered at the key trench it shall be brought to the attention of the Engineer to determine if modification to the riprap installation is needed.

**3.4.3** Riprap shall be placed over geotextile by methods that do not stretch, tear, puncture or reposition the fabric. Riprap smaller than 1.5 cu. ft. in volume shall be placed with drop heights of less than 3 ft. to the placement surface. Riprap greater than 1.5 cu. ft. in volume shall be placed with no free fall height.

**3.4.4** Equipment such as a clamshell, orange-peel bucket, skip or hydraulic excavator shall be used to place the riprap so it is well distributed and there are no large accumulations of either the larger or smaller sizes of stone. Dump trucks or front-end loaders tracked or wheeled vehicles shall not be used since they can destroy the interlocking integrity of the stone when driven over previously placed riprap. Placing the riprap by end dumping on the slopes will cause segregation and will not be permitted.

**3.4.5** The riprap shall be placed in a manner which produces a well-graded mass. The larger stones shall be well distributed and the entire mass of riprap shall conform approximately to the gradation specified. Hand placing or rearranging of individual stones by mechanical equipment may be required to the extent necessary to secure the uniformity of gradation and surface specified. Fill voids between larger stones with small stones to ensure interlocking between the riprap.

**3.4.6** After the riprap is in place, it shall be compacted by impacting (ramming) the exposed surface to produce a tight, locked surface, not varying more than 6" from the elevations shown on the plans.

**3.4.7** Riprap placed in water requires close observation and increased quality control to ensure the required thickness, gradation and coverage is achieved.

#### Method of Measurement

**4.1** Riprap will be measured by the cubic yard.

**4.1.1** If the Engineer determines that in-place measurement is impracticable, the quantity for payment will be determined by loose measure in the hauling vehicle on the basis that 1 cubic yard vehicle measure is equivalent to 0.7 cubic yard in place.

#### Basis of Payment

**5.1** The accepted quantity of riprap will be paid for at the Contract unit price per cubic yard (cubic meter) complete in place.

**5.1.1** Only when the stone is examined in accordance with 2.1 and examination proves the gradation to be acceptable will payment be made as provided in [109.04](#).

**5.1.2** Gravel blanket material specified or ordered will be paid for under [Section 209](#).

**5.1.3** Geotextile specified or ordered will be paid for under [Section 593](#).

**5.1.4** The accepted quantity of excavation required for placing riprap and for placing any underlying gravel blanket will be paid for under the item of excavation being performed. Excavation above refers only to excavation of original ground or to material ordered removed not shown on the plans.

**5.1.5** Free borrow will not be required to replace the accepted quantity of stone obtained from the excavation. However, when the plans do not call for borrow but the quantity of material removed from excavation for use under this item requires the Contractor to furnish borrow to complete the work, such borrow will be subsidiary.

**5.1.6** Replacement slope material resulting from the requirements of 3.1 will be paid in accordance with [203.5.1.9](#).

#### Pay item and unit:

583.1	Riprap, Class I	Cubic Yard
583.3	Riprap, Class III	Cubic Yard
583.5	Riprap, Class V	Cubic Yard
583.7	Riprap, Class VII	Cubic Yard
583.9	Riprap, Class IX	Cubic Yard

**SECTION 585 -- STONE FILL****Description**

**1.1** This work shall consist of furnishing and placing a dense stone fill at the locations shown on the plans or ordered. Stone Fill is typically required for stability of embankment fill and soil cut slopes steeper than 2 horizontal to 1 vertical, although slopes at a flatter grade with water seepage or subject to submergence, such as in water quality treatment basins, could require stone fill. Stone fill is also used for erosion protection at pipe outlets, in drainage channels and for other drainage structures where expected water flows and velocities may require it.

**Materials**

**2.1** Stone for stone fill shall be approved quarry stone, or broken rock of a hard, sound, and durable quality. The stones and spalls shall be so graded as to produce a dense fill with a minimum of voids.

**2.1.1** Class A stone shall be irregular in shape with approximately 50 percent of the mass having a minimum volume of 12 ft<sup>3</sup>, approximately 30 percent of the mass ranging between 3 and 12 ft<sup>3</sup>, approximately 10 percent of the mass ranging between 1 and 3 ft<sup>3</sup>, and the remainder of the mass composed of spalls.

**2.1.2** Class B stone shall be irregular in shape with approximately 50 percent of the mass having a minimum volume of 3 ft<sup>3</sup>, approximately 40 percent of the mass ranging between 1 and 3 ft<sup>3</sup>, and the remainder of the mass composed of spalls.

**2.1.3** Class C stone shall consist of clean, durable fragments of ledge rock of uniform quality, reasonably free from thin or elongated pieces. The stone shall be made from rock which is free from topsoil and other organic material. The stone shall be graded as follows:

Sieve Size	Percentage by Weight Passing
12 in	100
4 in	50 - 90
1-1/2 in	0 - 30
3/4 in	0 - 10

**2.1.4** Class D stone shall conform to [Table 520-3](#) - Coarse Aggregate, Standard Stone Size No. 467.

**2.1.5** Spalls for filling voids shall be stones or broken rock ranging downward from a maximum size of 1 ft<sup>3</sup>.

**2.2** Gravel blanket material shall conform to [209.2.1.2](#).

**2.3** Geotextile shall conform to [Section 593](#).

**Construction Requirements**

**3.1** Stones and spalls for stone fill shall be deposited and graded to eliminate voids and obtain a dense mass throughout the course. The spalls shall be tamped into place using an equipment bucket or other approved method.

**3.1.1** When stone fill is placed on a slope, the stones shall be deposited in such a manner as not to dislodge the underlying material unnecessarily.

**3.1.2** When stone fill is placed on a geotextile, it shall be deposited in a manner to maintain the integrity of the geotextile.

**3.2** When gravel blanket is shown or ordered, the gravel shall be placed in layers not exceeding 12" in depth unless otherwise ordered.

**3.3** The completed surface shall approximate the lines and grades shown or ordered. When ordered, stone placed over 1 ft. outside or above such lines and grades shall be removed.

**3.4** Stone fill (Bridge) shall be placed within the limits shown on the plans.

**Method of Measurement**

**4.1** Stone fill will be measured by the cubic yard and in accordance with [109.01](#).

**Basis of Payment**

**5.1** The accepted quantity of stone fill of the class specified will be paid for at the Contract unit price per cubic yard complete in place.

**5.2** Gravel blanket material specified or ordered will be paid for under [Section 209](#).

**5.3** Geotextile specified or ordered will be paid for under [Section 593](#).

**5.4** The accepted quantity of excavation required for placing stone fill and for placing any underlying gravel blanket will be paid for under the item of excavation being performed. Excavation herein refers only to excavation of original ground or to material ordered removed not shown on the plans.

**5.5** Free borrow will not be required to replace the accepted quantity of stone obtained from the excavation. However, when the plans do not call for borrow, but the quantity of material removed from excavation for use under this item requires the Contractor to furnish borrow to complete the work, such borrow will be subsidiary.

**Pay items and units:**

585.1	Stone Fill, Class A	Cubic Yard
585.2	Stone Fill, Class B	Cubic Yard
585.21	Stone Fill, Class B (Bridge)	Cubic Yard
585.3	Stone Fill, Class C	Cubic Yard
585.4	Stone Fill, Class D	Cubic Yard

\_\_\_\_\_  
\_\_\_\_\_

\_\_\_\_\_  
\_\_\_\_\_

## SECTION 591

### **SECTION 591 -- STRUCTURAL PLATE PIPES, PIPE-ARCHES, AND ARCHES**

#### **Description**

**1.1** This work shall consist of furnishing and installing steel structural plate pipes, pipe-arches, or arches, of the size and type specified, at the location shown on the plans or ordered.

**1.1.1** Structural plate pipe as mill fabricated shall be elliptical.

#### **Materials**

**2.1** Materials and design of plates and metal bearings shall be as specified on the plans or in the AASHTO "LRFD Bridge Design Specifications" unless otherwise provided hereinafter.

**2.2** Plates and fasteners shall conform to AASHTO M 167.

**2.2.1** Dimensions, including the thickness of plates, shall be as shown on the plans.

**2.3 Elliptical requirements for pipe.** Pipe under the item of structural plate pipe shall be fabricated elliptically so as to increase the vertical diameter 5 percent and decrease the horizontal diameter 5 percent. These dimensions shall be subject to manufacturing tolerances.

**2.4** Backfill shall conform to 209.2.1.2.

#### **Construction Requirements**

##### **3.1 General.**

**3.1.1** The Contractor shall provide for the temporary diversion of water in order to permit the installation of the structure in a reasonably dry trench unless otherwise permitted.

**3.1.2** Fabrication, assembly, and installation of structural plate structures shall be as specified in the AASHTO "LRFD Bridge Construction Specifications" unless otherwise specified hereinafter.

**3.1.3** Where soft or other unsuitable material is encountered, all of such unsuitable material shall be removed for the depth shown or ordered. See Figure 1-a.

**3.1.4** Where bedrock or other incompressible material is encountered, it shall be removed to a minimum of 1 ft. below the flow line. See Figure 1-b.

**3.1.5** Granular backfill or other approved material shall be used to backfill the spaces left by the excavation of material removed in accordance with 3.1.3 and 3.1.4. The material shall be uniformly compacted by the use of lightweight construction equipment.

##### **3.2 Bedding of Pipe and Pipe-Arches.**

**3.2.1** The structure shall be placed at the designated location on a prepared foundation of granular backfill so that the flow line of the structure will conform to the required grade. Pipe or pipe-arch structures shall be set on a uniformly compacted bed of fine granular material 1 ft. deep, or as ordered, below the bottom of the structure. The bed shall extend under the structure and at least 1 ft. beyond each side of the span. See Figure 1-c.

**3.2.2** The granular backfill shall be carefully shaped by means of a template to fit the lower exterior of the structure, forming a trench equal in depth to at least 10 percent of the height in the case of a pipe-arch and 15 percent of the height in the case of a pipe. Care shall be taken to maintain the height of the edges of the bedding. Reasonable latitude will be permitted to allow for the field bolting of both circumferential and longitudinal seams of plates that are in the area of the shaped trench. When the top of the granular backfill is above the natural ground, fill for lateral support shall be constructed on each side of the granular backfill for a distance of approximately 2 times the span of the pipe or pipe-arch. See Figure 1-c.



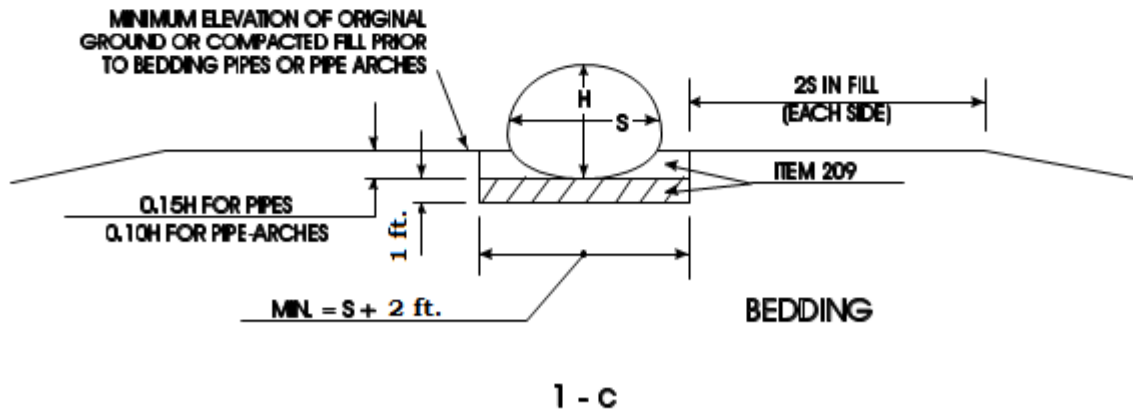
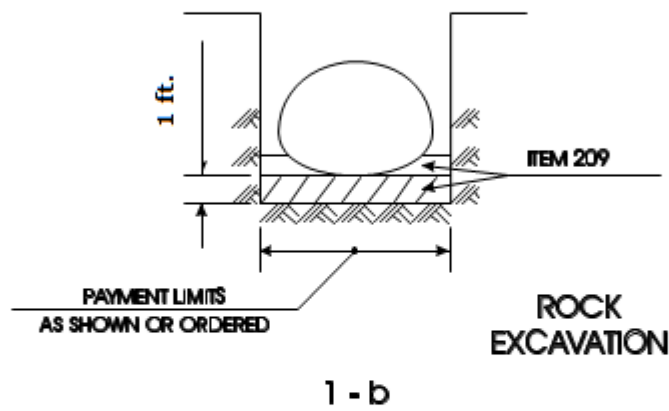
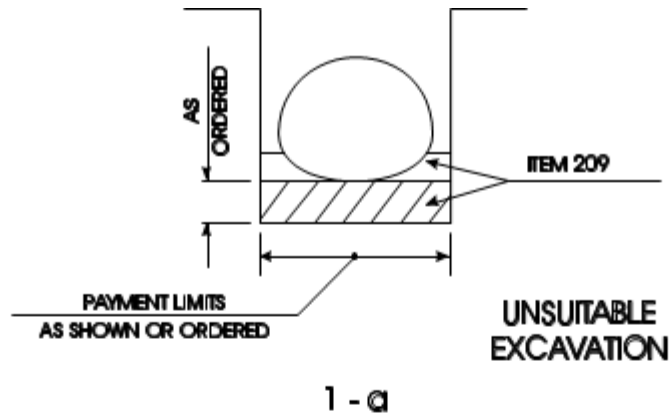

FIGURE 1 - STRUCTURAL PLATE PIPE AND PIPE-ARCH DETAILS

## SECTION 591

### 3.3 Arch Substructure.

3.3.1 The substructure for the arch shall be constructed as shown on the plans.

### 3.4 Structure Assembly.

3.4.1 The plates for the structure shall be assembled according to the manufacturer's assembly instructions and the plans.

3.4.2 Pipe or pipe-arch structures may be assembled in their final location or partially or completely assembled elsewhere and then placed on the prepared foundation.

3.4.3 Arches shall be erected in place upon the prepared substructure.

3.4.4 The structure shall be assembled by partial bolting with the plate location and sequence of plates as shown on the Fabricator's drawings. Complete bolting and hand tightening shall follow the assembly no closer than two or three plate rings. Final tightening shall be carried out progressively and uniformly. Whenever possible, final tightening shall be completed by working from the outside and inside of the structure at the same time with the operation repeated as required, making sure that all bolts are tight. With pipe, the final tightening shall start at the bottom seams and work progressively to the top seams on each side.

3.4.5 When assembling structures intended to be used as pedestrian or animal passes, all bolts shall be placed with bolt heads on the inside of the structure.

3.4.6 Pipes shall normally be installed with the longer axis vertical.

3.4.7 Anchor bolts shall be installed when and as shown on the plans.

3.4.8 After erection of an arch and before backfilling is started, the groove of the metal bearing channel shall be filled with asphalt filler to the level of the top of the concrete.

3.4.9 When completed, the structure shall be true to the required alignment and grade and properly placed as to the center line of the road.

### 3.5 Backfilling Structural Plate Pipe and Pipe-Arch.

3.5.1 All backfill material adjacent to a pipe or pipe-arch shall be approved compactable soil or granular fill material and shall not contain stones retained on a 3" screen. This soil shall extend to a height of at least 1 ft. above the top of the structure and the width shall fill the trench or in fills extend for a width on each side of the structure equal to twice the diameter or 12 ft. whichever is less, with the slopes normal to the structure not steeper than 6:1.

3.5.2 This material shall be uniformly compacted at near optimum moisture content, in layers not exceeding 6" in compacted thickness, by pneumatic tampers, vibratory compactors, or other approved means. Care shall be exercised to compact the backfill thoroughly under the haunches of the pipe or pipe-arch and to ensure that the backfill soil is in intimate contact with the side of the structure. The backfill shall be brought up evenly on both sides of the structure along the full length installed. Fill at the sides may be compacted by rolling or operating heavy equipment parallel with the structure, provided care is taken to avoid displacement or injury. Material in the vicinity of pipes or pipe-arches shall be compacted to not less than 95 percent of AASHTO T 99, Method C.

3.5.3 The Contractor shall place a protecting cover of earth or other approved material over the structure before allowing equipment or traffic to pass over it. The protective cover shall be of a thickness to prevent overstress and damage to the pipe as specified by the pipe manufacturer.

### 3.6 Arch Backfill.

3.6.1 When backfilling an arch before headwalls are placed, the first material shall be placed in the form of ramps constructed on both sides of the arch, at right angles to the axis of the arch and midway of the ends. These two ramps shall be as narrow as practicable, consistent with thorough compaction, and shall be brought up uniformly on both sides of the arch until the ramps meet and material is placed at least 1 ft. above the top of the arch. After the ramps have been joined, the remainder of the backfill shall be placed and compacted, widening the ramps uniformly along both sides and toward each end of the arch to avoid springing the arch out of shape.

3.6.2 If the headwalls are built before the arch is backfilled, the filling material shall first be placed adjacent to one headwall until the top of the arch is reached, after which the fill shall be dumped from the top of the arch toward the other headwall, with care being taken to deposit the material evenly on both sides of the arch.

3.6.3 In all cases, the filling material shall be thoroughly but not excessively tamped.

3.6.4 Puddling the backfill will not be permitted.

**3.6.5** Arches shall be protected as required in 3.5.3.

### **3.7 Workmanship.**

**3.7.1** It is the intent of these specifications that in addition to compliance with the details of construction, the completed structure shall show careful and finished workmanship in all particulars.

**3.7.2** Structures on which the spelter coating has been bruised or broken, either in the shop or in shipping, or which show defective workmanship, shall be rejected or repaired as directed. This requirement applies not only to the individual plates but to the shipment of any Contract item as a whole.

**3.7.2.1** The following defects are specified as constituting poor workmanship, and the presence of any or all of them in any individual culvert plate or in general in any shipment shall constitute sufficient cause for rejection:

- (a) Uneven laps
- (b) Variation from a straight center line
- (c) Ragged edges
- (d) Loose or unevenly lined or spaced bolts
- (e) Illegible brand
- (f) Bruised, scaled, or broken spelter coating
- (g) Dents or bends in the metal itself

**3.7.2.2** Damaged spelter coating may be repaired by thoroughly wire brushing the damaged area and painting it with 2 coats of an approved zinc-rich primer.

#### **Method of Measurement**

**4.1** Structural plate pipes, pipe-arches and arches will not be measured, but shall be the pound final pay quantity in accordance with 109.11 for the structural plate structure required as shown on the plans. When more than one structure is specified in the Contract, separate item numbers will be used for each separate and complete structure.

#### **Basis of Payment**

**5.1** Structural plate pipes, pipe-arches and arches are final pay quantity items and will be paid for at the Contract unit price per pound complete in place in accordance with 109.11.

**5.2** Excavation will be paid for under Section 504 regardless of the span.

**5.3** Granular backfill below the flow line or as shown on the plans will be paid for under Section 209.

**5.4** Paving of invert, if required, will be paid for under the hand method of Section 403.

**5.5** Concrete for arch substructure will be paid for under Section 520.

#### **Pay items and units:**

591.1	Structural Plate Pipe (F)	Pound
591.2	Structural Plate Pipe-Arch (F)	Pound
591.3	Structural Plate Arch (F)	Pound

**SECTION 593 -- GEOTEXTILE****Description**

**1.1** This work shall consist of furnishing and installing geotextile fabric as shown on the plans or as ordered, including any labor and materials needed to anchor, splice, or repair the geotextile.

**Materials****2.1 General.**

**2.1.1** Geotextile shall be a product tested under the AASHTO National Transportation Product Evaluation Program (NTPEP) and included on the [Qualified Products List](#) for the Application, Strength Class, and Structure specified. Manufactures of geotextiles and those marketing geotextiles made by others as a “Private Labeler” shall participate in and maintain compliance with the NTPEP audit program for geotextiles. Manufacturer’s labels providing product name, AASHTO M288 class, roll number, and production date shall be affixed to both ends of the roll.

**2.1.2** All geotextile properties referenced in the specifications and certified by the Contractor, with the exception of Apparent Opening Size (AOS), shall be considered minimum average roll values in the weaker principal direction (i.e., the average test results for any sampled roll in a lot shall meet or exceed the minimum values specified). Values for AOS shall represent maximum average roll values.

**2.1.3** Fibers used in the manufacture of geotextiles, and threads used in joining geotextiles by sewing, shall meet the requirements of the most current version of the applicable sections of AASHTO M 288.

**2.1.4** Geotextile shall exhibit an ultraviolet stability (retained strength) of at least 50% after 500 hours of exposure, measured in accordance with ASTM D 4355.

**2.2 Application.**

Following are the basic Applications of geotextile included under this specification. Applications are described according to their most common use(s) and may not include every function for which a geotextile is specified.

**2.2.1** Application 1 – Subsurface Drainage. Geotextile for this Application consists of fabric placed against a soil to allow for long-term passage of water into a subsurface drain system while retaining the in situ soil.

**2.2.2** Application 2 – Separation. Geotextile for this Application consists of fabric placed to prevent mixing of in situ or subgrade soil with aggregate cover materials.

**2.2.3** Application 3 – Stabilization. Geotextile for this Application consists of fabric placed in wet, saturated conditions to provide the coincident functions of separation and filtration. This Application may also be specified for geotextiles used to provide the function of reinforcement.

**2.2.4** Application 4 – Permanent Erosion Control. Geotextile for this Application consists of fabric placed below riprap or other armor systems to prevent soil loss and/or instability of the erosion control system.

**2.3 Strength Class. Following are the basic Strength Classes of geotextile included under this specification:**

**2.3.1** Class 1, Class 2, and Class 3. Geotextile specified as Class 1 (high strength), Class 2 (medium strength), or Class 3 (low strength) shall meet the applicable requirements of AASHTO M 288, Table 1, including sewn seam strength when sewn seams are used. A higher strength geotextile may be substituted for a lower strength geotextile provided all other specification requirements are met.

**2.3.2** Class 0. Geotextile specified as Class 0 (extra high strength) shall meet the following minimum requirements:

Geotextile Property	Test Method	Property Requirement Pounds
Grab Tensile Strength	ASTM D 4632	375
Sewn Seam Strength	ASTM D 4632	335
Tear Strength	ASTM D 4533	135
Puncture Strength	ASTM D 6241	1237

**2.4 Structure.** The Contract Item Number for geotextile includes a designation for Structure that defines the basic composition of the fabric. Geotextile shall conform to the specified structure as identified by the Item Number.

**2.5 Permittivity and Apparent Opening Size (AOS).** Geotextile shall meet the requirements for permittivity and Apparent Opening Size (AOS) as described in the Geotextile Qualification Criteria Document. Located on the [Department’s Website](#).

**2.6** Each roll shall be clearly labeled so as to easily identify the product in the field. The label shall include as a minimum the manufacturer's name, product name and number, and the Contract Item name and number.

**2.7 Staples or Pins.** Staples or pins required to hold the geotextile prior to placing overlying materials shall be those prescribed by the geotextile manufacturer.

### Construction Requirements

**3.1 Protection of Geotextile.** To prevent damage to the fabric, the Contractor shall exercise necessary care while transporting, storing, and installing the fabric. Prior to installation, the fabric shall be protected from weather, direct sunlight or other ultra-violet exposure, and from dust, mud, dirt, debris, and other elements which may affect its performance. Fabric that is torn, punctured, or otherwise damaged shall not be placed. After placement, fabric shall be covered within 5 days. Traffic or construction equipment shall not be permitted directly on the geotextile.

**3.2 Placement of Geotextile and Overlying Materials.** The geotextile and overlying materials shall be placed in accordance with the plans, the manufacturer's requirements, and the following:

**3.2.1 General.** Prior to placement of the fabric, the site shall be prepared to provide a smooth surface which is free from debris, obstructions, and depressions which could result in gaps, tears, or punctures in the fabric during cover operations.

**3.2.1.1** Successive sheets placed above water shall be overlapped by a minimum of 18". Sheets placed below water shall be sewn or overlapped by a minimum of 3 feet. Larger overlaps may be called for on the plans or required by the Engineer in soft soil conditions or if gaps between adjacent sheets occur during placement of overlying material. Pins or staples may be used to anchor the fabric as directed by the Engineer.

**3.2.2 Subsurface Drainage.** Trench excavation shall be done in accordance with details shown on the plans. In all instances, excavation shall be done in such a way so as to prevent large voids from occurring in the sides and bottom of the trench.

**3.2.2.1** The geotextile shall be placed loosely with no wrinkles or folds, and with no void spaces between the geotextile and the ground surface. Successive sheets shall be shingled such that the upstream sheet is placed over the downstream sheet.

**3.2.2.2** Placement of drainage aggregate shall proceed immediately following placement of the geotextile. The geotextile shall be covered with a minimum of 12" of loosely placed aggregate prior to compaction. If a collector pipe is to be installed in the trench, a bedding layer of drainage aggregate shall be placed below the pipe, with the remainder of the aggregate placed to the minimum required construction depth.

**3.2.2.3** After placing the drainage aggregate, the geotextile shall be folded over the top of the aggregate in a manner that produces the overlap shown on the plans. In no case shall the minimum overlap be less than 12".

**3.2.3 Separation/Stabilization.** The installation site shall be prepared by clearing, grubbing, and removal of vegetation and topsoil. The site shall be excavated or filled to the proper grade as shown on the plans or as ordered. The Engineer may order that soft spots and unsuitable areas identified during site preparation or subsequent proof rolling be excavated, backfilled, and compacted with suitable materials.

**3.2.3.1** The geotextile shall be laid smooth without wrinkles or folds on the prepared subgrade, except that it may be folded or cut to conform to curves. Joints and overlaps shall be in the direction shown on the plans or as ordered by the Engineer. The folds or overlaps shall be held in place by pins, staples, or piles of fill or rock.

**3.2.3.2** Overlying fill or aggregate materials shall be placed by end dumping onto the geotextile from the edge of the geotextile, or over previously placed materials. Construction vehicles shall not be allowed directly on the geotextile. Materials shall be placed such that at least the minimum specified lift thickness is between the geotextile and equipment tires or tracks at all times. Turning of vehicles shall not be allowed on the first lift above the geotextile.

**3.2.3.2.1** On very soft subgrades, the fill or aggregate shall be spread to the proper lift thickness as soon as possible after dumping to minimize the potential of localized subgrade failure due to concentrated loading.

**3.2.3.2.2** In stabilization applications, vibratory compaction equipment on the initial lift of fill or aggregate material may be prohibited by the Engineer to prevent damage to the geotextile.

**3.2.3.3** Placement procedures that result in instability or damage to the geotextile shall be modified to eliminate further damage. The Engineer may order remedial measures such as increasing the initial lift thickness or decreasing equipment loads.

**3.2.3.4** Geotextile placed below temporary fills shall be completely removed immediately after the fill is removed. Geotextile salvaged from use under temporary fills shall not be used for any permanent application in the project unless approved by the Engineer.

**3.2.4 Permanent Erosion Control.** The geotextile shall be placed in intimate contact with the soils without wrinkles or folds, and anchored on a smooth graded surface approved by the Engineer. The geotextile shall be placed in such a manner that placement

## SECTION 593

of the overlying materials will not excessively stretch or tear the geotextile. Anchoring of the terminal ends of the geotextile shall be accomplished through the use of key trenches or aprons at the crest and toe of the slope as shown on the plans.

**3.2.4.1** The geotextile shall be placed with the machine direction (long direction of the roll) parallel to the direction of water flow, which is normally parallel to the slope for erosion control runoff and wave action, and parallel to the stream or channel in the case of stream bank and channel protection. When overlapping, the fabric shall be placed such that the uphill sheet is placed over the downhill sheet, and the upstream sheet is placed over the downstream sheet. In cases where wave action or multidirectional flow is anticipated, all seams perpendicular to the direction of flow shall be sewn.

**3.2.4.2** The armor system placement shall begin at the toe and proceed up the slope. Placement shall take place so as to avoid stretching, puncturing, and tearing of the geotextile. Particles smaller than 1.5 cubic feet, shall be placed with drop heights less than 3 feet. Particles greater than 1.5 cubic feet shall be placed with no free fall. Drop heights exceeding the distance specified above may be allowed by the Engineer if field tests demonstrate that larger drop heights will not result in damage to the fabric. In no case shall stones be rolled or pushed onto the geotextile.

**3.2.4.3** The geotextile and armor materials shall be placed the same day in underwater applications.

**3.2.4.4** Field monitoring shall be performed to verify that the armor system placement does not damage the geotextile. Fabric which is damaged as a result of careless or improper placement of stone, grading techniques, or equipment traffic above the stone shall be repaired or replaced in accordance with 3.3.

**3.3 Repair of Geotextile.** Fabric that is damaged during or after placement shall be replaced or repaired by stitching or patching at the expense of the Contractor. Patches shall be of the same material as the placed geotextile. The patch shall be joined to the existing fabric using overlapped seams as specified above or as directed by the Engineer.

**3.3.1** The Contractor shall modify his placement or covering procedures to eliminate further or repeated damage from occurring.

**3.4 Sewn Seams.** Sewn seams, if specified, ordered, or allowed, shall result in a joint at least as strong as the sewn seam strength requirements described in 2.3. Field or factory seaming will be permitted unless otherwise specified. Sewn seams shall be lapped a minimum of 4" and double sewn using Stitch Type 401 as depicted in ASTM D 6193. Either a "J" seam (Type SSn-2) or "Butterfly" seam (Type SSd-2) shall be used as shown in Figure 1.

**3.4.1** All seams shall be subject to the approval of the Engineer. Sewn seams shall be positioned on the exposed side of the fabric to allow for inspection and/or repair of the fabricated joint. Seams shall not be positioned as shown in Figure 2.

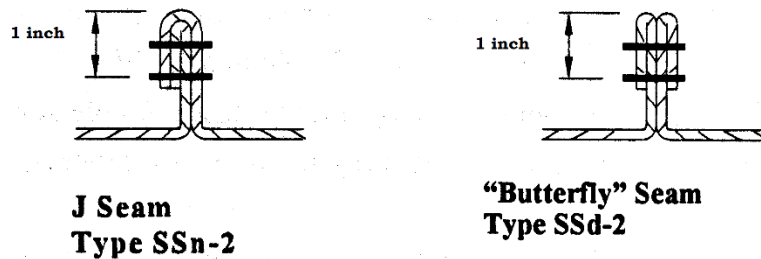
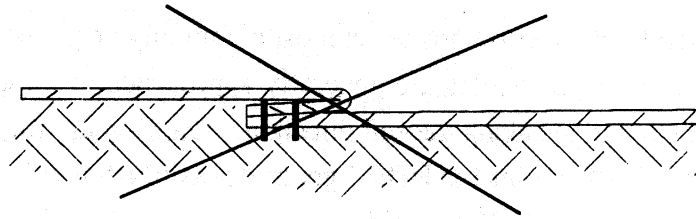

FIGURE 1



**Cannot Inspect or Repair**

**FIGURE 2**

**Method of Measurement**

**4.1** Geotextile will be measured by the square yard as determined by the actual surface measurements of the covered area. Additional material used for overlaps and repairs will not be measured.

**Basis of Payment**

**5.1** The accepted quantity of geotextile will be paid for at the Contract unit price per square yard for the application, strength class, and structure specified, complete in place. The cost of all labor or materials used to anchor, splice, or repair the geotextile is considered subsidiary to the geotextile installation. Removal of temporary geotextile will be considered subsidiary to the geotextile installation.

**Pay Item and Unit:**

593.A B C                      Square Yard

**Key:**

**A= Application**

- 1 = Subsurface Drainage
- 2 = Separation
- 3 = Stabilization
- 4 = Permanent Erosion Control

**B = Strength Class**

- 0 = Class 0
- 1 = Class 1
- 2 = Class 2
- 3 = Class 3

**C = Structure**

- 0 = Contractor Option
- 1 = Nonwoven (Default for Application 1 & Application 4)
- 2 = Monofilament, Woven
- 3 = Slit Filament, Woven





## DIVISION 600 -- INCIDENTAL CONSTRUCTION

## SECTION 603 -- CULVERTS AND STORM DRAINS

## Description

**1.1** This work shall consist of furnishing and installing, or removing and relaying, pipes, pipe end sections, pipe sleeves, and post installation video inspection at the locations shown or ordered, including the necessary joints, fittings, and connections as required. Sawed pavement, common structure excavation to the depth specified in 206.4.1, secondary excavation required in the imperfect trench method, bedding, shaping of bedding, and backfill shall be included in this work.

## Materials

**2.1 Reinforced Concrete Pipe, Circular.**

**2.1.1 Fabricator Certification.** Concrete pipe manufacturing plants shall be certified by the American Concrete Pipe Association through its "Quality Cast" plant certification program. The Fabricator shall submit proof of certification at delivery.

**2.1.2** This pipe shall conform to the requirements of AASHTO M 170, except as follows: When fly-ash is used, only Class F, in accordance with AASHTO M 295 will be allowed. Wall A thickness will be allowed in Class III pipe only. When the plans call for reinforced concrete pipe capable of withstanding an ultimate load greater than 3750 D, the design requirements of Class V shall be met with further provision that the pipe will withstand the ultimate D-load specified.

**2.1.3** Basis of acceptance of concrete pipe shall conform to AASHTO M 170, Section 5.1.1. Test requirements shall be as provided in Section 11 with the further provision that the pipe will withstand an additional ten percent of the D-load specified or brought to destruction. Permissible variation in pipe tolerances shall conform to AASHTO M 170, Section 12.

**2.1.4** Workmanship and finish shall conform to AASHTO M 170, Section 12. Pipe shall be subject to rejection on account of failure to conform to any of the specification requirements of AASHTO M 170, Section 15. Individual sections of pipe may be rejected for the following reasons:

- (a) Fracture or cracks passing through the wall, except for a single end crack that does not exceed the depth of a joint.
- (b) Defects that indicate imperfect proportioning, mixing, and molding.
- (c) Surface defects indicating honey-combed or open texture.
- (d) Damaged or cracked ends where such damage would prevent making a satisfactory joint.
- (e) Any continuous crack having a surface width of 0.01" or more and extending for a length of 12" or more, regardless of position in the wall of the pipe.
- (f) The exposure of any steel in the barrel or the outside of the pipe indicating the displacement of reinforcement. Steel exposed at the ends will not be cause for rejection if a satisfactory joint can be made.

Table 603-1 - Minimum Strength Requirements

D Load to produce the ultimate load = Class	D Load to produce a 0.01 crack	AASHTO Designation Class
1500D	1000D	II
2000D	1350D	III
3000D	2000D	IV
3750D	3000D	V
4000D	---	---

**2.1.5** Markings on pipe shall conform to AASHTO M 170, Section 16 with the following information clearly marked on each section of pipe.

- (a) The pipe class and specification designation
- (b) The date of manufacture
- (c) The name or trademark of the manufacturer
- (d) Identification of the plant

**2.1.6** Concrete pipe shall be joined by using flexible water tight gaskets conforming to AASHTO M 198.

**2.2 Corrugated Metal Pipes and Pipe-Arches--Steel.**

**2.2.1** Except as provided below, steel pipes and pipe-arches shall conform to AASHTO M 36, Type I or II.

## SECTION 603

**2.2.1.1** To facilitate field jointing, the ends of individual pipe sections shall meet the requirements of Section 7.7.1 of AASHTO M 36.

**2.2.1.2** Section 9.1.3 of AASHTO M 36 does not apply.

**2.2.2** The specified thickness in the case of steel shall be as shown on the plans. The minimum thickness of steel culvert sheets shall meet the requirements of AASHTO M 218.

**Table 603-2 - Thickness and Equivalent Gauges**

Steel	
Thickness," * "	Sheet Gauge Number
0.064	16
0.079	14
0.109	12
0.138	10
0.168	8

\*Thickness measured on tangent of corrugation.

**2.2.3** Strutted pipes shall be furnished 5 percent elongated, when specified.

### 2.3 Plastic Pipe.

**2.3.1** Manufacturers of Polyvinyl Chloride (PVC) pipe and Polyethylene (PE) pipe must participate in and maintain compliance with, the AASHTO National Transportation Product Evaluation Program (NTPEP) that audits producers of plastic pipe. A certificate of compliance, as required by 106.04 shall be provided for each shipment.

**2.3.2** Polyvinyl chloride profile wall pipe shall conform to the requirements of AASHTO M 304. PVC pipe shall not be used in applications where it will be exposed to long term ultraviolet light without approved protection for the exposed area.

**2.3.3** Polyethylene pipe shall conform to the requirements of AASHTO M 294, Type C, Type S, or Type D as specified on the plans.

**2.3.4** Only soil tight pipefittings supplied or recommended by the manufacturer shall be used, unless otherwise specified.

**2.3.4.1** When watertight joints are specified, watertight pipefittings supplied or recommended by the manufacturer shall be used and shall conform to the appropriate AASHTO standard.

**2.3.5** When the item description calls for Plastic Pipe (pipe material is not specified), either polyvinyl chloride or polyethylene pipe shall be furnished and shall meet the requirements of 2.3.

**2.4 Drainage Pipe.** When the Item calls for Drainage Pipe (pipe material is not specified) either concrete pipe 2000D or plastic pipe for drainage pipe shall be furnished. Reinforced concrete pipe shall meet the requirements of 2.1. Plastic pipe shall meet the requirements of 2.3.

### 2.5 Pipe Sleeve (24" and under).

**2.5.1** Pipe sleeves for electrical conduit shall be as specified in Section 614. Other pipe sleeves shall meet the load bearing requirement as well as special design considerations.

**2.5.2** Steel pipe for pipe sleeve, bored, shall conform to ASTM A 53, with joints welded.

### 2.6 Pipe for Slope Drainage.

**2.6.1** Manufacturers of polyethylene pipe for slope drain shall conform to the requirements of 2.3.1 and AASHTO M294, Type C.

**2.6.2** The pipe coupler for polyethylene pipe shall consist of a plastic coupler and 2 stainless steel bands installed on the exterior corrugations. Slope pipe coupling bands shall engage a minimum of two full corrugations of each pipe section being joined, shall be reinforced with a minimum of three high-strength nylon ties, and in all other respects shall meet the criteria for the "Downrain Joint" category of Section 26 of the AASHTO LRFD Bridge Construction Specifications.

## 2.7 Pipe for Drives and Minor Approaches.

2.7.1 It shall be the Contractor's option to furnish reinforced concrete pipe or corrugated aluminized steel type 2 pipe, unless otherwise specified, for pipe for drives and minor approaches. Reinforced concrete pipe shall meet the requirements of 2.1. Corrugated aluminized steel pipe shall meet the requirements of 2.2. The strength or thickness shall meet the requirements of Table 3. Where cover is 2' or greater, and where load requirements can be met, polyethylene pipe, meeting the requirements of 2.3, may be used.

**Table 603-3 - Required Strength of Culvert Pipes**

Material	Diameter	Thickness, inch		Pipe Stiffness Plastic
		Strength Concrete	" Specified" Steel	
Reinforced Concrete	All	2000 D		
Corrugated Metal	12" -18"		0.064	
	24" -30"		0.079	
	36"		0.109	
Plastic (Polyethylene)	All			Reference AASHTO M294

## 2.8 End Sections.

### 2.8.1 Metal End Sections.

2.8.1.1 Steel end sections shall be galvanized, sheet or corrugated as required, conforming to the requirements of AASHTO M 36 insofar as that specification applies. Sections shall be fabricated of the thickness of metal shown on the plans. When the item calls for metal end sections, steel shall be furnished, with the minimum sheet thickness of 0.064".

2.8.1.1.1 Aluminized steel end sections shall be aluminum-coated (Type 2) conforming to the requirements of AASHTO M 36.

2.8.1.2 Galvanized bolts may be used for the assembly of end sections where more than one piece is used to form the skirt. Bolts shall conform to ASTM A 325.

2.8.2 **Concrete End Sections.** Concrete end sections shall be reinforced concrete conforming to the pertinent provisions of 2.1 and to the requirements shown on the plans. Where a single cage of reinforcement is shown on the plans, sufficient steel shall be incorporated to maintain the integrity of the piece. Unless a different class is specified, end sections conforming to Class III minimum strength pipe shall be furnished.

2.8.3 **Plastic End Sections.** Polyethylene pipe end sections shall meet the materials requirements of AASHTO M 294.

2.9 Granular backfill shall conform to the requirements of [Section 209](#).

2.10 Cement mortar shall conform to the requirements of [Section 707](#).

2.11 Unsuitable material for bedding and backfilling pipes is either organic or one that cannot be placed to meet the required compaction or bearing capacity, with the effort normally required for this work. This definition shall only apply in cases where material properties, compaction or bearing requirements are not otherwise specified in the Contract documents.

2.12 Concrete class F, flowable fill may be requested in writing as a substitute for backfill material in accordance with [520.1.2.1.1.f](#).

## Construction Requirements

### 3.1 General.

3.1.1 Steam-cured or water-cured reinforced concrete pipe may be delivered to the project after 7 days from date of manufacture.

3.1.2 Do not lay or embed pipe in standing or running water. The Contractor shall provide for the temporary diversion of water in order to permit the installation of the culvert in a reasonably dry trench unless otherwise permitted. At all times prevent runoff and surface water from entering the trench.

## SECTION 603

**3.1.2.1** When groundwater is present in the work area, dewater to maintain stability on in-place and imported materials and maintain water level below pipe bedding and foundation. Maintain control of water in trench before, during and after pipe installation, and until embedment is installed and sufficient backfill has been placed to prevent flotation of the pipe.

**3.1.3** Figure 1 has been made a part of these specifications for clarification.

**3.1.4** Where soft or other unsuitable material is encountered, all of such unsuitable material, for the depth and width specified, shall be removed as shown in Figure 1-D.

**3.1.5** Where bedrock or other incompressible material is encountered, it shall be removed as shown in Figure 1-C.

**3.1.6** Material meeting the requirements of granular backfill or other approved material shall be used to backfill the spaces left by the excavation of material removed in accordance with 3.1.4 and 3.1.5. The material shall be uniformly compacted.

**3.1.7** The width of trenches shall be held to a minimum consistent with the space required to permit satisfactory jointing and thorough tamping of the bedding material under and around the pipe. Trenching below the top of the pipe shall be kept to a maximum of three times the diameter of the pipe. The width of the trench above the pipe may be at the Contractor's option as shown in Figure 1-B.

**3.1.7.1** For plastic pipe the minimum trench width shall be the greater of either the pipe outside diameter plus 16" or the pipe outside diameter times 1.25, plus 12".

**3.1.8** The pipe shall be placed at the designated location on a prepared foundation so that the flow line of the pipe will conform to the required grade.

**3.1.9** Where the top of the pipe would lie above the natural ground, sufficient compacted fill shall be constructed at pipe locations to ensure that the pipe is placed in a trench equal in depth to at least the height of the pipe. The fill shall be constructed on each side of the pipe for a distance equal to at least 5 times the diameter of the pipe. Refer to Figure 1-A.

**3.1.10** Sawed pavement shall conform to 628.3.4.

### 3.2 Bedding.

**3.2.1** Bedding for pipes less than 48" in diameter or span shall consist of preparing and shaping the bottom of the trench to fit the lower 10 percent of the external height of the pipe with reasonable closeness and with uniform density and stability. Recesses shall be excavated for the bells of pipe.

**3.2.2** Bedding for all pipes 48" or more in diameter or span shall consist of bedding the pipe on a carefully prepared bed of material meeting the requirements of granular backfill (sand), pre-shaped by means of a template to fit the lower part of the pipe exterior for at least 15 percent of its external height.

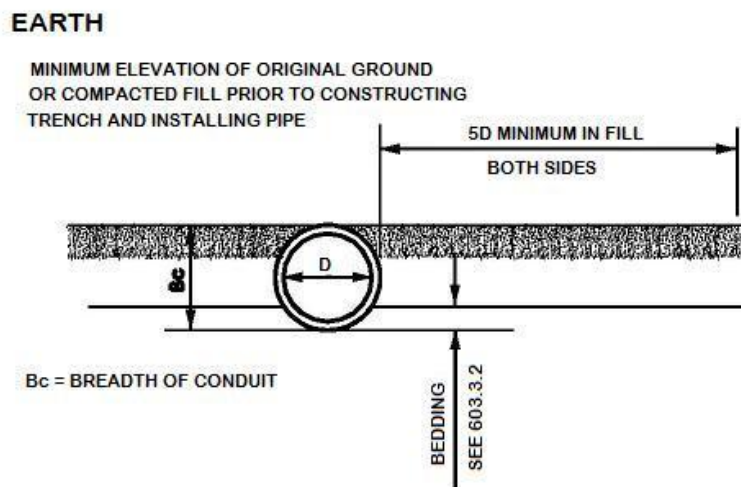

**FIGURE 1-A CULVERT DETAILS**

EARTH

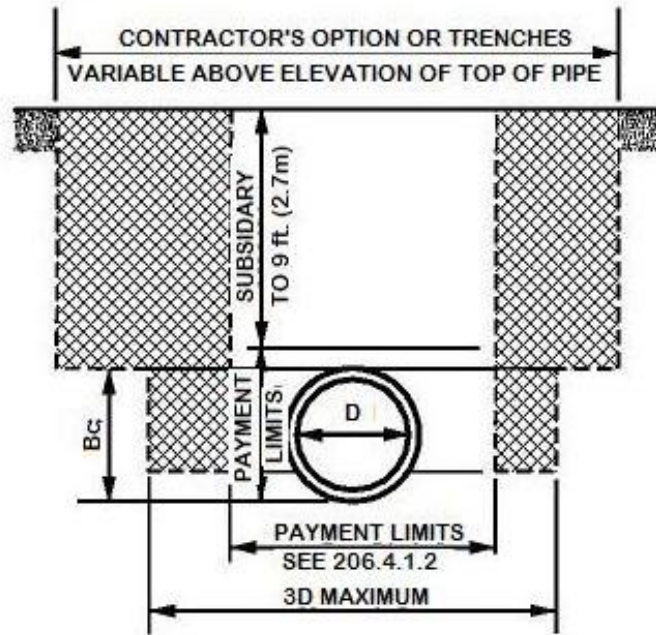

FIGURE 1-B CULVERT DETAILS

ROCK

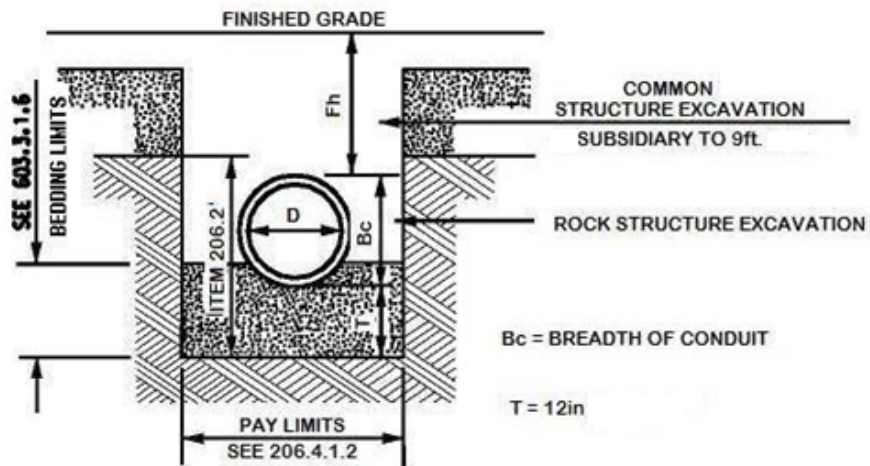

FIGURE 1-C - CULVERT DETAILS

UNSUITABLE EXCAVATION

CROSS HATCHED AREAS SHOWN  
ARE PAYMENT AREAS

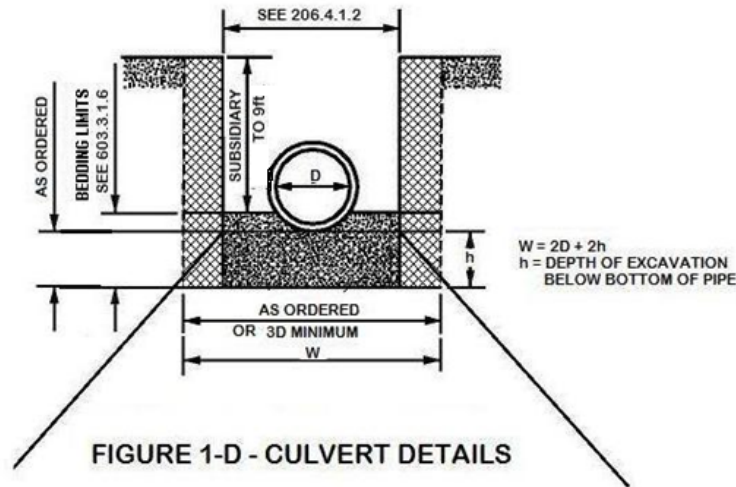

FIGURE 1-D - CULVERT DETAILS

IMPERFECT TRENCH METHOD

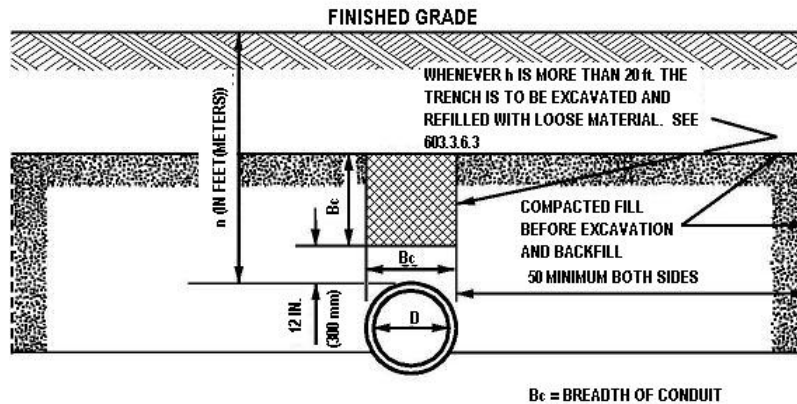

FIGURE 1-E - CULVERT DETAILS

3.3 Laying and Joining Pipe.

3.3.1 Proper facilities shall be provided for lowering the sections of pipe into the trench. Each section shall be securely attached to the adjoining section by the approved method for the type of joint used.

3.3.2 Elliptical pipe shall be so placed that major axes are within 5 degrees of the appropriate horizontal or vertical planes.

3.3.3 Joint seals for concrete pipe shall be joined in accordance with the manufacturer's recommendations.

3.3.3.1 The pipe ends shall be thoroughly cleaned before the joint is made. When it is necessary to shorten a length of reinforced concrete pipe, the pipe shall be sawed neatly using a masonry saw. The method of joining pipe sections shall be such that the ends are fully entered and the inner surfaces are reasonably flush and even.

3.3.4 Sections of corrugated metal pipe shall be joined by enclosing joints with coupling bands of the same material as the pipe unless otherwise permitted.

**3.3.5** Joints between dissimilar pipes shall be made in accordance with the recommendations of the pipe manufacturer.

**3.3.6** Surfaces of aluminum pipe or aluminized steel pipe that are to be in contact with concrete, stone, or masonry shall be thoroughly coated with an approved zinc rich primer or other approved coating, which shall be allowed to dry before the pipe is installed.

**3.3.7** Anchor bolts shall be installed as shown on the plans on steel pipes and pipe-arches 48" and higher.

**3.3.8** The pipe coupler for pipe for slope drainage shall be installed in accordance with manufacturer's recommendations.

### **3.4 End Sections.**

**3.4.1** End sections shall be installed in accordance with the recommendations of the manufacturer or as directed.

**3.4.2** Necessary excavation shall be made to the required depth and contour for the section. Where ledge is encountered, the trench shall be excavated 8" below the bottom of the end section and the area refilled to grade with suitable material, thoroughly tamped and carefully shaped.

**3.4.3** Connections between concrete end sections and pipe culverts shall be by standard tongue and groove, bell and spigot or as ordered.

### **3.5 Backfilling.**

**3.5.1** All backfill material adjacent to a pipe shall be suitable native material from the pipe excavation, or approved material. Backfill material shall be managed so that it is free from hard lumps, clods, or rocks larger than 3" diameter and free of stumps and organic material. Uniformly fine material shall be placed next to any pipe susceptible to damage.

**3.5.2** All backfill material shall be compacted at near optimum moisture content, in layers not exceeding 6" in compacted thickness, by pneumatic tampers, vibratory compactors, or other approved means. Care shall be exercised to compact the backfill thoroughly under the haunches of the pipe and to ensure that the compacted backfill material is in direct contact with the sides of the pipe. Fill at the sides of the pipe may be compacted by rolling or operating heavy equipment parallel with the culvert, provided care is taken to avoid displacement of or damage to the pipe. All backfill material shall be compacted to not less than 95 percent of AASHTO T 99, Method A.

**3.5.3** The Contractor shall place an adequate protecting cover of earth or other approved material over the structure before allowing equipment or traffic to pass over it.

**3.5.3.1** For plastic pipe the minimum cover shall be 3 ft.

### **3.6 Imperfect trench.**

**3.6.1** When the proposed fill will be 20 ft. or more above the top of the pipe, the pipe shall be bedded, installed, and backfilled as specified, and the fill carried to a height above the pipe of at least equal to the external diameter of the pipe, plus 1 ft. and thoroughly compacted in accordance with 3.5.2.

**3.6.2** A trench equal in width to the external diameter shall then be constructed in the new fill directly over the pipe down to an elevation 1 ft. above the top of the pipe as shown in Figure 1-E. Extreme care shall be exercised to keep the sides of this trench as nearly vertical as possible.

**3.6.3** This trench shall then be refilled with soil material deposited as loosely as possible. This material shall not be compacted before the embankment is constructed above it.

### **3.7 Workmanship.**

Any pipe which is not true to alignment and grade or which shows any undue settlement or deflection after laying or is damaged shall be removed and re-laid or replaced without extra compensation.

#### **3.7.1 Video Inspection.**

One hundred (100) percent of each class and type of pipe specified, up to and including 36" diameter shall be subjected to internal video inspection not less than thirty (30) days after the backfill has been placed to subgrade level unless otherwise approved by the Engineer. The pipe runs shall be cleaned and inspected for cracks, joint gaps, deformation, and other visual defects using a video camera meeting the requirements of 3.7.1.1. Flexible pipes observed to have deflection greater than five (5) percent shall be verified per 3.7.2. Any pipe found to be damaged will need to be repaired or replaced at the Contractor's expense. Any repairs will be done at the approval of the Engineer. The Engineer shall be notified as soon as practicable of any visual defects that are found and all video recordings of these areas of concern shall be made available within 24 hours. Final report shall be submitted to the Engineer within 10 days of inspection.

## SECTION 603

**3.7.1.1** The video camera shall be able to verify the quality of the pipe installation and not be limited by poor lighting, waterflow, or pipe length. The camera should have the following qualities:

- Provide its own light source or have a separate light source capable of producing images acceptable to the Engineer.
- Be able to move remotely inside the entire pipe length.
- Be able to pan and tilt to enable full view of joints.
- Have a remote monitor and a recording apparatus to view and record the condition of the installed pipe.
- The video should include identification before each section of pipe filmed. The identification should include project number, structure numbers corresponding to the structure numbers on the plans, size of pipe, date and time. The video should also be marked with distances down the pipe length with an accuracy of one foot per 100 feet.
- A copy of the video shall be provided to the Engineer on CD/DVD media in .WMV or .MPEG format. A written report accompanying the video shall also be provided to the Engineer.

**3.7.2** Deflection for flexible pipe shall not exceed 5% when measured not less than thirty (30) days following installation of backfill to subgrade level. When deflection verification is considered necessary by the Engineer, all necessary manpower and equipment, including mandrels for such tests will be provided by the Contractor in accordance with 5.7. Mandrels shall be rigid, have a minimum of nine (9) legs, be fabricated of metal and fitted with a pull ring at each end. The diameter at any point shall not be less than the allowed percent deflection of the certified actual mean diameter of the pipe being tested. The mandrel diameter should be as follows:

- The specified pipe diameter minus the inside diameter tolerance, minus the allowable deflection (5% x specified pipe diameter). The inside diameter tolerance shall be the lesser of 1.5% x specified pipe diameter or 0.5”.

**3.7.2.1** For locations where pipe deflection exceeds 5% under 3.7.2, an evaluation shall be conducted by the Contractor, utilizing a Professional Engineer, registered in the State of NH, and submitted to the Engineer for review and approval. The evaluation shall consider the severity of the deflection, structural integrity, environmental conditions, and the design service life of the pipe. Pipe remediation or replacement shall be required for locations where the evaluation finds the deflection could be problematic. For locations where the pipe deflection exceeds 7.5% of the inside diameter, remediation of the pipe or replacement is required. Pipe remediation or replacement shall be at the Contractor’s expense.

### 3.8 Special Requirements for Pipe Sleeve.

**3.8.1** When no pipe or conduit is placed in the sleeve, the ends shall be closed by suitable caps.

**3.8.2** The Contractor shall not backfill pipe sleeves until the necessary reference measurements have been made. When no pipe is placed in a non-metallic sleeve, in addition to the reference ties made by the Engineer, some means shall be provided to allow an electromagnetic current to be passed from end to end of the sleeve. The conductor shall consist of a continuous bare galvanized wire, minimum No. 9 gauge, or sections of reinforcing rod welded or otherwise permanently joined. The conductor need not be new. The conductor shall be placed in the sleeve or within 6” of the sleeve.

**3.8.3** When the sleeve is to be installed by boring or drilling, the pavement shall not be disturbed. Suitable pits or trenches shall be excavated for the purpose of conducting the boring operations and for welding end joints of the pipe. Such pits shall be kept at least 2 ft. clear of the edge of the pavement and necessary precautions taken to prevent caving.

**3.8.3.1** Variation in the final position of the pipe from the established line and grade shall not exceed 0.1 of a foot per 10 feet.

**3.8.3.2** Jetting will not be permitted.

**3.8.3.3** When permitted, a method employing water may be used provided it can be demonstrated and guaranteed that the water forced through the inserted washing pipe will be used to wash out only the material trapped within the body of the pipe, and all the water will be returned through the pipe.

**3.8.3.4** When the pilot hole method is employed, the holes are to be bored mechanically. The boring may be done using a pilot hole approximately 2” in diameter bored the entire length of the crossing. This shall be checked for line and grade. If satisfactory, this hole shall serve as the center line of the larger diameter hole to be bored. Under this method, the use of water or other fluids in connection with the boring operation will be permitted only to the extent necessary to lubricate cuttings.

**3.8.3.5** If the Contractor desires to employ a method different from the above suggested methods, he shall furnish the details for approval.

**3.8.3.6** After the pipe has been placed, boring operation trenches or pits shall be backfilled in layers not greater than 8” compacted depth, with each layer thoroughly compacted. Any surplus material shall be disposed of as required.



### 3.9 Removal of Pipe for Relaying.

- 3.9.1 Pipes shall be removed in accordance with 202.3.3 and 107.09.
- 3.9.2 Any pipe damaged shall be replaced with like material.
- 3.9.3 Any additional pipe needed shall be of like material.

### 3.10 Pipe Bored or Jacked.

3.10.1 When pipe other than pipe sleeve is to be bored or jacked, specifications governing the materials and construction requirements will be provided in the proposal.

#### Method of Measurement

4.1 Pipe will be measured by the linear foot to the nearest foot. Measurement of circular pipe will be made between the ends of the pipe along the central axis, including through elbows and bends, as installed. In the case of pipe-arches, the length will be measured along the invert. In the case of twin pipes and other multiple pipe structures, each barrel will be measured separately.

4.1.1 No separate measurement will be made for elbows or bends.

4.2 End sections will be measured by the number of units installed.

4.3 Video inspection will be measured by the linear foot to the nearest foot based on the actual measured length of pipe per 4.1.

#### Basis of Payment

5.1 The accepted quantities of pipe will be paid for at the Contract unit price per linear foot of the kind, type, and size specified complete in place, including sawed pavement, common structure excavation up to the depth specified in 206.4.1, secondary excavation required in the imperfect trench method, bedding, pre-shaping of bedding, and backfill, with the following stipulations:

5.1.1 All rock structure excavation, any common structure excavation below the depth specified in 206.4.1, and excavation of unsuitable material required below the bottom of the pipe, will be paid as provided in Section 206. Bottom of pipe is defined in 5.1.1.1.

5.1.1.1 The term “bottom of pipe” for concrete pipe shall mean the nominal manufactured thickness of the wall below the flow line, with nothing extra for bells of bell and spigot pipe; such term when used with metal pipe shall be considered to be the same elevation as the flow line.

5.1.2 When the depth of excavation for a pipe is increased more than 1 ft. by lowering the grade or changing the location from that shown on the plans, or when pipes are ordered in addition to those shown on the plans, additional excavation will be paid as provided in Section 206 in accordance with 206.4.1.1.

5.1.3 Granular backfill, when specified or ordered, will be paid as provided in Section 209.

5.2 End sections of the kind and size specified will be paid for at the Contract unit price each complete in place.

5.3 The accepted quantities of video inspection will be paid for at the Contract unit price per linear foot and will include all required labor, equipment and materials.

5.4 The cost of furnishing and installing additional pipe for laying or relaying pipe, required through no fault of the Contractor, will be paid as provided in 109.04 unless a bid item therefore is included in the Contract.

5.5 When pipe is bored or jacked, no extra allowance will be made for excavation or backfill for the pipe or for any jacking pits. Any damage to the existing roadway shall be repaired at the Contractor's expense.

5.6 Temporary diversion of water including trenching or pumping directly from the trench or sumps shall be subsidiary to the culvert installation. Unless otherwise provided for by separate item, well points or other specific dewatering devices required or ordered will be paid as shown or as provided in 109.04.

5.7 When deflection verification testing is ordered by the Engineer, all costs associated with this testing will be paid by the Contractor, unless the deflection is 5 percent or less for a complete run of pipe. When deflection is 5 percent or less, the Contractor will be reimbursed for all costs associated with the testing, as provided for in 109.04, for all continuous runs of pipe found to be acceptable.

5.8 All backfill, above the bedding limits including concrete class F, flowable fill substituted for backfill material shall be subsidiary to the pipe item.

5.8.1 If suitable backfill is not available within the project limits the Engineer may order material meeting the requirements as defined under 3.5 and paid for as Item 203.6.

**SECTION 603**

**KEY TO ITEM NUMBERS FOR PIPES**

Item Number	Unit
603.0001          Video Inspection	Linear Foot
603 .A B C D E          Item Number	
.A                  Material or Use	
B                  Type of Material	
C                  Class, Thickness, or Other	
D E          Diameter or span rounded to nearest inch	
.0 Reinforced Concrete Pipes	Linear Foot
B Type	
0 Circular	
1 Arch	
2 Blank	
3 Blank	
4 Blank	
C Class	
1 1500 D	
2 2000 D	
3 3000 D	
4 3750 D	
.1 Metal Pipes	Linear Foot
B Material	
1 Corrugated Galvanized Steel	
2 Blank	
3 Corrugated Aluminized Steel (Type 2)	
4 Blank	
5 Corrugated Steel Pipe-Arch	
6 Blank	
8 Corrugated Steel Slotted Drain Pipe	
C Steel Thickness in Inches	
0 0.064	
2 0.079	
4 0.109	
6 0.138	
8 0.168	
.2 Pipe Sleeves	Linear Foot
B Material	
0 Unspecified	
1 Reinforced Concrete	
C Class of Reinforced Concrete	
1 1500 D	
2 2000 D	
3 3000 D	
4 3750 D	
2 Corrugated Steel	
3 Blank	
4 Plastic	
C Type	
0 Unspecified	

	1 PVC	
	2 Polyethylene	
.3	End Sections	Each
	B Material	
	0 Reinforced Concrete	
	C Class of Reinforced Concrete	
	1 1500 D	
	2 2000 D	
	3 3000 D	
	4 3750 D	
	1 Blank	
	2 Blank	
	3 Plastic	
	C Type	
	1 Blank	
	2 Polyethylene	
	3 Blank	
	4 Steel	
	5 Blank	
	6 Aluminized Steel	
	C Steel Thickness in Inches	
	1 0.064	
	2 0.079	
	4 0.109	
	6 0.138	
	8 0.168	
	9 Resetting _____ End Section	
	C Material	
	0 Unspecified	
	1 Reinforced Concrete	
	2 Corrugated Steel	
	3 Blank	
	4 Plastic	
.4	Pipe for Slope Drainage	Linear Foot
	B Material	
	0 Unspecified	
	1 Blank	
	2 Blank	
	3 Blank	
	4 Plastic	
	C Type	
	0 Blank	
	1 Blank	
	2 Polyethylene (Type C)	
.5	Pipe for Drives and Minor Approaches	Linear Foot
.6	Laying or Relaying Drainage Pipe (Furnished by the State or Salvaged)	Linear Foot
	B Material	
	0 Unspecified	
	1 Reinforced Concrete	
	2 Blank	
	3 Blank	
	4 Plastic	

**SECTION 603**

.7	Pipe, Jacked or Bored	Linear Foot
	B Materials/Use	
	1 Reinforced Concrete under Roadbed	
	2 Reinforced Concrete under Railroad	
	C Class	
	1 1500 D	
	2 2000 D	
	3 3000 D	
	4 3750 D	
	3 Blank	
	4 Blank	
.8	Plastic Pipe	Linear Foot
	B Materials	
	0 Unspecified	
	1 PVC	
	2 Polyethylene	
	3 Blank	
	C Type	
	1 Corrugated Interior (Type C)	
	2 Smooth Interior, Double Wall (Type S)	
	3 Smooth Interior, Triple Wall (Type D)	
	4 Blank	
	5 Corrugated Interior (Type C) (Watertight)	
	6 Smooth Interior, Double Wall (Type S) (Watertight)	
	7 Smooth Interior, Triple Wall (Type D) (Watertight)	
.9	Drainage Pipe (Contractor's Option – Concrete or Plastic)	Linear Foot
	B Materials	
	0 Unspecified	
	C Type	
	0 Blank	
	1 Blank	
	2 Smooth Interior, Double Wall (Type S)	
	3 Smooth Interior, Triple Wall (Type D)	
	4 Blank	
	5 Blank	
	6 Smooth Interior, Double Wall (Type S) (Watertight)	
	7 Smooth Interior, Triple Wall (Type D) (Watertight)	

**Examples:**

603.00215	15" Reinforced Concrete Pipe, 2000 D	Linear Foot
603.20004	4" Pipe Sleeve	Linear Foot
603.332__	__" Polyethylene End Section	Each
603.40012	12" Pipe for Slope Drainage	Linear Foot
603.44212	12" Polyethylene Pipe for Slope Drainage	Linear Foot
603.6	Relaying 0-24" Drainage Pipe	Linear Foot
603.60030	Relaying 30" Drainage Pipe	Linear Foot
603.821__	__" Polyethylene Pipe (Corrugated Interior)	Linear Foot
603.802__	__" Plastic Pipe (Smooth Interior)	Linear Foot
603.900__	__" Drainage Pipe	Linear Foot

**SECTION 604 -- CATCH BASINS, DROP INLETS, AND MANHOLES****Description**

- 1.1** This work shall consist of furnishing and constructing catch basins, drop inlets, and manholes; with frames, grates or manhole covers, as shown on the plans or as ordered. Sawed pavement, common structure excavation to the depth specified in 206.4.1, bedding if required, and backfill shall be included in this work.
- 1.2** This work shall consist of reconstructing, including adjusting, existing catch basins, drop inlets, and manholes as shown on the plans or as ordered.
- 1.3** This work shall also consist of furnishing and installing frames, grates or manhole covers, as shown on the plans or as ordered.

**Materials**

- 2.1** Precast concrete sections shall conform to AASHTO M 199. The concrete shall be Class AA, meeting the requirements of [Section 520](#) except as noted herein.
- 2.2** Reinforcing shall be steel, or structural fibers. Steel shall conform to the requirements of [Section 544](#). Fibers shall only be utilized in structures with 4 ft. or less inside diameter and shall be as listed on the [Qualified Products List](#).
- 2.3** Precast concrete sections shall conform to AASHTO M 199. The concrete shall be Class AA, meeting the requirements of [Section 520](#) except as noted herein.
- 2.3.1** Except for components cast using the dry cast process, precast concrete components shall not have the forms removed until a minimum compressive strength of 2000 psi has been achieved. Once initial set of the concrete has occurred, precast components shall not be moved until a minimum compressive strength of 2000 psi has been achieved. Concrete cylinders shall be made, in accordance with AASHTO T 23, at the last placement of the day.

**2.3.2 Curing of precast sections.**

**2.3.2.1** All precast concrete units shall be coated with a white pigmented curing compound before being stored outside. The membrane curing compounds used under this method shall be Type 2 (white pigmented) Class B conforming to AASHTO M 148 and must appear on the [Qualified Products List](#), Section 520. The compound shall be properly agitated immediately before each use. A minimum coverage rate of 1 gallon per 200 square feet shall be used.

**2.3.2.1.1** Where concrete is to be bonded with fresh concrete or coatings applied, curing compound shall be removed.

**2.3.2.2** Prior to placement of the curing compound, all precast concrete units shall be subjected to curing by any one of the methods described below. The manufacturer shall provide minimum/maximum temperature thermometers to monitor curing temperatures unless otherwise specified. If, at any time, curing temperatures fall below the specified minimum for the chosen curing method, the curing period shall be increased accordingly. No unit shall be subjected to freezing temperatures until eighty percent of the specified 28 day compressive strength has been reached.

**2.3.2.3** Units which are exposed to freezing before reaching the required 28 day compressive strength may require additional testing for compressive strength, as directed by the Materials and Research Bureau. Additional testing, when required, will be performed on cores taken from the hardened concrete.

**2.3.2.4 Steam Curing.** The units shall be cured in a suitable enclosure as approved by the Bureau of Materials and Research. The enclosure shall be designed to minimize the loss of heat and moisture while allowing for the uniform circulation of steam around the entire unit. The interior surfaces of the enclosure and the surface of the unit shall be moist at all times. Steps shall be taken to prevent localized “hot spots” caused by the steam lines. The enclosure shall be free from outside drafts.

**2.3.2.4.1** Steam curing shall not begin until a preset period has been completed. The preset period begins when the last concrete has been placed and continues until the concrete obtains initial set. Prior written approval from the Bureau of Materials and Research is required when preset periods of less than two hours are to be used.

**2.3.2.4.2** During the preset period, moderate heat may be applied to the enclosure to maintain the initial temperature of the concrete. The maximum temperature inside the enclosure during the preset period shall be the initial temperature of the concrete, plus 9° F.

**2.3.2.4.3** After the preset period is complete, steam shall be injected into the curing enclosure. The temperature inside the enclosure shall not be increased at a rate greater than 36 F° per hour. A moist atmosphere will be maintained at a temperature between 104 F° and 185 F° for a period of not less than 12 hours. The temperature inside the enclosure shall then be decreased at a rate not exceeding 36 F° per hour until the ambient temperature outside the enclosure is reached. The manufacturer shall provide automatic temperature recorders to continuously record the curing temperature inside the enclosure. The concrete strength shall be determined by testing cylinders cured in the same environment as the concrete they represent.

## SECTION 604

**2.3.2.5 Water Spray Curing.** Curing shall begin as soon as the concrete has hardened sufficiently to prevent surface damage from the water spray. All exposed surfaces of the precast unit shall be kept wet with a continuous fine spray of water in an enclosure maintained at a temperature of not less than 68 F° for 72 hours or until 80% of the 28 day compressive strength is reached. The concrete strength shall be determined by testing cylinders cured using the water spray method and kept in the same environment as the concrete they represent.

**2.3.2.6 Saturated Cover Curing.** The saturated covers used under this method shall be burlap, meeting the requirements of 520.2.6.1. Curing shall begin as soon as the concrete has hardened sufficiently to prevent surface damage from the saturated burlap. All exposed concrete surfaces on the precast unit shall be covered with burlap, saturated with water before applying. The burlap will be kept saturated and the units kept at a temperature of not less than 68 degrees F for 72 hours or until 80% of the 28 day compressive strength is reached. The concrete strength shall be determined by testing cylinders cured using the saturated cover method and kept in the same environment as the concrete they represent. Additional curing time may be necessary to meet the strength requirements.

**2.3.2.7 Moisture Retention Curing.** Units cured in accordance with these methods shall be maintained at a minimum temperature of 50 ° F for 7 days or until 80% of the 28 day compressive strength has been reached. Additional curing time may be necessary to meet the strength requirements. The concrete strength shall be determined by testing cylinders cured in the same environment as the concrete they represent. Moisture retention curing shall be accomplished by either of the following 2 methods.

### **2.3.2.7.1 Membrane Curing Compound.**

**2.3.2.7.1.1** The membrane curing compound shall be applied to the concrete surface after finishing, as soon as the free water on the surface has disappeared and no water sheen is visible, but not so late that the liquid curing compound will be absorbed into the concrete. When curing compound cannot be applied within the above requirements, the manufacturer shall instead immediately begin curing the unit in accordance with one of the other curing methods contained in this specification, until curing compound can be applied. When curing compound is to be used in conjunction with any other method of cure, the Engineer shall be notified prior to the start of production. When this method is used in conjunction with the dry cast process, the curing room shall be kept at 100% humidity until a minimum compressive strength of 2000 psi has been obtained.

**2.3.2.7.1.2** When the forms are removed prior to 7 days, the exposed concrete surfaces shall be wet with water within one half hour of form removal and shall be kept wet until the curing compound is applied. Before application, the concrete shall be allowed to reach a uniformly damp appearance with no free water on the surface, and then the compound shall be applied immediately.

**2.3.2.7.1.3** This method of curing shall not be used on any concrete surface that is to have plastic concrete bonded to it. Another approved method of curing shall be used when this condition exists.

### **2.3.2.7.2 Curing Covers.**

**2.3.2.7.2.1** The curing covers used under this method shall conform to AASHTO M 171. Curing covers shall be placed immediately following the finishing operation or form removal, whichever is applicable. Care shall be taken not to damage any exposed concrete surfaces during cover placement. Curing covers shall be placed and secured and be of such condition as to minimize the loss of moisture and temperature. When it is necessary to use more than one curing cover, the edges shall be lapped a minimum of 12”.

**2.4** Clay brick shall conform to the requirements of AASHTO M 91, Grade MS. The use of concrete brick will not be permitted.

**2.5** Concrete masonry units shall conform to the requirements of ASTM C 139 and shall have a minimum compressive strength of 3,000 psi when tested by the method in AASHTO T 140.

**2.6** Cement mortar shall conform to [Section 707](#).

**2.7** Castings shall be gray iron conforming to AASHTO M 306. Castings shall be proof load tested.

**2.8** Steel grates shall be of structural steel conforming to AASHTO M 183M ASTM A 36/A 36M. The grates shall be fabricated as shown on the plans or approved. All top edges shall be flush, and all rivets shall be tight and properly headed. After fabrication, the grates shall be galvanized in accordance with AASHTO M 111 or ASTM A 153 as applicable.

**2.9** Prefabricated adjustment rings for catch basins, drop inlets and manholes shall conform with 2.7 or as approved by the Engineer.

**2.10** Polyethylene liner material shall conform to the requirements of AASHTO M 294, Section 6.0, but not have a wall thickness less than 1/4”.

### Construction Requirements

**3.1** Concrete construction shall conform to the requirements for structural concrete. Masonry shall conform to the requirements for the respective type. Joints shall be full mortar joints not more than 1/2" wide. Exposed joints shall be neatly finished. Masonry shall fit neatly and tightly around the pipe.

**3.1.1** Reinforced precast sections shall not be shipped from the manufacturing facility until the eighth day from the date of manufacture, except when the supplier provides test results demonstrating that the design strength has been achieved.

**3.1.2** Special structures shall be as shown in the plans.

**3.2** In accordance with the provisions of AASHTO M 105, 17.2, following are the "other matters of workmanship and finish" required: Frames and grates or frames and covers shall be matched before being incorporated in the work. Grates and covers shall make full and even bearing on the underlying surface to fit into the frames without rocking.

**3.3** When reconstruction or adjustment of existing structures is specified, the frames and grates or covers shall be removed and the walls reconstructed as required. The frames and grates or covers shall be cleaned and reset at the required elevation.

**3.3.1** Prefabricated adjustment rings may be used and shall be installed in accordance with the manufacturer's recommendations.

**3.4** Structures within the limits of bituminous concrete pavement shall be temporarily set at the elevation of the bottom of the binder course or as ordered. After the binder course has been compacted, these structures shall be set at their final grade. Backfill necessary around such structures after the binder course has been completed shall be made with Class AA concrete unless otherwise ordered.

**3.5** Upon completion, each structure shall be cleaned of silt debris, or other matter of any kind and shall be kept clean until Acceptance of the Work.

**3.6** Excavation and backfill shall conform to [206.3](#). Sawed pavement shall conform to [628.3.4](#).

**3.7** Sewer manholes constructed or reconstructed shall be tested after all connections have been made according to the requirements of the Department of Environmental Services, Water Division.

**3.8** Surface preparation for drainage structures to be treated with water repellent shall be sufficient to remove dust, dirt, oil, wax, other coatings, efflorescence and other foreign materials. All surfaces shall be dry prior to the application of water repellent.

**3.8.1** Treatment shall be performed in accordance with the other applicable provisions of [Section 534](#).

**3.9** Polyethylene liners shall be manufactured and installed in accordance with the [NHDOT Standard Plans](#).

### Method of Measurement

**4.1** Catch basins, drop inlets, and manholes will be measured from the bottom of the metal frame or concrete cover to the inside bottom top of the base.

**4.2** Reconstructing/adjusting catch basins, drop inlets, or manholes will be measured by the linear foot, vertically to the nearest 0.1 of a foot, between the bottom of the metal frame or concrete top and the top of the undisturbed portion of the existing structure.

**4.3** Frames with grates or manhole covers together be a will unit and will be measured by the number of each unit installed, except when they are a part of a structure measured under 4.1.

**4.4** Polyethylene liners will be measured by number of each installed.

### Basis of Payment

**5.1** The accepted quantities of catch basins, drop inlets, and manholes, which includes the necessary frames and grates or covers, of the type and diameter specified will be paid for at the Contract unit price per unit complete in place, including sawed pavement, common structure excavation and setting to final grade to the depth specified in [206.4.1](#), bedding if required and backfill with the following stipulations:

**5.1.1** For catch basins and manholes other than special catch basins and manholes, up to the first 8 ft. will be paid for as one unit. Any additional depth required will be paid by dividing the additional depth by the 8 ft. unit depth. Payment will be to the nearest tenth of a unit.

**5.1.2** For drop inlets other than special drop inlets, up to the first 5 ft. will be paid for as one unit. Any additional depth required will be paid by dividing the additional depth by the 5 ft. unit depth. Payment will be to the nearest tenth of a unit.

**5.1.3** Payment for structures indicated as "special" will be made by the complete unit of the depth shown on the plans. When an increase of 6" or greater is ordered from the depth shown, the unit depth will be adjusted in proportion that the constructed

**SECTION 604**

depth, measured to the nearest foot, bears to the depth shown on the plans. The proportion will be computed to no more than 2 decimal places.

**5.1.4** All rock structure excavation, any common structure excavation below the depth specified in 206.4.1 and excavation of unsuitable material below the bottom of the catch basin, drop inlet, and manhole will be paid as provided in Section 206. Over excavation for bedding purposes in ledge and backfill for said over excavation will be subsidiary.

**5.1.5** No extra allowance will be made for structures constructed in accordance with 3.4.

**5.1.6** Water repellent treatment for new drainage structures will be subsidiary.

**5.2** The accepted quantities of reconstructed/adjusted catch basins, drop inlets, and manholes will be paid for at the Contract unit price per linear foot complete in place, including reinstalling existing frames and grates or covers. A minimum of 1 foot of reconstructing/adjusting will be paid for each structure measured.

**5.2.1** No payment will be made for reconstructing/adjusting portions of the above structures which are unnecessarily disturbed.

**5.2.2** No separate payment will be made for excavation for reconstructing/adjusting the above structures.

**5.3** The accepted quantities of frames and grates or manhole covers will be paid for at the Contract unit price per each unit complete in place, including setting to final grade.

**5.4** Testing of sewer manholes required in 3.7 will be subsidiary.

**5.5** The accepted quantities of polyethylene liner will be paid at the Contract unit price per each installed complete in place.

**Pay items and units:**

604.0007 Polyethylene Liner Each

**KEY TO ITEM NUMBERS FOR CATCH BASINS, DROP INLETS AND MANHOLES**

Item NumberUnit

604	.A	B	C	Item Number
604				Section Number
	.A			Structure Type
		B		Grate and Frame Type
			C	Diameter

.1	Catch Basins Type __, __ ft. Diameter	Unit
1	Blank	
2	Type B	
3	Type C	
4	Blank	
5	Type E	
6	Type F	
8	With Frames and Grates Furnished by Others	
9	Special	

.2	Drop Inlets Type __, __ ft. Diameter	Unit
1	Blank	
2	Type B	
3	Type C	
4	Type D-	
5	Type E	
6	Type F	
8	With Frames and Grates Furnished by Others	
9	Special	



.24	Drop Inlets D-___	Unit
1	Blank	
2	Type B	
3	Blank	
4	Blank	
5	Type E	
6	Type F	
.3	Manholes	Unit
1	Sewer Manholes, ___ ft. Diameter	
2	Drainage Manholes, ___ ft. Diameter	
9	Special	
.4	Reconstructing/Adjusting Catch Basins and Drop Inlets	Linear Foot
.5	Reconstructing/Adjusting ___ Manholes	Linear Foot
1	Sewer	
2	Drainage	
3	Electrical	
4	Telephone	
.6	___ Manhole Covers and Frames	Each
1	Sewer	
2	Drainage	
.7	Grates and Frames, Type ___	Each
1	Blank	
2	Type B	
3	Type C	
4	Blank	
5	Type E	
6	Type F	

**Examples:**

- 604.126 Catch Basin Type B, 6 ft. Diameter
- 604.226 Drop Inlet Type B, 6 ft. Diameter
- 604.242 Drop Inlet Type D-B
- 604.326 Drainage Manholes, 6 ft. Diameter
- 604.51 Reconstructing/Adjusting Sewer Manholes

## SECTION 605

### SECTION 605 -- UNDERDRAINS

#### Description

**1.1** This work shall consist of furnishing (unless pipe is provided) and installing underdrains at the locations shown or ordered. Pipe, common structure excavation, support membrane, graded aggregate, sand cushion, and backfill where specified shall be included in this work.

**1.1.1** Furnishing and installing underdrain flushing basins as shown on the plans or ordered shall also be included in this work.

**1.2** Aggregate underdrain shall consist of furnishing and installing support membrane, graded aggregate, pipe, if ordered, common structure excavation, and backfill as necessary.

#### Materials

**2.1** Perforated corrugated steel pipe and coupling bands shall conform to the applicable requirements of AASHTO M 36, Type III. The minimum allowable metal thickness of 6" underdrain pipe shall be 0.052"; the minimum allowable metal thickness in underdrain pipe larger than 6" shall be 0.064".

**2.2** Perforated corrugated aluminum pipe and coupling bands shall conform to the applicable requirements of AASHTO M 197.

#### **2.3 Polyvinyl Chloride (PVC).**

**2.3.1** Manufacturers of Polyvinyl Chloride (PVC) pipe must participate in and maintain compliance with, the AASHTO "National Transportation Product Evaluation Program" (NTPEP) that audits producers of plastic pipe. A certificate of compliance, as required by 106.04, shall be provided for each shipment.

**2.3.2** Smooth-wall perforated and un-perforated polyvinyl chloride pipe, bends and cleanouts shall conform to AASHTO M 278. Perforated polyvinyl chloride profile wall pipe shall conform to AASHTO M 304.

**2.3.3** Basis of acceptance and test requirements of polyvinyl chloride pipe shall conform to AASHTO M 278 or AASHTO M 304 for the respective type of pipe.

#### **2.4 Polyethylene.**

**2.4.1** Manufacturers of polyethylene pipe must participate in and maintain compliance with, the AASHTO National Transportation Product Evaluation Program ([www.ntpep.org](http://www.ntpep.org)) that audits producers of polyethylene pipe a Certificate of Compliance as required by 106.04 shall be provided for each shipment.

**2.4.2** Polyethylene drainage tubing 6" in diameter shall conform to AASHTO M 252, Type S, with either Class 1 or Class 2 perforations. Perforated corrugated polyethylene pipe of nominal sizes 12 to 36" diameter shall conform to AASHTO M 294, with Class 1 perforations. Lengths for all sizes shall not exceed 20 ft.

**2.4.3** Basis of acceptance and test requirements of polyethylene pipe shall conform to AASHTO M 252 or AASHTO M 294 for the respective type of pipe. The approval criteria can be obtained from the Bureau of Materials and Research. A certificate of compliance, as required by 106.04, shall be provided for each shipment.

#### **2.5 Pipe Underdrain, Materials Per Contractor's Option.**

**2.5.1** When the item reads 6" pipe underdrain (Contractor's option), it shall be the Contractor's option whether he furnishes perforated corrugated steel pipe, perforated corrugated aluminum pipe, perforated polyvinyl chloride pipe or perforated corrugated polyethylene drainage tubing.

**2.6** Sand cushion shall be so graded that 90 to 100 percent by weight will pass a 1/2" sieve, and not more than 12 percent will pass a No. 200 sieve.

**2.7** Underdrain backfill shall meet the requirements of 209.2.1.

**2.8** Molded pull boxes for underdrain flushing basins shall conform to 614.2.6.

**2.9** Aggregate for aggregate underdrain shall conform to Table 703-1, Standard Size #4.

**2.10** Support membrane shall be non-woven geotextile and conform to Item 593.131 - Geotextile, Subsurface Drainage, Class 3, Non-woven.

#### Construction Requirements

**3.1** Trenches shall be excavated to the dimensions and grade shown or ordered. A minimum 2" sand cushion in common excavation and a 6" sand cushion in rock excavation shall be placed in the bottom of the trench for its full width and length to the grade of the bottom of the pipe.

**3.2** Perforated pipe shall normally be placed with the perforations down, and sections shall be securely joined with the appropriate couplings, fittings, or bands.

**3.3** After the pipe installation has been inspected and approved, underdrain backfill material shall be placed to a height of 12" above the top of the pipe, care being taken not to displace the pipe. The remainder of the backfill material shall then be placed to the required height and compacted in lifts not to exceed 12".

**3.4** Pipes shall be laid with 45-degree bends where changes in direction are indicated on the plans.

**3.5** Except at structures, upgrade ends of all underdrain pipe installations shall be closed with suitable plugs to prevent entry of soil material.

### **3.6 Flushing Basins.**

**3.6.1** Flushing basins shall be installed approximately 2 ft. beyond the break in the shoulder and in such manner as to allow the molded pull box to be set within the slope limits.

**3.6.2** Any excavation required to install flushing basins shall be done in accordance with 3.1.

**3.6.3** Additional 6" un-perforated pipe shall be added to the long 1/8 bend to bring the riser to the required elevation.

**3.6.4** After the fitting and 6" riser pipe installation has been inspected and approved, underdrain backfill material shall be placed and properly compacted to a height which will allow for the proper installation of the cleanout and molded pull box. The remainder of the backfill and base course necessary shall then be placed to the required height and compacted. Care shall be taken to prevent backfill material from entering the riser pipes.

### **3.7 Aggregate Underdrains.**

**3.7.1** Trenches shall be excavated to the dimensions shown or ordered. Type 1 aggregate underdrain shall have a 6" by 10 foot section of pipe at the outlet end of each section of underdrain. Type 2 shall include pipe of the specified diameter throughout.

**3.7.2** Non-woven support membrane shall be installed so as to minimize the number of fabric seams within the trench section. Seams shall be constructed by overlapping the fabric at least 12" and folding to create a joint which will ensure that soil infiltration will be retarded.

**3.7.3** Aggregate shall be placed within the typical section as shown in a manner that will maintain the fabric integrity. Punctures created by aggregate, equipment, tools or improper handling shall be patched by placing fabric at least 12" beyond the puncture limits on the outside of the typical section.

**3.7.4** Pipe, as required, shall be laid to grade as ordered.

**3.7.5** Backfill shall be placed and tamped in the areas outside and adjacent to the aggregate underdrain so that the shape of the typical is maintained. Sharp pieces of rock shall not be placed immediately adjacent to the fabric.

**3.7.6** When rock is encountered, sharp projections of solid rock shall be removed within the typical section, primarily at the bottom of the trench.

**3.8 Workmanship.** Underdrain 12" and above that is also utilized as part of a drainage run shall be video inspected in accordance with 603.3.7.

#### **Method of Measurement**

**4.1** Underdrains will be measured by the linear foot to the nearest 0.1 foot along the centerline of the pipe.

**4.1.1** Aggregate underdrain will be measured by the linear foot, to the nearest 0.1 of a foot along the centerline of the aggregate underdrain.

**4.2** Backfill or cushioning material furnished will be subsidiary.

**4.3** Underdrain flushing basins will be measured by the number of units installed.

**4.3.1** Each unit shall include all required riser pipe, 45° wye, long bend, cross pipe, cleanout pull box and backfill material as required.

**4.4** Video inspection required under 3.8 will be measured in accordance with 603.4.

#### **Basis of Payment**

**5.1** The accepted quantities of underdrain of the type specified will be paid for at the Contract unit price per linear foot in place, including common structure excavation, sand cushion and backfill.

**5.1.1** Payment will not be made for 45 degree bends.

## SECTION 605

5.1.2 Rock excavation will be paid for under Item 206.2.

5.2 The accepted quantity of underdrain flushing basins will be paid for at the Contract unit price per each complete in place, including riser pipe, 45° wye, long bend, cross pipe, cleanout pull box, common structure excavation, and backfill.

5.3 The accepted quantities of aggregate underdrain of the type specified will be paid for at the Contract unit price per linear foot in place, including support membrane, graded aggregate, pipe, if ordered, common structure excavation, and backfill.

5.3.1 Payment will not be made for fabric used for patching.

5.3.2 Rock excavation required will be paid for as provided in 5.1.2.

5.4 Video inspection required under 3.8 will be paid for as provided for in 603.5.

### Pay items and units:

605.1_	_in Perforated Corrugated Steel Pipe Underdrain	Linear Foot
605.4_	_in Perforated Polyvinyl Chloride Pipe Underdrain	Linear Foot
605.5_	_in Perforated Corrugated Polyethylene Pipe Underdrain	Linear Foot
605.79	Underdrain Flushing Basins	Each
605.81A	_in Aggregate Underdrain Type 1	Linear Foot
605.82ABC	_in Aggregate Underdrain Type 2, With _____ Pipe	Linear Foot
605.84015	1-1/2" PVC Plastic Horizontal Drains	Linear Foot
605.906	6" Pipe Underdrain (Contractor's Option)	Linear Foot

### Notes:

#### A = Width of Underdrain

1 = 18" 2 = 24" 3 = 30" 4 = 36" 5 = 48" 6 = 16"

#### B = Type of Material

- 1 = Perforated Corrugated Steel
- 2 = Blank
- 3 = Perforated Corrugated Aluminum
- 4 = Perforated Polyvinyl Chloride
- 5 = Perforated Corrugated Polyethylene

#### C = Diameter of Pipe

1 = 6" 2 = 12" 3 = 18" 4 = 24" 5 = 4" 8 = 8"

### Examples:

605.82311	30" Aggregate Underdrain Type 2, with Perforated Corrugated Steel 6" Pipe	Linear Foot
605.906	6" Pipe Underdrain. (Contractor's Option)	Linear Foot

**SECTION 606 -- GUARDRAIL****Description**

**1.1** This work shall consist of furnishing and installing guardrail, anchorages, terminal units, concrete barriers, and pipe handrails of the type specified at the locations shown on the plans or as ordered.

**1.1.1** Resetting of existing guardrail shall be included in this work.

**1.1.2** Temporary guardrail, temporary concrete barrier, and temporary impact attenuators shall consist of furnishing, installing, maintaining, relocating and removing as specified.

**1.1.3** Any excavation required for this work is subsidiary to the item except as provided for in 606.5.8

**Materials****2.1 Wood Posts, Offset Blocks, and Rails.**

**2.1.1** Wood posts shall be treated in accordance with 2.2, sound and reasonably straight. The ends shall be cut square or as indicated. Posts with hollow knots, open or plugged holes, or season checks exceeding 1/4" in width will be rejected.

**2.1.1.1** Guardrail posts, offset blocks and wood rails shall be made of timber with a stress grade of 1,200 psi or more for extreme fiber in bending in accordance with AASHTO M 168. All cuts and holes shall be made before preservative treatment.

**2.1.1.2** Wood rails shall be treated in accordance with 2.2, straight and sound, free from loose knots and other defects, and shall be surfaced on all sides.

**2.1.2** Synthetic offset blocks for guardrail shall be a product as listed on the [Qualified Products List](#). They shall be made of synthetic materials, recycled preferred and shall meet the criteria of NCHRP 350 Test Level 3.

**2.2 Preservative Treatment.**

**2.2.1** All wood posts, blocks and rails shall be treated with preservative materials conforming to the requirements of AASHTO M 133.

**2.2.2** The type of treatment shall be one of the following:

Treatment	Minimum net retention, Pounds per cubic foot
Type A Pentachlorophenol	0.60 Dry Salts
Water-Borne Preservative	0.40

**2.2.3** All wood posts and rails shall be treated after sawing and drilling or retreated after drilling in accordance with AASHTO M 133.

**2.3 Structural Shape Posts.**

**2.3.1** Structural shape steel posts shall conform to ASTM A 36 and shall be galvanized after fabrication to meet the requirements of AASHTO M 111.

**2.3.2** Offset blocks for steel post assemblies shall be made of synthetic materials in accordance with 2.1.2.

**2.4 Rails and Fittings for Beam Guardrail.**

**2.4.1** Rails and fittings shall be as shown in the current edition *A Guide to Standardized Highway Barrier Hardware, AASHTO – AGC- - ARTBA Joint Cooperative Committee*. Galvanized steel rail elements, terminal sections, bolts, nuts, and other fittings shall conform to AASHTO M 180 (except that paragraph 11, Marking, shall not apply), Type II, Class A. Galvanized steel rail elements and terminal sections shall be treated with a solution of sodium dichromate or other approved chemical solutions so as to prevent or reduce storage stain.

**2.4.1.1** Miscellaneous steel hardware not shown in *A Guide to Standardized Highway Barrier Hardware, AASHTO – AGC- - ARTBA Joint Cooperative Committee* designation shall conform to ASTM A 36 and A 500 as appropriate. Hardware shall be galvanized, after all fabrication, in accordance with AASHTO M 232.

**2.4.2** Steel rail elements shall be shop punched to allow for 6 ft. – 3" post spacing or as required. Where the rail is on a curve having a radius of 150 ft. or less, the rail shall be shop curved. The splice shall make contact throughout the area of the splice. Guardrail parts furnished under this specification shall be interchangeable with similar parts, regardless of the source of manufacture.

**2.4.3** The post bolt and connection shall withstand a 5,000 lbs. pull in either direction.

## SECTION 606

**2.5 Anchor blocks.** Anchor blocks shall be as shown on the plans.

### **2.6 Concrete Anchors and Barriers.**

**2.6.1** Concrete shall be Class AA conforming to [520.1.2](#). The cement shall be Type III Portland cement as specified in AASHTO M 85. Slump shall be closely controlled between 2 and 3". Concrete used in extrusion or slip form barrier shall be of such consistency that after extrusion, it shall maintain the shape of the barrier without support.

**2.6.1.1** Corrosion inhibitor admixture shall conform to AASHTO M 194 (ASTM C 494) Type C as included on the [Qualified Products List](#), Section 520.

**2.6.2** Reinforcing steel shall conform to [Section 544](#).

**2.6.3** Structural material including end connectors shall conform to the applicable portions of [Section 550](#).

**2.6.3.1** Galvanizing shall conform to AASHTO M 111.

**2.6.4** Mortar for patching, when permitted, shall be composed of the exact ingredients of the concrete with the coarse aggregate omitted.

**2.6.5** Preformed Expansion Joint Filler shall conform to AASHTO M 153, Type III or AASHTO M 213.

**2.6.6** Water repellent coating on concrete barrier, except portable concrete barrier for traffic control, shall be Silane/Siloxane conforming to [534.2.2](#).

**2.7 Delineators.** Delineators shall conform to [Section 621](#).

### **2.8 Handrail.**

**2.8.1** Steel Pipe for rails and posts shall conform to ASTM A 53, Schedule 40, Standard Weight of the diameter shown on the details. Pipe shall be galvanized after fabrication in accordance with the requirements of AASHTO M 111.

**2.8.2** Grout for anchoring the pipe posts shall be High Strength, Impact Resistant, Non-shrink Grout as included in Section 528 on the [Qualified Products List](#).

**2.9** Retroreflective sheeting shall conform to AASHTO M 268 (ASTM D 4956) minimum of Type IV sheeting.

### **2.10 Temporary Impact Attenuators.**

**2.10.1** Temporary impact attenuation devices for traffic control shall be designed to meet the requirements of the National Cooperative Highway Research Program (NCHRP) Report 350 at a minimum of Test Level 2 [43.5 mph] or Test Level 3 [62.1 mph] as specified in the item description.

**2.10.2** Temporary impact attenuation devices (redirective and Non-redirective) shall be products as included on the [Qualified Products List](#) unless allowed per 2.12.4 or specifically specified in the Contract.

**2.10.3** Temporary impact attenuation devices shall be redirective or non-redirective as specified in the item description. Redirective devices shall be capable of redirecting the impacting vehicle over the full length of the device.

**2.10.4** Sand barrels and water filled arrays will not be allowed for use November 1<sup>st</sup> to April 15<sup>th</sup> unless they are at least ten feet away from the travelway (measured to the face) or specifically approved in writing by the Engineer. If approved by the Engineer for winter use, the sand or water shall be treated to prevent freezing.

**2.10.4.1** The Contractor may elect to utilize either sand barrels or water filled attenuators for the non-redirective category between April 15<sup>th</sup> and November 1<sup>st</sup>. The Contractor shall provide certification that the unit complies with the NCHRP 350 test level specified.

**2.10.4.2** Sand Barrel arrays and water filled impact attenuators shall be made up of modules that are durable and weather proof with outer components formulated to resist deterioration from ultraviolet rays.

**2.10.4.3** When a project that is anticipated to be completed prior to November 1<sup>st</sup>, is delayed until the next season due to the Contractor's method of construction, it shall be the responsibility of the Contractor to replace sand barrel arrays with an impact attenuation device included on the [Qualified Products List](#), at no cost to the Department. When an extension of time is granted under [108.07](#) the additional cost for replacement will be paid in accordance with the provisions of [109.04](#).

**2.10.5** Used impact attenuators, beam guardrail, and terminal units for traffic control barrier, in good operating condition will be allowed with approval from the Engineer.

**2.10.6** Truck mounted attenuators (TMA) may be used temporary impact attenuators in accordance with 619 with approval by the Engineer. In no case shall a TMA be left in place during non-work hours, it shall be stored outside the clear zone.

**2.11 Temporary beam guardrail.**

- 2.11.1 Temporary beam guardrail shall meet the requirements of Item 606.120 (steel posts) or Item 606.140 (wood posts).
- 2.11.2 Used beam guardrail and terminal units in good operating condition, will be allowed with approval from the Engineer.

**2.12 Terminal Units.**

2.12.1 Terminal units shall be of the type specified in the Contract or as ordered by the Engineer. The same terminal unit model of each type specified shall be used throughout the project, with the exception of the temporary terminal units.

**2.13 Replacement Components.**

2.13.1 Steel beam for beam guardrail, including hardware shall consist of standard beam rail, bolts, nuts, washers and any other materials necessary to connect the rail to the offset blockouts.

2.13.2 Post Assemblies of the type specified for Beam Guardrail Posts shall consist of offset blocks, bolts, nuts, washers and any other materials necessary to connect the, rail, offset blocks and posts.

2.13.2.1 Offset blocks for steel post assemblies shall be made of synthetic materials conforming to 2.1.2.

**Construction Requirements****3.1 Posts.**

3.1.1 All posts shall be set plumb at the required spacing and locations by either auguring, excavating or driving. The face of the post nearest the road shall present a vertical line from the top to bottom.

3.1.2 The bottom of the augured or excavated holes shall be thoroughly tamped to grade.

3.1.3 Post and anchor holes shall be backfilled with acceptable material placed in layers and thoroughly compacted with a power tamper.

3.1.4 The wood offset blocks shall be “toe nailed” to the rectangular wood posts to prevent them from turning.

3.1.4.1 Breakaway wood posts A and B shall be set in augured, pre-driven or hand dug holes and backfilled in accordance with 3.1.3.

**3.2 Beam Rail.**

3.2.1 Beam guardrail shall be erected to provide a smooth continuous rail conforming to the line and grade of the highway. Corrugated rail elements shall be lapped so that the exposed end of each element is away from approaching traffic. Tube-type beam elements shall be bolted and joined as shown on the plans. Expansion joint bolts shall be tightened, but not to a degree which will prevent the rail elements from sliding past each other longitudinally. All other bolts shall be drawn tight.

3.2.2 All metal work shall be fabricated in the shop. No punching, cutting, or welding shall be done in the field. Holes may be drilled or cutting done for special details only.

3.2.3 Galvanized beam rail shall be stored to prevent wet storage stain. Storage shall be off the ground and individual rail elements shall be separated with spacers to provide free access of air. The beam rail shall be inclined in a manner which will provide continuous drainage.

3.2.4 All damage to galvanized surfaces, threaded portions of all fittings and fasteners, and cut ends of bolts after assembly, shall be repaired by thoroughly wire brushing the damaged area and painting it with 2 coats of approved zinc-rich primer.

3.2.5 At each location where an electric transmission, distribution, or secondary line crosses any of the types of metal guardrail covered by these specifications, the guardrail shall be grounded as required by the electric utility company.

3.2.5.1 At locations where electric lines run parallel and in close proximity to metal guardrail, grounding systems may be required by the electric utility company.

3.2.6 All beam rail shall include retroreflectorized delineators, white or yellow, placed in accordance with the [NHDOT Standard Plans](#).

3.2.7 Double nested guardrail shall be as detailed on the plans or as ordered.

**3.3 Terminal Units.**

Terminal sections shall be installed at each end of every installation of beam guardrail unless otherwise specified. Before installation, the Contractor shall provide the Engineer with copies of the manufacturer’s documents indicating satisfactory testing in accordance with NCHRP 350 and/or its subsequent revisions and of the approval by the FHWA for use of the terminal unit as intended. The Contractor shall also provide the Engineer with copies of the manufacturer’s detail sheets and installation guide

## SECTION 606

detailing all requirements and system dimensions prior to installation. The Contractor shall provide a list of component parts to the Engineer to be forwarded to the appropriate maintenance office.

**3.3.1** Terminal units or sections shall be installed as shown on the plans, specified by the manufacturer or ordered.

**3.3.2** Type IV retroreflective sheeting shall be applied to the approach nose after fabrication and assembly but prior to the installation of bolts, if terminal units are installed less than 6 ft. from the edge of pavement as follows:

One-Way Roadways: Retroreflective yellow with black stripes sloping downward at an angle of 45 degrees toward the roadway on both sides of the roadway. The width of the stripes shall be 3".

Two-Way Roadways: Same as One-Way Roadway except the reflective sheeting is to only be placed on the right side of the roadway with no sheeting on the left side of roadway.

**3.3.2.1** Retroreflective sheeting on ELT terminal units shall be 12" high x 24" wide and shall be attached to the 24" corrugated steel pipe 4" down from the top by applying the retroreflective sheeting to 0.080" thick, 12 in x 24" aluminum sheet which shall be attached with six M6 – 1/4" – 20 x 1" bolts with, lock washers and nuts fastened on the top, middle and bottom edges.

**3.3.2.2** Retroreflective sheeting on flat-ended terminal units shall be a minimum of 12" wide and 24" high unless the dimensions of the flat end surface of the terminal unit are less. In the case of the width being less than 12" it shall cover the entire width of the flat surface. In the case of the height being less than 24" it shall cover the entire height of the flat surface. If the 12" wide sheeting does not cover the full width of the flat surface, the sheeting shall be placed on the roadway edge of the terminal unit. If the 24" high sheeting does not cover the full height of the flat surface, the sheeting shall be placed from the top down.

**3.4 Wood rail.** Wood rail shall be constructed as shown on the plans. Wood surfaces cut or damaged shall be brush treated with 2 applications using material of the same specification as that used in the preservative treatment.

**3.5 Resetting.** The existing guardrail and/or terminal units including anchorages shall be dismantled in a careful manner that eliminates damage, suitably stored, and reinstalled. Unless otherwise ordered, hardware and fittings shall be packed in substantial containers. Replace posts and hardware that the Engineer deems unsuitable for reuse with new, paid for under appropriate Contract items or as provided for in [109.04](#).

**3.5.1** The Contractor, together with the Engineer, shall inspect the guardrail and terminal unit before dismantling and note any damaged or missing parts. Damaged or missing parts shall be repaired / replaced as directed by the Engineer. Material damaged due to the Contractor's negligence shall be replaced with new materials at the Contractor's expense.

### **3.6 Temporary Impact Attenuators and Temporary Beam Guardrail.**

#### **3.6.1 Temporary Impact Attenuators for Traffic Control.**

**3.6.1.1** Submit technical data to the Engineer for approval prior to installing the attenuator. This data shall include the overall length, width, the number of bays or modules, connection details, the point at which redirection is provided (where length of need is established on the device), the performance category (redirective or non-redirective), maximum design speed and the NCHRP test level the attenuator was tested to.

**3.6.1.2** All work relating to the placement of the components of the impact attenuation device including transition sections shall be as shown on the manufacturer's details and shall be approved by the Engineer. Installation shall be in accordance with the manufacturer's recommendations.

**3.6.1.3** The impact attenuation device shall be located on a concrete pad or prepared base as recommended by the manufacturer.

**3.6.1.4** Provide a positive connection between the end of concrete barrier or guardrail and the impact attenuation device as recommended by the manufacturer.

**3.6.1.5** Any device or device components damaged during installation shall be replaced with new parts from the manufacturer at the Contractor's expense.

**3.6.1.6** The Contractor shall have on hand one replacement parts kit as recommended by the manufacturer per project for each model type used prior to being installed.

**3.6.1.7** Temporary impact attenuators for traffic control shall remain the property of the Contractor and they shall be removed when the project is complete or they are no longer needed.

**3.6.2** Damaged temporary beam guardrail or temporary impact attenuators shall be repaired within 24 hours after notification by the Engineer.



**3.6.3** Temporary beam guardrail shall be installed meeting the requirements of Item 606.120 (steel posts) or Item 606.140 (wood posts) except that approved used material may be installed.

### **3.7 Concrete Barriers.**

#### **3.7.1 General.**

**3.7.1.1** Concrete barriers shall be supplied as precast units or constructed cast-in-place as specified to the configuration and details shown on the plans. Portable concrete barrier for traffic control shall be precast units. Minor deviations in the shape shall be submitted to the Engineer for approval.

**3.7.1.1.1** Concrete barrier shall conform to the following tolerances:

- A. Cross-sectional dimensions shall not vary from the dimensions specified by more than 1/4" and shall not be out of plumb by more than 1/4", except the base which shall not vary by more than 1/2"
- B. Longitudinal dimensions shall not vary from the dimensions specified by more than 1/4" per 10 ft.
- C. Surface straightness irregularities when checked with a 10 ft. straight edge shall not exceed 1/4"
- D. Bar Reinforcement cover shall not vary from the dimensions specified by more than 1/2"

**3.7.1.2** Sections of barrier shall be uniform in color and in good condition, free from cracked or spalled surfaces.

**3.7.1.3** The layout and placement of the concrete barriers shall be to the alignment and elevations shown on the plans or as directed. Before any concrete or precast barrier may be placed, the subbase shall be compacted to 95% density in accordance with the applicable tests as specified in [304.3](#) and fine graded to a tolerance of  $\pm 1/2$ " of the true grade at any location under the barrier. Whenever possible, as determined by the Engineer, concrete placing operations shall not begin until the subbase has been fine graded ahead at least 1,000 ft.

**3.7.1.4** All concrete barriers shall include retroreflectorized delineators, white or yellow, placed in accordance with the [NHDOT Standard Plans](#).

**3.7.1.5** Concrete shall contain corrosion inhibitor (calcium nitrate) admixture added at the rate of 4 gallons per cubic yard.

**3.7.1.6** Form work shall be in accordance with [520.3.2](#), externally braced in like new condition without any projections or depressions which would detract from the required finish. Proper care and precautions shall be exercised in removing forms to ensure no damage results to the finished surface of the barrier.

**3.7.1.7** Reinforcing steel shall be placed in accordance with [Section 544](#).

**3.7.1.8** Concrete Class F in accordance with [Section 520](#) may be substituted for aggregate base course and hot bituminous pavement in the patching on the roadway side of concrete barrier. Concrete thickness shall be not less than that of the adjacent pavement.

**3.7.1.9** Concrete barrier, except portable concrete barrier for traffic control, shall receive a Class 1, Ordinary Finish in accordance with [520.3.12](#).

**3.7.1.10** Water repellent (Silane/Siloxane) shall be applied to concrete barrier, except portable concrete barrier for traffic control, in accordance with [534.3](#).

**3.7.1.11** Defects are divided into two categories, minor defects and major defects. Minor defects in the barrier may be repaired in the field. Major defects shall be cause for rejection of the section, or the section shall be repaired in the manner directed by the Engineer.

**3.7.1.11.1** Minor defects are defined as holes, honeycombing or spalls which are 6" or less, in diameter, and which do not expose the outermost surface of the steel reinforcement. Surface voids 3/8", or less, in diameter and 3/8", or less, in depth are not considered defects and they do not require repair.

**3.7.1.11.2** Major defects are defined as, any defect which does not meet the definition of a minor defect or minor defects which, in aggregate, comprise more than 2% of the surface area of the barrier section.

**3.7.1.12** Repair of hardened concrete shall be as follows:

- A. Minor Defect Repair. Repair shall be made with a Fast Set Non-shrink Patching Mortar appearing on the [Qualified Products List](#), Section 520. Methods of repair shall be acceptable to the Engineer. The color of the repaired portion shall match as nearly as practicable, the color of the surrounding concrete. Repaired portions shall exactly match shape requirements.
- B. Major Defect Repair. Major defect repair methods shall be pre-approved by the Engineer.

## SECTION 606

### 3.7.2 Cast-in-Place Barriers.

Cast-in-place barriers shall be constructed by either the “fixed forms” or “extrusion or slip form” method or a combination, at the Contractor’s option.

#### 3.7.2.1 General.

**3.7.2.1.1** Contraction joints shall be formed or saw cut normal to the pavement. The spacing shall be every 20 ft., as shown on the plans or as ordered by the Engineer. The joints shall conform to the dimensions as shown on the plans or standard sheets. If the joints are saw cut, they shall be saw cut so no damage to the concrete will result, within a maximum time of 8 hours. If sawing or forming joints is performed before the concrete has hardened, the adjacent portions of the barrier shall be supported firmly with close fitting shields. The liquid curing compound, if used, shall be reapplied at the saw cut.

**3.7.2.1.2** Expansion joints shall be formed normal to the pavement with Preformed Expansion Joint Filler and shall provide for expansion of ½”. The filler material shall be cut to conform to the cross section of the barrier.

**3.7.2.1.2.1** The expansion joints shall be located at all immovable objects (bridge substructures, etc.), where shown on the plans, and/or as directed by the Engineer. Expansion joints shall not be required at regular intervals unless shown on the plans.

#### 3.7.2.2 Fixed Forms Barrier.

**3.7.2.2.1** Forms and subbase shall be thoroughly moistened in conformance to 520.3. Care shall be taken that form construction has been completed, embedment of required materials placed and removal of all foreign materials completed before the concrete is placed.

**3.7.2.2.2** Concrete shall be placed in its final position. Excessive movement of concrete by use of vibrators will not be permitted.

**3.7.2.2.3** Concrete shall not be dropped a distance of more than 5 ft. unless contained within a tremie, elephant trunk or other approved system.

**3.7.2.2.4** Concrete shall be consolidated as provided in 520.3.5.4 by means of high frequency internal vibrators within 15 minutes after it is deposited in the forms. Vibrators shall not be attached to, or held against the forms or the reinforcing steel. Care shall be taken to avoid the displacement of reinforcement.

**3.7.2.2.5** In the event of an emergency where placement continuity is affected, the Engineer will decide if a construction joint will be allowed and will direct the Contractor as to the location and manner in which the joint is to be constructed.

**3.7.2.2.6** Concrete shall be cured in compliance with 520.3.10.1. Forms shall not be removed for a period of 3 days or as directed.

### 3.7.3 Precast Barriers.

**3.7.3.1** Fabrication of precast units shall be performed by an approved commercial precasting plant. The provisions of 105.10 and 106.05 shall apply.

**3.7.3.2** Fabrication inspection of the precast barrier will be performed by the Department. A concrete mix design shall be prepared by the manufacturer and approved by the Bureau of Materials and Research prior to fabrication. The Contractor shall notify the Engineer at least 72 hours before casting barriers so that the necessary arrangements may be made for the Engineer to be present for inspection of the casting. The casting date shall be shown on the bottom of each section.

**3.7.3.3** The length of individual precast sections shall not exceed 20 ft. unless otherwise permitted. The length of individual sections of any one run shall be approximately the same. Precasting tolerance will allow no variations of more than 1/4” in any plan dimension.

**3.7.3.4** Unless shown on the plans, the Contractor's proposed method for joining and anchoring the sections shall be submitted for approval. Steel shapes exposed to weathering shall be galvanized.

**3.7.3.5** Compaction of the concrete into a dense uniform mass shall be accomplished by internal vibration to provide a smooth surface relatively free of voids. External vibration may be used when permitted.

**3.7.3.6** Care shall be taken to ensure that inserts including reinforcing steel remain in their proper locations. Ends of the individual sections shall be smooth and perpendicular to the top surfaces.

**3.7.3.7 Curing.** Concrete shall be water cured in compliance with Section 520. Water cured barrier shall not be shipped until the barrier has cured a minimum of 7 days. Steam curing of barriers shall be as follows:

**3.7.3.7.1** Furnish sufficient canvas and framework or other type of housing to completely enclose the concrete barrier sections so that the curing temperatures can be controlled.

**3.7.3.7.2** Live steam shall be introduced into the enclosure through a series of steam jets which shall be evenly spaced within the enclosure. In no case shall the steam jet impinge directly on the concrete formwork.

**3.7.3.7.3** The initial set of the concrete shall take place before steam is applied.

**3.7.3.7.4** The steam shall be maintained at 100 percent relative humidity to prevent loss of moisture and to provide excess moisture for proper hydration of the cement.

**3.7.3.7.5** During the application of the steam, the ambient air temperature shall increase at a rate not to exceed 40 °F per hour until a temperature of 160 °F is reached. Curing at 160 °F shall continue until concrete test cylinders, prepared at the time of placing, and cured under the same temperature and moisture conditions have attained 80 percent of the expected compressive strength.

**3.7.3.7.6** Necessary equipment for testing the cylinders shall be available at the fabricator's plant unless otherwise permitted.

**3.7.3.7.7** When discontinuing steam, the ambient air temperature shall not decrease at a rate exceeding 40 °F per hour until the temperature has reached 20 °F above the temperature of the air to which the concrete will be exposed.

**3.7.3.7.8** The concrete shall not be exposed to temperatures below freezing for 6 days after casting.

**3.7.3.7.9** The precast barrier shall not be moved until 24 hours after casting. The precast sections must be in the position and location for curing prior to removing forms. The lifting hooks shall not be used to move the barrier until curing is complete. Handling shall at all times be performed in a manner to prevent damage to the concrete.

**3.7.4 Portable concrete barrier for traffic control.** Portable concrete barrier for traffic control may be approved used barrier. Portable concrete barrier for traffic control shall include relocating the barriers on the project as well as transporting the barriers to and from the project.

### **3.8 Handrail.**

**3.8.1** Fabricate handrails to the dimensions and details shown on the plans.

**3.8.1.1** Top railing shall be continuous throughout entire length of railing, except as noted in 3.8.4.

**3.8.1.2** Interconnect handrail members by butt-welding or welding with internal fittings. Welding shall conform to ANSI/AWS D1.1 Chapter 10, Tubular Structures. At tee and cross connections notch ends of intersecting members to fit contour of pipe to which end is joined and weld all around.

**3.8.1.3** Form simple and compound curves by bending pipe in jigs to produce uniform curvature. Maintain cylindrical cross-section of pipe throughout entire bend without buckling, twisting, cracking or otherwise deforming exposed surfaces of pipe.

**3.8.2** The Contractor shall Install the pipe and hardware for handrail as shown or ordered.

**3.8.2.1** Anchor posts in preset sleeves or drilled holes. Sleeves or holes shall be not less than 12" deep with an inside diameter not less than 1/2" greater than the outside diameter of the post. Sleeves shall have a steel plate closure welded to the bottom and a friction fit, removable cover designed to keep the sleeve clean and hold the 1/2" below the finished surface of concrete or mortar rubble masonry.

**3.8.2.2** Set handrail accurately in location, alignment and elevation with edges and surfaces level, plumb and true. Fill annular space between posts and sleeve or holes with grout.

**3.8.3** Damage to galvanized surfaces during erection shall be repaired by cleaning the damaged area as specified in 550.3.17.2, pretreating as specified in 550.3.17.7 and painting with 2 coats of approved zinc-rich primer. The second coat shall not be applied until the first coat has been approved.

**3.8.4** Provide slip joint expansion joints, at intervals not to exceed 40 ft., located within 6" of posts. Slip joint shall be formed with an internal sleeve extending 2" beyond the joint on either side with the sleeve securely fastened to one side.

**3.8.5** Handrail shall be installed in a timely manner to ensure pedestrian safety.

#### **Method of Measurement**

**4.1** The accepted quantities of guardrail, new, temporary or reset, will be measured either by the unit or by the linear foot to the nearest 0.1 of a foot, as follows:

**4.1.1** Corrugated beam guardrail indicated as "standard section" and Terminal Section Type E-2 will be measured by the linear foot as shown on the plans.

**4.1.1.1** Terminal units will each be measured by the unit, except E-2 as noted above.

## SECTION 606

- 4.1.2 Wood guardrail, pipe guardrail and double faced beam guardrail will be measured from end to end of rail by the linear foot, unless otherwise shown on the plans.
- 4.1.3 Handrail will be measured from end to end of rail by the linear foot, to the nearest 0.1 of a foot.
- 4.1.4 Steel beam for beam guardrail, including hardware will be measured by the linear foot.
- 4.1.5 Post replacements and assemblies for beam guardrail posts will be measured by the each.
- 4.1.6 Removal and disposal of materials being replaced shall be subsidiary to the replacement items.
- 4.2 Anchorages shown on the plans as integral parts of terminal units or sections paid for by the unit will not be measured separately; other anchorages as specified, both new and reset, will be measured by the number of units installed.
- 4.3 Measurement of the temporary beam guardrail and temporary terminal units of the type specified will be in accordance with 4.1.
- 4.4 The accepted quantities of concrete barrier, permanent or portable for traffic control, will be measured by the linear foot as follows:
- 4.4.1 Permanent concrete barrier will be measured by the foot to the nearest 0.1 of a foot from end to end along the top of the barrier section.
- 4.4.2 Portable concrete barrier for traffic control will be measured by the linear foot for barrier delivered and installed for use on the project. Relocating portable concrete barriers on the project will not be measured for payment.
- 4.5 Delineators will be measured in accordance with 621. Delineators required for temporary guardrail and portable concrete barrier for traffic control will not be measured.
- 4.6 Temporary Impact Attenuation devices for traffic control will be measured by the unit. No separate measurement will be made for any materials necessary to connect the impact attenuation device to the concrete barrier or guardrail. No measurement will be made for the initial concrete pad or base materials required for proper installation. Relocating impact attenuation devices for traffic control on the project will not be measured.

### Basis of Payment

- 5.1 The accepted quantities per linear foot for guardrail, concrete barrier, and E-2 terminal units will be paid for at the Contract unit price per linear foot for guardrail complete and in place.
- 5.1.1 The accepted quantities for terminal units, bridge approach units, anchorages other than anchorages included with terminal units, for all types specified, will be paid for at the Contract unit price for units complete and in place.
- 5.2 New material required for resetting guardrail, other than that damaged due to the Contractor's negligence, will be paid for as provided in 109.04.
- 5.3 The accepted quantity of permanent concrete barrier of the type specified and portable concrete barrier for traffic control will be paid for at the Contract unit price per linear foot.
- 5.3.1 Relocating the barriers on the project and transporting the barriers to and from the project will be subsidiary.
- 5.3.2 Mortar for patching joints between units on permanent concrete barriers when required will be subsidiary.
- 5.3.3 Miscellaneous steel for connecting individual units or end units will be subsidiary.
- 5.3.4 Hot bituminous pavement placed adjacent to the concrete barrier for a maximum width of 1 ft. will be paid for as Item 403.12. Concrete Class A substituted for aggregate base course and hot bituminous pavement will be paid for as Item 403.12 at 2.0 tons per cubic yard.
- 5.3.5 Water repellent required on concrete barrier will be subsidiary.
- 5.4 The accepted quantity of handrail will be paid for at the Contract unit price per linear foot complete in place.
- 5.4.1 Grout will be subsidiary to handrail.
- 5.5 Delineators will be paid for in accordance with Section 621, except delineators required for temporary guardrail and portable concrete barrier for traffic control will be subsidiary.
- 5.6 Impact attenuation devices (redirective or non-redirective), test level 2 or 3 as required will be paid for at the Contract unit price per unit complete in place.
- 5.6.1 All excavation and materials necessary to install and connect the temporary impact attenuation device to traffic control barrier will be subsidiary.

**5.6.2** The initial concrete pad for the temporary impact attenuation device shall be subsidiary. The concrete pad for subsequent locations shall be paid as provided for in 109.04. Removal of concrete pads; relocating the temporary impact attenuators on the project; and transporting to and from the project shall be subsidiary.

**5.6.3** Any device or device components damaged by the Contractor's negligence shall be replaced at the Contractor's expense.

**5.7** No separate payment will be made for any excavation required except for material classified as rock structure excavation and will be paid as provided for in Section 206.

#### KEY TO ITEM NUMBERS FOR GUARDRAIL ITEMS

Item Number	Description	Unit
606.00C	Beams for Guardrail	Linear Foot
606.0001	Steel Beam for Beam Guardrail, Including Hardware	Each
606.01A	Posts for Guardrail	Each
606.012	W6x9 Steel Post Replacement for Beam Guardrail	Each
606.0122	Steel Post Assemblies for Beam Guardrail Posts	Each
606.014	6" x 8" Wood Post Replacement for Beam Guardrail	Each
606.0142	6" x 8" Wood Post Assemblies for Beam Guardrail Posts	Each
606.1A51	Beam Guardrail (Terminal Unit Type MELT)	Unit
606.1A52	Beam Guardrail (Terminal Unit Type ELT)	Unit
606.1A7	Beam Guardrail (Terminal Unit Type G-2)	Unit
606.1A96	Beam Guardrail (Terminal Section Type E-2)	Linear Foot
606.21A,B,C	Double-Faced Steel Beam Guardrail (Galvanized)	Linear Foot
606.402	Concrete Barrier, Double-Faced	Linear Foot
606.4029	Modified Concrete Median Barrier	Linear Foot
606.411	Concrete Barrier, Single-Faced, Precast	Linear Foot
606.412	Concrete Median Barrier, Double-Faced, Precast	Linear Foot
606.4129	Modified Concrete Median Barrier, Precast	Linear Foot
606.417	Portable Concrete Barrier (For Traffic Control)	Linear Foot
606.421	Concrete Barrier, Single-Faced, Cast-in-Place	Linear Foot
606.422	Concrete Barrier, Double-Faced, Cast-in-Place	Linear Foot
606.4229	Modified Concrete Median Barrier, Cast-in-Place	Linear Foot

\*Linear foot except that terminal units are by the unit.

#### A Type of Post

- 0 Open
- 1 Light weight steel (S3x5.7)
- 2 Medium weight steel (W6x8.5)
- 3 Open
- 4 6" x 8" wood
- 5 Open
- 6 Aluminum, size per plans
- 7 Heavy weight steel (W6x15.5)
- 8 Open
- 9 Aluminum or steel -- Contractor's option, size per plans

#### B Post Spacing or Type of Unit (Spacing of terminal units is standardized on the plans)

- 0 "Standard Section" with 6 foot – 3" spacing
- 1 Open
- 2 Open
- 3 Open
- 4 Variable: 25 ft. to 6 ft. – 3" or 3-1/2 ft. to 1-1/2"
- 5 Open
- 6 Open

**SECTION 606**

7	Terminal Unit G-2	Unit
8	Bridge Approach Unit	Unit
C Rail Material		
0	Steel (galvanized)	
1	Open	
2	Double nested	
3	Thrie Beam	
4	Open	
5	Steel Rubbing Rail (galvanized)	
6	Steel Top Hand Rail (galvanized)	
7	Steel Top Pipe Rail (galvanized)	
8	Open	

606.5A, B, C      Wood Guardrail      Linear Foot

A Type of Wood Rail

- 1 Single 6" x 8"
- 2 Double 6" x 8"
- 5 Double 4" x 6"

B Type of Posts

- 0 5 ft.-8" x 8" wood
- 1 6 ft.-6" x 8" wood
- 2 5 ft.-9" by W6x8.5 steel
- 3 5 ft.-9" by W6x15.5 steel
- 4 1 foot -5" by W6x15.5 steel
- 5 2 ft.-5-1/4" by W6x15.5 steel

C Post Spacing

- 7 7 ft.-6"
- 8 8 ft.-0"

606.6A, B, C      Handrail      Linear Foot

A Type

- 1 Step
- 2 Ramp
- 3 Safety Rail

B Guard Required

- 0 No Guard
- 1 With Guard

C Material

- 1 Steel

606.82	Anchorage for Beam Guardrail	Each
606.83	Anchorage for Strong Beam Guardrail	Each
606.91	Resetting or Setting Guardrail	Linear Foot
606.92	Resetting Anchorages	Each
606.93	Temporary Beam Guardrail	Linear Foot

606.9512	Temporary Impact Attenuation Device (redirective), Test Level 2	Unit
606.9513	Temporary Impact Attenuation Device (redirective), Test Level 3	Unit
606.9522	Temporary Impact Attenuation Device (non- redirective), Test Level 2	Unit
606.9523	Temporary Impact Attenuation Device (non-redirective), Test Level 3	Unit

## SECTION 607

### SECTION 607 – FENCES

#### Description

**1.1** This work shall consist of the constructing, removing and resetting railings, fences, and gates as shown on the plans or as ordered. This work shall include furnishing and installing the required electrical grounds.

**1.2** This work shall consist of constructing, maintaining relocating, and removal of a temporary chain link fence, including necessary self-supporting post assembled and gates, and locking devices and keys for the purpose of protecting active construction as noted in the Contract or as ordered.

#### Materials

##### 2.1 Woven Wire Fence.

**2.1.1** Wire shall conform to ASTM A 116, Design No. 1047-12-11. Minimum coating shall meet Class 1.

**2.1.2** Steel posts and angle braces shall conform to ASTM A 499 and A 702. Posts shall be galvanized in accordance with AASHTO M 111. Fittings, hardware and other appurtenances not specifically covered by the plans and specifications shall be standard commercial grade, manufactured in accordance with current standard practice.

**2.1.3** Tie wires and wire clips shall be of equivalent size and coating as specified in 2.1.1.

**2.1.4 Gates.** Gate posts shall conform to 2.1.2. Wire shall conform to 2.1.1. The frame, center brace, diagonal tension rod, and hardware shall conform to the standards shown on the plans.

##### 2.2 Chain Link Fence.

**2.2.1** Chain link fence shall conform to AASHTO M 181.

**2.2.2** Unless otherwise stipulated, fencing material shall be 9 gauge, 2" mesh, Type II or Type IV fabric. The specific diameter for Type IV fabric is the metallic coated diameter and the PVC coating shall not be used when determining wire size. All vinyl-coated fabric used on the project shall be the same shade of color called for in the plans.

**2.2.2.1** Fabric up to and including 60" high shall be knuckled at the top and bottom selvages. Fabric over 60" high shall be twisted and barbed on the bottom selvage and knuckled on the top selvage.

**2.2.3** Metallic coated steel posts, rails, or gate frames shall conform to AASHTO M 181 Grade 1 or Grade 2. Miscellaneous fittings and hardware shall conform to AASHTO M 181 Section 29.

**2.2.4** Tension bars shall not be less than 0.25 by 0.75".

**2.2.5** Wire ties and clips for fastening fabric to posts and top rail shall be of the same material and the same or larger gauge as the fabric.

##### 2.2.6 Temporary Chain link Fence.

**2.2.6.1** Fabric shall conform to AASHTO M 181, Type II. Used Fabric may be used with approval of the Engineer.

**2.2.6.2** Line post, end posts, post assemblies and hardware shall be steel and conform to the applicable provisions of AASHTO M 181. Used posts, assemblies and hardware may be used with the approval of the Engineer.

**2.2.6.3** If top rails are not installed on chain link fence a tension wire shall be used and shall be steel coil spring wire, 7 gauge or larger in diameter in accordance with the applicable provisions of AASHTO M 181.

**2.3 Barbed wire.** Barbed wire, unless otherwise specified, shall be fabricated from 2 ply 12-1/2 gauge Class 3 zinc-coated steel wire, with 14 gauge 4-point barbs spaced not more than 5" apart, and shall meet the requirements of ASTM A 121.

**2.4** Additional materials required for resetting railings or fencing or both shall conform in quality and type to the materials in the existing fence.

**2.5** Concrete shall conform to [Section 520](#).

**2.6** Protective coating for contact surfaces of aluminum and concrete shall be either an approved zinc-rich primer, or an approved bituminous paint meeting FSS TT-C-494.

#### Construction Requirements

##### 3.1 General.

**3.1.1** The Contractor shall perform such clearing and grubbing as may be necessary to construct the fence to the required grade and alignment.



**3.1.2** At locations where breaks in a run of fencing are required, or at intersections with existing fences, appropriate adjustment in post spacing shall be made.

**3.1.3** The fence shall be permanently connected to the existing fence as shown in the plans or as approved by the Engineer.

**3.1.4** Posts, braces, or anchors shall be embedded in concrete and temporary guys or braces may be required to hold the posts in proper position until such time as the concrete has set sufficiently to hold the posts. Unless otherwise permitted, no materials shall be installed on posts or strain placed on guys and bracing set in concrete until 3 days have elapsed from the time of placing of the concrete.

**3.1.4.1** The portions of aluminum posts which will be in contact with concrete shall be coated both inside and outside with protective coating to 1" above the top of the concrete. The coating shall be allowed to dry for at least 24 hours before the concrete is placed.

**3.1.4.2** In wet areas, when it is impractical to place concrete, steel drive anchor assemblies may be required.

**3.1.5** All posts shall be set plumb and firm and to the required grade, spacing, and alignment. Cutting of the posts will be allowed only with the approval of the Engineer.

**3.1.6** When it is necessary to drill into rock to set a steel post, the post may be shortened, provided a minimum length of 12" of post is grouted in the rock.

**3.1.7** At each location where an electric transmission, distribution, or secondary line crosses any of the types of metal fences covered by these specifications, the fence shall be grounded as required by the electric utility company.

**3.1.7.1** At locations where electric lines run parallel and in close proximity to metal fences, grounding systems may be required by the electric utility company.

**3.1.8** Where it is impractical to conform the fence to the general contour of the ground, as at ditches, the opening beneath the fence shall be closed as ordered.

**3.1.9** All surplus material and other debris shall be removed.

## **3.2 Woven Wire Fence.**

**3.2.1** The wire shall be stretched so that not more than 1/2 of the hump is removed from the horizontal wire. The top and bottom wire and alternate parallel interior wires shall be fastened at every post in such a manner that each interior wire shall have a fastening at every other post.

**3.2.1.1** Runs of woven wire fence 600 ft. or less in length shall be erected with not more than one splice between post assemblies. Splicing the wire will be permitted at posts only, except as otherwise provided. Each horizontal strand of wire shall be wrapped completely around posts at post assemblies and shall be securely fastened by winding the end of the wire about the same strand where it leads up to the post. Other devices designed specifically to splice fencing wire may be used when approved. Post assemblies shall be constructed at all corners, ends, gates, at extreme sags or humps in grade, and at ends of 600 ft. lengths of fencing.

## **3.3 Chain Link Fence.**

**3.3.1** The fence shall be erected so that the bottom is between 1 and 2" above the ground.

**3.3.1.1** The top rail shall pass through the post tops to form a continuous brace from end to end of each section of fence, and shall be securely fastened to the posts at post assemblies by suitable clamps.

**3.3.1.2** Post assemblies as shown on the plans shall be installed at ends, at corners or changes in line where the angle of deflection is 30 degrees or more, at abrupt changes in vertical grades where pull posts are required, and at gates. Moreover, at least one post assembly shall be installed for every 500 ft. of run.

**3.3.1.3** Braces shall be spaced approximately midway between the top and the ground, and extend to the first line post. Braces shall be securely fastened to posts by suitable clamps.

**3.3.1.4** Truss rods shall be installed as shown on the plans.

**3.3.2** Unless otherwise shown on the plans, when barbed wire is required, arms shall be installed outward.

**3.3.3** Fabric shall be fastened to the post with suitable fabric bands, stretcher bar bands, and hook bolts and to the top rail with tie wires as shown on the plans. The fabric shall be free from sags and bends.

**3.3.4** All holes within 2 ft. of the fence shall be filled with suitable approved material and compacted properly.

## SECTION 607

### 3.3.5 Temporary Chain Link Fence.

**3.3.5.1** The temporary chain link fence shall be installed in accordance with the applicable provisions of this section as shown on the plans or ordered.

**3.3.5.2** Tension wire, if installed, shall be installed at the top of the fence and tie spacing shall be 12" center to center.

**3.4** Fences holding livestock shall be promptly replaced by temporary fencing, with no extra compensation, during the time between the removal of the old fence and the erection of the new fence. Fencing meeting the specifications for the project may be used in its permanent location after having been used as temporary fence provided the fencing has not been damaged.

**3.5 Gates.** Gates shall be firmly and securely erected in accordance with the recommendations of the manufacturer and as directed.

**3.6 Resetting.** The existing railing or fencing shall be carefully removed, transported and reset at the required location. The reset railing or fencing shall be at least equivalent in strength and appearance to the original railing or fencing. Additional materials such as fittings or hardware shall be furnished and installed as necessary.

**3.7 Barbed wire.** The installation of barbed wire along the right-of-way is not allowed (see RSA 236:15).

#### Method of Measurement

**4.1** All fence, new or reset, will be measured by the linear foot, to the nearest 0.1 of a foot. Measurement will be along the top of the fence for each continuous run.

**4.1.1** Woven wire fence and chain link fence will be measured from center to center of end posts or gate posts as the case may be.

**4.1.2** Railing reset will be measured from end to end of rail.

**4.2** Post assemblies of the kind specified will be measured by the number of units. A unit shall consist of the post and all its required hardware and anchorages.

**4.3** Gates will be measured as complete units of the size and type specified.

**4.4** Temporary fence, including gates, locking devices (if necessary), and keys (if necessary), will be measured by the linear foot in accordance with 4.1.

#### Basis of Payment

**5.1** The accepted quantities of fencing of the type specified and of the height required will be paid for at the Contract unit price per linear foot, complete in place. This unit price shall include the cost of furnishing all labor, tools and equipment to satisfactorily complete the work and shall include excavation, concrete or steel drive anchor assemblies, posts, hardware, fencing and any repair of material damaged by the Contractor's operation. Gates and post assemblies, complete in place, shall be paid for as units. Clearing necessary to provide space for erecting the fencing will be paid for as provided under Item 201.6.

**5.1.1** Removing existing fence lines within 1 1/2 feet of the centerline of the new fence shall be subsidiary to the fence item.

**5.2** The accepted quantity of railing or fencing reset will be paid for at the Contract unit price per linear foot complete in place, except that the cost of furnishing additional materials, including new post concrete embedment, required through no fault of the Contractor will be paid as provided for in 109.04. Removing old concrete embedment from the posts will be subsidiary to the resetting item.

**5.3** The accepted quantities of temporary fence, including gates, locking devices (if necessary), and keys (if necessary), will be paid for by the linear foot, complete in place.

**5.3.1** Removal of temporary fencing, when ordered by the Engineer, shall be subsidiary.

**Pay items and units :**

607	Item Number		
	.A		
	Type of Fence		Linear Foot
	1 = Woven Wire Fence		
	2 = Chain Link Fence with Aluminum Coated Steel Fabric		
	3 = Chain Link Fence with Vinyl Coated Steel Fabric		
	8 = Miscellaneous Fence Types (Iron, Barbed Wire, etc.)		
	BC	Height of Fence (Feet & Inches, 10'+ use 1)	
	.4 = Post Assemblies		Each
	B		
	Type of Fence		
	1 = Woven Wire Fence		
	2 = Chain Link Fence with Aluminum Coated Steel Fabric		
	3 = Chain Link Fence with Vinyl Coated Steel Fabric		
	8 = Miscellaneous Fence Types (Iron, Barbed Wire, etc.)		
	CD	Height of Fence (Feet & Inches, 10'+ use 1)	
	.6 = Single Gate		Unit
	.7 = Double Gate		Unit
	B		
	Type of Fence		
	1 = Woven Wire Fence		
	2 = Chain Link Fence with Aluminum Coated Steel Fabric		
	3 = Chain Link Fence with Vinyl Coated Steel Fabric		
	8 = Miscellaneous Fence Types (Iron, Barbed Wire, etc.)		
	C	Height of Fence (Feet & Inches 10'+ use 1)	
	DE	Width of Gate	
	.9 = Resetting (includes gate)		Linear Foot
	B		
	Type of Fence		
	1 = Woven Wire Fence		
	2 = Chain Link Fence with Aluminum Coated Steel Fabric		
	3 = Chain Link Fence with Vinyl Coated Steel Fabric		
	7 = Wood Fence		
	8 = Miscellaneous Fence Types (Iron, Barbed Wire, etc.)		
	CD	Height of Fence	
607.99X	Temporary Chain Link Fence, X Feet High		Linear Foot
<b>Examples:</b>			
607.4308	Post Assemblies for Chain Link Fence with Vinyl Coated Steel Fabric, 8' High		Each
607.72824	Double Gate Chain Link Fence with Aluminum Coated Steel Fabric, 24' Wide X 8' High		Unit
607.9304	Resetting Chain Link Fence with Vinyl Coated Steel Fabric, 4' High		Linear Foot

**SECTION 608 -- SIDEWALKS****Description**

**1.1** This work shall consist of constructing sidewalks of either hot bituminous pavement, or Portland cement concrete, reinforced when specified. Portland cement concrete sidewalks shall receive a protective coating unless otherwise directed.

**1.2 Detectable Warning Devices.** This work shall consist of furnishing and installing a detectable warning surface and accessories on sidewalk ramps at locations shown on the plans, as specified herein, or as ordered including any and all required surface preparation. Detectable warnings shall be installed at sidewalk ramps where a sidewalk crosses a vehicular way, excluding unsignalized driveway crossings. Detectable warnings shall measure 24" in the direction of travel and extend the full width of the sidewalk ramp and the edge nearest the curbline shall be located 6 to 8" from the face of curbline.

**Materials**

**2.1** Base course materials shall conform to the class of materials as specified in the plans.

**2.2** Portland cement concrete shall be Class A conforming to [Section 520](#).

**2.2.1** Coarse aggregate shall be standard size #67.

**2.2.2** Protective coating shall be Silane/Siloxane conforming to [Section 534](#).

**2.3 Reinforcement.** Synthetic fiber reinforcement shall conform to [544.2.5](#).

**2.4** Joint filler shall conform to AASHTO M 213.

**2.5** Hot bituminous pavement shall meet the material requirements of [Section 401](#) except that the composition of mixtures shall conform to the limits of Table 608-1.

**Table 608-1 - Composition of Mixtures - Master Ranges English**

	Binder Course	Wearing Course
Sieve Size	Percentage by Weight Passing	
1/2"	95 – 100	---
3/8"	90 – 100	98 - 100
No. 4	45 – 75	80 - 100
No. 8	32 – 53	45 - 70
No. 16	22 - 41	30 - 51
No. 30	14 - 33	21 - 38
No. 50	8 - 25	13 - 27
No. 200	2 – 6	2 - 6
Asphalt Cement Percent of Mixture	5.5 - 7.5	6 - 9

**2.6 Detectable Warning Devices.**

**2.6.1** Detectable warning devices shall be gray cast iron conforming to AASHTO M105 and AASHTO M306.

**2.6.2** Cast iron panels shall have no surface coating, and shall be allowed to transition to their natural patina.

**2.6.3 Detectable Warning Panel Truncated Dome Geometry.**

**2.6.3.1** Detectable warning devices shall be in full compliance with ADA Accessibility Guidelines (ADAAG) (Title 49 CFR Transportation, Part 37.9 Standard for Accessible Transportation Facilities, Appendix A, Section 4.29.2 – Detectable Warning on Walking Surfaces).

**2.6.3.2** Size and spacing for truncated domes shall be as follows: base diameter of nominal 0.9", top diameter of nominal 0.4", height of nominal 0.2", with a center to center spacing of nominal 2.35".

**2.6.3.3** The truncated domes shall be arranged in a grid pattern and shall align properly from panel to panel.

## Construction Requirements

### 3.1 Bituminous Sidewalks.

**3.1.1 Subgrade and base course.** The subgrade shall be carefully graded and compacted. The base course material shall be spread and rolled to a smooth surface and to the required cross-section.

**3.1.2 General.** The plant, mixing methods, and hauling shall conform to the provisions of [Section 401](#).

**3.1.2.1** The compacted binder course shall be 1" less in thickness than the total thickness of the sidewalks.

**3.1.2.2** The compacted wearing course shall be 1" in thickness.

**3.1.3 Placing.** The bituminous pavement shall be spread uniformly in two courses as specified above. Each course shall be rolled with a roller weighing between 500 lb. and 2,000 lb. The finished surface shall be uniform in appearance, free from irregularities, and shall present a smooth surface. The edges shall be trimmed as directed.

**3.1.4 Backfilling.** The edges of the sidewalk shall immediately be backfilled as necessary with suitable material compacted and finished flush with the top of the sidewalk.

### 3.2 Concrete Sidewalks.

**3.2.1** Excavation shall be made to the required depth and to a width that will permit the installation and bracing of the forms. The foundation shall be shaped and compacted to a firm, even surface conforming to the section shown on the plans. All soft and yielding material shall be removed and replaced with acceptable material.

**3.2.2** Forms shall be of wood or metal and shall extend for the full depth of the concrete. All forms shall be straight, free from warp, and of sufficient strength to resist the pressure of the concrete without springing. Bracing and staking of forms shall be such that the forms remain in both horizontal and vertical alignment until their removal.

**3.2.3** The foundation and granite curb shall be thoroughly moistened immediately prior to the placing of the concrete. Any standing water shall be removed before the concrete is placed. The proportioning, mixing, and placing of the concrete shall be in accordance with 520.3.

**3.2.4 Reinforcement.** Reinforcing steel in reinforced concrete sidewalk shall be placed at mid-depth or as shown on the plans, using the methods described in 544.3. Synthetic fiber reinforcement shall be evenly distributed throughout using methods described in 544.3.

#### 3.2.5 Finishing.

**3.2.5.1** Concrete shall be finished by use of wood, or magnesium floats, by skilled concrete finishers. A fine-grained broom finish shall be applied to all concrete sidewalks subject to foot traffic.

**3.2.5.2** All outside edges and expansion or construction joints shall be edged with an edging tool having a radius of 1/4". All crack control joints in sidewalks subject to foot traffic shall be edged with a jointing tool.

#### 3.2.6 Joints.

**3.2.6.1** Construct transverse and longitudinal crack control joints by sawing, jointing tool or other approved method to a minimum depth of one third the slab thickness. If the jointing tool is not capable of constructing a joint to the correct depth, saw the joint to the correct depth. Saw crack control joints as soon as concrete has hardened sufficiently to permit sawing without excessive raveling and before uncontrolled shrinkage cracking occurs, usually between four and twenty four hours. Control joints for cracking shall be spaced at 8 ft. and 12 ft. for slab thickness of 4" and 6" respectively, unless otherwise specified. Form crack control joints every 5 ft. in sidewalks subject to foot traffic. Bond breaker shall be used at all construction joints.

**3.2.6.2** Expansion joints shall be formed at any angles or intersections in the sidewalks, around all appurtenances such as manholes, utility poles and catch basins, and between buildings or bridges. Preformed expansion joint filler of the thickness indicated shall be installed for the full depth of the slab.

**3.2.7 Curing.** Concrete shall be cured for a minimum of 7 days. Curing compounds will not be permitted unless otherwise approved. Plastic sheets or other approved materials shall be placed in close contact with the finished concrete as soon as the concrete has set sufficiently to avoid damage from the placement of coverings. The protective covering shall be maintained vapor-proof in close contact with the concrete for the entire 7 day period unless otherwise approved. All traffic shall be excluded during the curing period. Vehicular traffic shall be excluded for such additional time as ordered.

**3.2.8 Protective coating.** Protective coating shall be applied in accordance with [534.3](#).

### 3.3 Detectable Warning Devices.

**3.3.1** The Contractor shall submit manufacturer's descriptive literature for materials specified in accordance with [105.02](#).

## SECTION 608

- 3.3.2 Transport, storage, and handling of products shall be in accordance with manufacturer's instructions.
- 3.3.3 Install detectable warning devices and any anchoring hardware in accordance with manufacturer's instructions. Panels shall be set into a bed of 4" wet unreinforced concrete.
- 3.3.4 Use a combination of available panel widths as manufactured to cover the full sidewalk ramp width to the extent practicable. Field cutting of panels is not permitted.
- 3.3.5 Care shall be taken to ensure the safety of pedestrians when sidewalks must remain in service during construction.

### Method of Measurement

- 4.1 Sidewalks will not be measured, but shall be the square yard final pay quantities in accordance with 109.11 for sidewalks required as shown on the plans. The area occupied by the curb will not be included in the final pay quantity.
  - 4.1.1 Protective coating will not be measured.
- 4.2 Base course material will be measured by the cubic yard determined by the product of the area and depth of sidewalk approved for payment shown on the plans or ordered.
- 4.3 Detectable Warning Devices will be measured by the square yard to the nearest 0.1 of a square yard.

### Basis of Payment

- 5.1 Sidewalks are final pay quantity items and will be paid for at the Contract unit price per square yard complete in place in accordance with 109.11.
  - 5.1.1 Protective coating for concrete sidewalks will be subsidiary.
- 5.2 Base course material will be paid for as shown on the plans.
- 5.3 Necessary excavation will be paid for under Section 203.
- 5.4 Detectable Warning Devices will be paid for at the Contract unit price per square yard complete in place including accessories, anchoring hardware and any required surface preparation.

### Pay items and units:

608.1	_in Bituminous Sidewalk (F)	Square Yard
608.2	_in Concrete Sidewalk (F)	Square Yard
608.3	_in Reinforced Concrete Sidewalk (F)	Square Yard
608.54	Detectable Warning Devices, Cast Iron	Square Yard

**SECTION 609 -- CURBS****Description**

1.1 This work shall consist of constructing or resetting curbs as shown on the plans or as ordered.

**Materials**

2.1 Curb shall be new granite, salvaged granite, or bituminous, as indicated in the proposal.

2.2 Granite shall be hard, durable, reasonably uniform in appearance, and free from weak seams. Solid quartz or feldspar veins will not be cause for rejection.

2.2.1 Surfaces of each stone shall be finished in accordance with the requirements of Table 609-1. All comparable curbs on the project shall have similar finishes.

2.2.2 When the slope curb item description does not indicate a specific height, the size of the stone shall be as shown on the standard entitled "Granite Slope Curb". The setting reveal (the vertical height of the exposed face when set) shall be 4" or as shown on the plans.

2.3 Salvaged granite curbing shall be dressed to obtain joints of the same width as specified for new curb.

**Table 609-1**  
**Finished Surfaces and Tolerances for Granite Curbing**

Type	Area	Finished Surface	Tolerance, Inches <sup>a</sup>	
<b>Straight or Curved</b>	Top	5" wide or as otherwise shown, sawn true plane.	+1/8	-1/8
		Front and back arris lines pitched straight and parallel.	+1/8	-1/8
	Front face	Right angle to top, approximately true plane. No drill holes showing in top 10".	+1	-1/2
	Back face:			
	Exposed	Plane parallel with front face. Straight split to 1-1/2" below exposed surface. No larger than 1/4" segment of drill holes showing in arris lines.	+1	-1
	Concealed	Below 1-1/2" from exposed surface.	+1-1/2	-1-1/2
	Bottom	Approximately parallel to top. Minimum width: 3"	See plans.	
	Ends:			
	Exposed	Square with planes of top and face.		
	Joints:			
	Exposed	Optimum width: 1"		
	Concealed	To break back no more than 4"	+3/4	-3/4
	Lengths of stones	3 to 10 ft. with 50 percent of sections to be 5 ft. or greater, or as indicated.		

**SECTION 609**

Type	Area	Finished Surface	Tolerance, Inches <sup>a</sup>	
<b>Bridge</b>		Conform to Straight Curb except as specified below.		
	Exposed surfaces	No drill holes showing; none in back face arris lines.		
	Bottom	Width equal to width of top.	+1/2	-1/2
	Joints:			
	Exposed	Maximum width: 1/2"	+1/4	
	Concealed	Split face to break back no more than 1"		
<b>Slope and End Stone</b>	Arris lines	Straight and true on top, front and ends. Drill holes not deeper than 1/4" allowed in arris lines.	+1/4	-1/4
	Faces:			
	Exposed	Planes; no drill holes in faces longer than 8" or deeper than 1/4"	+1	-1
	Concealed	Drill holes not objectionable.		
	Ends	Square with face except as indicated.		
	Joints	On tangent, maximum width: 1" On curves over 15 ft. radius, widen top or bottom from 1" as necessary.	+1/2	-1/2
		On curves with 15ft. radius and under, use radial joints or curved curb as indicated. Optimum width: inch	+1/2	-1/2
Length of stones	Min. and max. specified lengths.	See plans.		

<sup>a</sup> + Projection in stone; -Depression in stone

**Table 609-2 - Required Grading For Bituminous Curb**

Sieve Size	Percentage by Weight Passing
3/4"	100
1/2"	86.0 - 100
3/8"	75.0 - 100
No. 4	60.0 – 80.0
No. 8	42.0 – 62.0
No. 16	30.0 – 49.0
No. 30	22.0 – 39.0
No. 50	14.0 – 27.0
No. 200	3.0 – 10.0
Asphalt Cement, percent of Mix	7.0 - 9.0

**2.4** Bituminous curb shall meet the requirements of [Section 401](#) except that the composition of the mixture shall conform to the limits of Table 609-2. The mixture shall extrude properly with a uniform, smooth appearance.

**2.4.1** Polyester fibers, as included on the [Qualified Products List](#), shall be uniformly incorporated in the dry mix in the proportion of approximately 1/4 percent of the total batch weight.

**2.4.2** Curb paint shall be Ready-Mixed White or Yellow Traffic Paint in conformance with either 708-NH 4.11 or 708-NH 4.12, respectively.

**2.4.3** Beads for reflectorization shall conform to [Section 708](#).



2.5 Cement mortar shall conform to [Section 707](#) except that cement mortar for bedding curb (bridge) shall be an approved non-shrink, non-metallic grout mixed as recommended by the manufacturer. The non-shrink, non-metallic grout shall be a product as included on the [Qualified Products List](#). When the bedding is more than 3/4" in height, a 3/8" washed stone may be mixed into the mortar at the maximum of 1 part stone to 4 parts dry mortar.

2.6 Curb anchors shall be zinc-coated (galvanized) steel in accordance with ASTM A 653, coating designation G 90 of shapes and dimensions as shown on the plans.

2.7 Backfill material shall conform to the appropriate material shown on the plans.

### Construction Requirements

#### 3.1 Granite Curb.

3.1.1 Excavation for curb shall be made to the required depth, and the base upon which the curb is to be set shall be compacted to a firm even surface.

3.1.2 Installation of curbing shall be so that the front top arris line conforms to the line and grade required. All spaces under the curbing shall be filled with material conforming to the requirements for roadway base course. This material shall be thoroughly tamped.

3.1.3 Joints shall be of the width indicated in [Table 609-1](#). They shall be pointed with mortar and the exposed portions finished with a jointer.

3.1.4 Backfilling shall be accomplished immediately after the curb is set and jointed. Backfill shall be of approved material, placed and thoroughly tamped.

3.1.4.1 Concrete Class A in accordance with [Section 520](#) may be substituted for aggregate base course and hot bituminous base courses in the curb patch on the roadway side of granite curb. Concrete thickness shall be not less than that of the adjacent pavement.

3.1.5 Bridge curb shall be set on a mortar bed of non-shrink, non-metallic grout. The front face shall be plumb and the top shall conform to the required line and grade. All joints shall be grouted and the exposed portions finished with a jointer. Long and short lengths of curb shall be laid alternately unless otherwise ordered.

3.1.5.1 Curb anchors shall be set and grouted as shown on the plans.

#### 3.2 Bituminous Curb.

3.2.1 Prior to placing the curbing, the surface of the pavement shall be cleaned as directed and painted with a tack coat of bituminous material when ordered.

3.2.2 The curbing shall be placed by means of an approved extruding curb paver. The curbing shall be compacted to a minimum density of 90 percent of a laboratory compacted sample of the same mix. A tight bond shall be obtained between the prepared course and the curb and between necessary curb joints.

3.2.3 When painted curb is specified, the exposed surfaces of the curbing shall be painted with two coats of curb paint in accordance with the paint manufacturer's recommendations after a curb curing period that shall be as long as project conditions permit, but no sooner than seven days. Primer and finish coats shall be applied at a rate to obtain a wet thickness of 16 mils each application. The finish coat is intended to serve as the vehicle for holding the beads for reflectorization.

3.2.4 The beads for reflectorization shall be applied by the drop-on method at the time of application of the second coat of paint, evenly and uniformly, at the rate to obtain the adhesion of the maximum number of beads possible. Dead spots found upon testing after dark shall be repainted and additional beads applied.

#### 3.3 Reset Granite Curb.

3.3.1 Curbing to be reset shall be carefully removed and stored. The Contractor shall replace any curbing damaged or lost because of his negligence. All exposed portions of reset curbing shall be cleaned by sand blasting.

### Method of Measurement

4.1 Curb will be measured by the linear foot to the nearest 0.1 of a foot from end to end along the lower edge of the exposed face of the curbing. Only curbing actually cut to a radius will be considered as curved curb. Slope curb shown or ordered to be cut on radial joints, (not square with face) will be measured separately.

4.1.1 No separate measurement will be made for storage if necessary or sandblasting of reset curb.

4.1.2 Curb for salvage shall be as provided for in [Section 202](#).

## SECTION 609

### Basis of Payment

**5.1** The accepted quantities of curb will be paid for at the unit price per linear foot for each type of curbing specified, complete in place, except that all special cutting ordered due to changes in the plans will be paid for as provided in [109.04](#).

**5.2** Roadway base course material adjacent to the curb will be paid for under the appropriate items and no deduction will be made for the volume occupied by the curb. In the process of setting the curb, excavation and backfill of the material that has been placed by the Contractor will be considered as incidental to the item.

**5.3** Hot bituminous base courses placed adjacent to the curb for a maximum width of 1 ft. will be paid for under Item 403.12. Concrete Class A substituted for aggregate base course and hot bituminous base courses will be paid for under Item 403.12 at 2.0 tons per cubic yard.

#### Pay items and units:

609.01	Straight Granite Curb	Linear Foot
609.02	Curved Granite Curb	Linear Foot
609.21	Straight Granite Slope Curb	Linear Foot
609.21_	Straight Granite Slope Curb _inch High	Linear Foot
609.22_	Straight Granite Slope Curb with Radial Joints	Linear Foot
609.22_	Straight Granite Slope Curb with Radial Joints _in High	Linear Foot
609.23	Curved Granite Slope Curb	Linear Foot
609.23_	Curved Granite Slope Curb _inch High	Linear Foot
609.3	Straight Granite Curb (Bridge)	Linear Foot
609.311	Straight Granite Curb (Bridge), Modified	Linear Foot
609.35	Curved Granite Curb (Bridge)	Linear Foot
609.5	Reset Granite Curb	Linear Foot
609.51	Setting Granite Curb Furnished by Others	Linear Foot
609.55	Reset Granite Curb (Bridge)	Linear Foot
609.811	Bituminous Curb, Type B 4" Reveal	Linear Foot
609.812	Bituminous Curb, Type A	Linear Foot

**SECTION 614 -- ELECTRICAL CONDUIT****Description**

**1.1** This work shall consist of furnishing, installing and testing conduit of the size and type specified, including sweeps, bends, joints, hangers, pull boxes, special fittings, plastic warning tape and other appurtenances, as shown on the plans or ordered. Sawed pavement, common structure excavation to the depth specified in [206.4.1](#), bedding if required, and backfill shall be included in this work. This work shall also include the disposal of discarded materials and the restoration of disturbed surfaces when not otherwise included under other items in the Contract.

**Materials**

**2.1** Steel conduit and steel conduit for sleeves shall conform to ASTM A 53 Standard Weight and shall be galvanized unless otherwise specified.

**2.2 Plastic Conduit.**

**2.2.1** Electrical plastic tubing (EPT) and electrical plastic conduit (EPC) including fittings and joint shall be made from polyvinyl-chloride (NEC 352) or polyethylene (NEC 353) and shall conform to NEMA TC 2 or NEMA TC 7. Conduit shall be marked in accordance with NEMA TC 2-6.1.

**2.2.2** Only water tight fittings supplied or recommended by the manufacturer shall be used.

**2.2.3** When the item description calls for Plastic Conduit (material is not specified) either PVC or polyethylene shall be furnished and shall meet the requirements of 2.2.1.

**2.3** Concrete for cast in place conduit encasement shall conform to [Section 520](#), Class B. Precast concrete encased conduit will not be permitted.

**2.4** Plastic warning tape shall be American Public Works Association standard 6" wide polyethylene color coded and marked in accordance with the utility industry standards for marking underground utility lines.

**2.5** Concrete pull boxes, either precast or cast in place, shall be constructed using concrete conforming to [Section 520](#), Class A and designed for AASHTO H20 loading. Frame and cover castings shall be gray iron conforming to AASHTO M 105. Unless otherwise specified, all gray iron castings shall be Class 30. Covers shall be secured to the frame with two stainless steel hex head bolts conforming to ASTM A 240 Type 304. Pull boxes and covers shall be constructed as detailed on the plans.

**2.6** Molded pull boxes shall be either fiberglass-filled high density polyethylene (HDPE), fiber reinforced polyester mortar, or fiberglass cloth reinforced polymer concrete, all with high impact resistance, ultraviolet stabilization tested per ASTM G53 and Chemical resistant tested per ASTM 543 section 7. The box and cover shall be designed for off roadway applications subject to incidental, non-deliberate heavy vehicular traffic in accordance with the Western Underground Committee Guide 3.6 for non-concrete enclosures (WUC Guide 3.6). Boxes and covers shall be tested with the cover in place.

**2.6.1** The cover shall withstand a vertical test load of 20,800 lb. applied at the center of the cover, by a 10" x 10" plate, with less than 1/2" deflection over 10 test cycles. The boxes shall withstand a vertical box wall test load of 20,800 lb. applied by a 10" x 10" plate with a 5" x 10" area centered on the long wall with no more than 1/4" deflection per foot of length of enclosure over 10 test cycles. Boxes shall also withstand a lateral sidewall test load of 1,200 lb. per square foot applied by a plate 24" by the depth of the box, with no more than 1/4" deflection per foot of length of enclosure over 10 test cycles. Tested in accordance with Section 4.1 of WUC Guide 3.6. Permanent deflection of any surface shall not exceed 10 percent of the maximum allowable static test load deflection.

**2.6.2** Enclosures shall be designed and suitable for installation and use through a temperature range -40° F to 195° F

**2.6.3** Covers, boxes and extensions shall meet the acceptance criteria in accordance with Section 5.3 of WUC Guide 3.6. A spray or paint covering shall not be used to achieve the required nonflammability.

**2.6.4** Boxes and extensions shall have adequate soil bearing surface to prevent settling in any soil, when tested in accordance with Section 4.1 of WUC Guide 3.6.

**2.6.5** Covers and extensions shall be interchangeable with other boxes of the same material type and size manufactured to WUC Guide 3.6.

**2.6.6** Any point on the covers shall withstand a 70 lb(f)-ft. impact administered with a 12 lb. weight using a "C" TUP (ASTM D-2444) without puncturing or splitting. The test shall be performed with the cover resting upon a flat, rigid surface such as concrete or a 1" steel plate.

**2.6.7** Cover surface shall provide a minimum coefficient of friction of 0.50. Covers shall be secured to box with two hex-head stainless steel bolts conforming to ASTM A 240 Type 304. Bolts shall be self-retaining and shall withstand a minimum of

## SECTION 614

70 lb(f)-ft. torque and have a minimum of 750 lbs straight pull out strength. Nuts shall be floating, replaceable and in a nut cavity which is free draining and shall provide a minimum of 1/2" movement from the center of the nut.

**2.6.8** A Certificate of Compliance that the enclosure meets the above requirements when tested in accordance the Western Underground Committee Guide 3.6 testing procedures by a nationally recognized independent testing laboratory shall be provided.

### Construction Requirements

#### 3.1 General.

**3.1.1** Installations within the limits of the traveled way and shoulders, whether paved or unpaved, shall be constructed with Schedule 80 plastic conduit (EPC), rigid steel conduit, or concrete encased Schedule 40 plastic conduit (EPC).

**3.1.2** Installations beyond the limits of the traveled way and shoulders shall be constructed with Schedule 80 plastic conduit (EPC), Schedule 40 plastic conduit (EPC), or rigid steel conduit. These materials may also be used under sidewalks and parking lots subject to incidental heavy vehicular activity.

**3.1.3** Sawed pavement shall conform to [628.3.4](#).

#### 3.2 Bedding.

When conduit is installed within traveled ways, shoulders, sidewalks and parking areas, the backfill shall be placed to 6" above the conduit or encasement and compacted by pneumatic tampers, vibratory compactors, or other approved means. Additional backfill shall be placed in layers not greater than 6".

#### 3.3 Laying.

**3.3.1** Conduit shall be laid to a pitch of not less than 3" per 100 feet.

**3.3.2** All conduit lines located under pavement shall be installed in a straight line. Field bends required in other areas shall be made with an approved conduit bender. Not more than four 90 degree bends or equivalent (360 degree total) shall be used on a continuous conduit line. Bending radius shall not be less than 30 ft. unless otherwise directed. Bends in conduit entering pull boxes, light pole bases, signal and meter pedestal bases, transformer pads, signal controller bases and at risers shall be made with manufactured electrical standard elbows.

**3.3.3** All conduit connections shall be waterproof and conform to NEMA TC 2-3.4. When conduit of one material is to be joined to an existing conduit of another material, weatherproof adapters manufactured for the purpose shall be used. Waterproofing and sealing compounds containing bituminous material shall not be used.

**3.3.4** When conduits are encased in concrete, concrete cover around ducts shall be a minimum of 3" with a minimum separation of 1-1/2" between ducts unless otherwise specified or ordered. After the initial set, the concrete shall be protected from the air and sun. Fill shall not be placed over the conduit until authorized by the Engineer.

**3.3.5** Conduit risers installed on poles or other structures shall extend a minimum of 10 ft. above the elbow and be of a type and total height to meet utility company requirements. Conduits shall be attached with an approved support strap. A suitable plug shall be installed in the end of the conduit riser.

**3.3.6** When ordered, conduit shall be placed under existing pavement by approved jacking or drilling methods which do not disturb the pavement. Pavement shall not be disturbed without the written permission of the Engineer. Jacking and drilling pits shall be kept 2 ft. clear of the edge of pavement.

**3.3.7** When so directed, and whenever a continuous traffic signal conduit line is greater than 90 ft., additional pull boxes shall be installed. Cable splices shall not be made in these boxes without permission.

**3.3.8** A minimum of 3 ft. of space shall be left between the ends of conduit runs where there may be a future junction. When conduit is installed which does not terminate in a pull box, equipment base or similar type foundation, a witness marker consisting of a No. 5 re-bar of sufficient length to allow for the top of the marker to be set flush with the final grade shall be placed vertically at each end of such buried conduit.

**3.3.9** Unless otherwise directed, a 14 gauge galvanized steel pull wire or plastic/nylon rope having a minimum tensile strength of 200 lb, shall be placed in all conduit runs. At least 24" of wire or rope shall be left coiled at each end of the conduit.

**3.3.10** Brackets or spacers/separators for hanging and/or bundling ducts shall be as shown in the plans or approved by the Engineer.

**3.3.11 Various Size Duct Conduit.** The configuration of the multiple sized conduits shall be in accordance with the details shown in the plans.

### 3.4 Backfilling.

**3.4.1** All backfill material adjacent to conduit shall be approved material. Backfill material shall be free from hard lumps or clods larger than 3" in diameter and free from rocks and stumps. Backfill within the pavement structure shall be of the same type material and match the depths encountered.

**3.4.2** When conduit is installed beyond traveled ways and shoulders, and outside of areas such as sidewalks and parking lots, the backfill shall be placed to 6" above the conduit and compacted by pneumatic tampers, vibratory compactors, or other approved means. The remainder of the backfill material shall then be placed and compacted by an approved method.

**3.4.3** When conduit is installed within traveled ways, shoulders, sidewalks and parking areas, the backfill shall be placed to 6" above the conduit or encasement and compacted by pneumatic tampers, vibratory compactors, or other approved means. Additional backfill shall be placed in layers not greater than 6".

**3.4.4** Bituminous or Portland cement concrete pavement removed to excavate the trench shall be replaced with hot bituminous pavement conforming to the requirements of [Section 401](#) unless otherwise directed. Pavement shall be placed in thoroughly compacted layers of not more than 2" to give a total thickness equal to that of the existing pavement. All backfill shall be compacted to not less than 95 percent of maximum density as determined by AASHTO T 99.

**3.4.5** Conduits provided for future use shall have suitable plugs installed at each end. Conduit ends shall not be backfilled until reference measurements are made by the Engineer.

**3.4.6** A plastic warning tape shall be installed over all conduits at approximately 12" below final grade.

### 3.5 Testing.

**3.5.1** After the trench has been backfilled, excluding pavement if applicable, the Contractor, in the presence of the Engineer, shall test the installation by pushing through the entire length of the conduit line a device with a diameter not smaller than 1/4" less than the inside diameter of the conduit. All obstructions including stones, dirt, and the like, shall be removed. Broken or other unsatisfactory conduits shall be replaced at no expense to the Department.

**3.5.2** When ordered, existing conduit to be incorporated into a new system shall be cleaned with a mandrel and blown out with compressed air.

### 3.6 Pull Boxes.

**3.6.1** Pull boxes within the limits of the traveled way, shoulders, whether paved or unpaved, parking lots, adjacent to slope curb, and within 10 ft. of the edge of pavement shall be concrete and installed as shown on the plans and specified herein.

**3.6.2** Pull boxes outside the limits of 3.6.1 shall be concrete or molded and installed as shown on the plans and specified herein.

**3.6.3** All pull boxes shall be placed on a minimum of 6" of Granular Backfill conforming to [209.2.1](#) extending at least 4" beyond the outside of the pull box compacted to not less than 95 percent of maximum density as determined by AASHTO T 99. With the cover installed, soil shall be backfilled and compacted around the box. At final installation the box and cover shall be flush with finished grade.

**3.6.4** Pullbox covers shall have a recessed logo indicating the type of service enclosed.

**3.6.5** An approved 2" galvanized "J" hook shall be installed as directed in pull boxes designated to be used for traffic signal circuits.

#### Method of Measurement

**4.1** Conduit will be measured by the linear foot of the specified type, size and number of ducts of the size required, to the nearest 0.1 of a foot. Multiduct conduit will be measured as a single run down the centerline of the conduit bundle.

**4.1.1** When a conduit is connected to a foundation for a signal pole, control cabinet pole, or light pole, measurement will be made only to 3 ft. from the center of the base, measured horizontally. The limit of measurement where conduit is joined to previously existing conduit will be at the junction of the two conduits.

**4.2** Pull boxes will be measured by each, but will not be deducted from the length of the conduit.

#### Basis of Payment

**5.1** The accepted quantities of conduit will be paid for at the Contract unit price per linear foot of the type, size and number of ducts specified complete in place, including brackets/spacers, sawed pavement, common structure excavation to the depth specified in [206.4.1](#), bedding if required, and backfill, with the following exceptions:

## SECTION 614

**5.1.1** All rock structure excavation, any common structure excavation below the depth specified in [206.4.1](#), and any excavation of unsuitable material required below the conduit will be paid for under [Section 206](#).

**5.1.2** New material ordered for use as backfill below the subgrade to replace rock structure or unsuitable excavation will be paid for under [Section 209](#).

**5.1.3** Hot bituminous pavement required in 3.4.4 will be paid under [Section 403](#). If the item of 403 is not included in the Contract, this work will be paid as provided in [109.04](#).

**5.2** The accepted quantities of pull boxes of the type specified will be paid for at the Contract unit price per each.

**5.2.1** No extra payment will be made for material specified in 3.6.3.

### Pay items and units:

.	A	B	C	D	E	Linear Foot
	A	Conduit Type				
	1	Concrete Encased				
	2	Open				
	3	Steel Conduit				
	8	Relaying Conduit				
		B	Size	(round up to nearest whole number)		
		9	9" and over Duct			
		0	Various Sizes in Multi Duct			
			C	Number of Ducts		
.	5	Pull Boxes				Each
		B	Box Type			
		1	Concrete			
			1	14"		
			2	18"		
		2	Molded			
			2	13 by 24"		
			3	17 by 30"		
.	7	Plastic Conduit				Linear Foot
		B	Size	(round to nearest whole number)		
		0	Various Sizes in Multi Duct			
			C	Number of Ducts (10 and over use 0)		
			D	Schedule		
				4 Schedule 40		
				8 Schedule 80		
			E	Plastic Conduit Material		
				1 PVC		
				2 Polyethylene		

**SECTION 615 -- TRAFFIC SIGNS****Description**

**1.1** This work shall consist of furnishing, erecting, relocating or removing traffic signs and sign supports as shown on the plans or as ordered.

**1.2 Sign Types.**

**1.2.1** Traffic Signs Type A and Type AA shall be extruded aluminum plank traffic signs with retroreflective sheeting background and retroreflectorized demountable cut-out copy. Type A shall include W-beam mounts and hardware as shown on the plans.

**1.2.2** Traffic Signs Type B and Type BB shall be flat sheet aluminum signs with retroreflective sheeting background and retroreflectorized cut-out copy or overlay film. Type B shall include aluminum tube mounts or steel “U” post mounts or as shown on the plans.

**1.2.3** Traffic Signs Type C and Type CC shall be flat sheet aluminum signs with retroreflective sheeting background and non-embossed copy unless otherwise shown on plans. Type C signs shall include aluminum tube mounts or steel “U” post mounts or as shown on the plans.

**Materials**

**2.1** All parts used in constructing signs shall be designed to withstand a wind loading of 35 pounds per square foot on the sign surface, unless otherwise noted on the plans.

**2.2 Plank Signs.**

**2.2.1** Extruded aluminum planks shall be of the butt type, 6 or 12” wide and of the lengths indicated on the plans. Edge moldings are optional and if furnished shall match the panels and shall have a natural aluminum finish. Aluminum panels shall conform to the requirements of ASTM B 221, Alloy 6061-T6. Aluminum molding may be of T5 or T6 temper.

**2.3 Sheet Signs.**

**2.3.1** Flat aluminum sheets for sheet signs shall be one piece and conform to ASTM B 209, Alloy 6061-T6 or Alloy 5052-H38. The minimum thickness of the sheets up to 36” wide shall be 0.080” Signs greater than 36” shall be a minimum of 0.100”.

**2.3.2** Plywood sheet signs shall be standard form (BB grade or better), minimum 0.5”, exterior type with both faces of medium density overlay (MDO) as described in Voluntary Product Standard “PS-1-95 Construction and Industrial Plywood”, National Institute of Standards & Technology. The edges of the plywood signs shall be sealed by painting them with a sealer.

**2.4 Blank.****2.5 Vertical Supports.**

**2.5.1** Steel posts shall conform to ASTM A 36 or ASTM A 572 and unless otherwise shown on the plans, shall be galvanized in accordance with AASHTO M 111 (ASTM A 123).

**2.5.1.1** The total maximum weight of steel posts below the hinges of a breakaway support system shall not exceed 45 pounds per foot when 2 posts are to be placed within 7 ft. of each other.

**2.5.1.2** Overhead traffic sign structures shall be galvanized steel designed in accordance with 3.4.1.

**2.5.2** Aluminum posts for non-breakaway supports shall be of a standard shape aluminum tubing conforming to ASTM B 221, Alloy 6061-T6 or 6063-T6, as shown on the plans. The wall thickness shall be a minimum of 1/8” and a maximum of 3/16”.

**2.5.2.1** Aluminum posts for use with breakaway support systems shall conform to ASTM B 429, Alloy 6061-T6 or 6063-T6, Schedule 40, as shown on the plans.

**2.5.3** Steel “U” posts shall be rail steel conforming to the requirements of ASTM A 499, Grade 60 or ASTM A 576, Grade 1070-1080, minimum yield strength of 60,000 psi. Posts shall be galvanized in accordance with AASHTO M 111. The weight per foot shall be a minimum of 2-1/2 lb. and a maximum of 3 lb. The posts shall have 3/8” holes drilled or punched, before painting, along the center line of the web. The holes shall begin 1” from the top of post and continue at 1” centers for the entire length of the post.

**2.6 Blank.****2.7 Hardware.**

**2.7.1** Hardware for signs shall conform to the [NHDOT Standard Plans](#).

## SECTION 615

**2.7.2** The extruded plank post clip assembly shall be stainless steel bolt Alloy 304 ASTM A 193/ASTM A193M Grade B8, stainless steel stop nut Alloy 304 ASTM A-194 Grade 8 with nylon filler and stainless steel M10 flat washer Alloy 302 ASTM – A 276.

**2.7.3** The extruded plank attachment assembly shall be stainless steel hex bolt Alloy 304 ASTM A193 Grade B8, stainless steel hex nut Alloy 304 ASTM A-194 Grade 8 and stainless steel M10 flat washer Alloy 302 ASTM-A276.

**2.7.4** The bolt assembly for the post clamp shall be stainless steel cap screw Alloy 304 ASTM A193 Grade B8, stainless steel locknut Alloy 304 ASTM A194 Grade 8 with nylon filler and stainless steel M10 flat washer Alloy 302 ASTM-A276. The finish on the clamps shall be Electro-Galvanized clamp. Hardware shall be Unistrut P1120 EG or approved equal. The channel bracket shall be pregalvanized conforming to ASTM D653 G90, and steel conforming to ASTM A653 GR 33 without perforations. Hardware shall be Unistrut P4100 PG or approved equal.

**2.7.5** The U-channel post assembly shall be stainless steel hex bolt Alloy 304 ASTM A193 Grade B8, stainless steel M10 fender washer and flat washer Alloy 302 ASTM-A276, a nylon washer, and stainless steel locknut Alloy 304 ASTM A194 Grade 8 with nylon filler.

### 2.8 Supports, Bases, and Anchors.

**2.8.1** Breakaway support systems shall conform to the AASHTO “ Standard Specifications for Structural Supports for Highway Traffic Signs, Luminaires and Traffic Signals” as shown on the plans.

**2.8.2** Concrete for bases shall be Class B and shall conform to [Section 520](#). Reinforcing steel shall conform to [Section 544](#).

**2.8.3** Anchor bolts for overhead sign structure shall be steel conforming to AASHTO M 314, Grade 36, 55 or 105 and shall be hot-dip galvanized for a minimum of 16” on the threaded end in accordance with AASHTO M 232, Class C. Nuts shall conform to AASHTO M 291. Washers shall conform to AASHTO M 293. Nuts and washers shall be galvanized in accordance with AASHTO M 232, Class C or AASHTO M298, Class 50.

**2.8.4** Anchors for aluminum posts shall conform to the materials shown in the [NHDOT Standard Plans](#).

**2.8.5** Anchors for breakaway systems for ground-mounted sign supports shall be stainless steel Type 304 in accordance with ASTM A 276. Anchor bolts for breakaway systems shall be steel in accordance with AASHTO M 164, galvanized in accordance with AASHTO M 232, Class C or AASHTO M 298, Class 50.

### 2.9 Copy (Text and Borders).

#### 2.9.1 General.

**2.9.1.1** The design, arrangement, color, and spacing of copy shall be as shown on the plans, in the MUTCD and the Standard Highway Signs book.

**2.9.1.2** There shall be no gaps in the borders of the signs.

**2.9.1.3** Demountable sign copy shall conform to ASTM B 209, Alloy 3003-H14. The minimum thickness of flat sheet aluminum shall be 0.032”.

#### 2.9.2 Copy for Type A, and Type AA Signs.

**2.9.2.1** The letters, numerals, symbols, shields, and borders of retroreflective sheeting permanently adhered to flat sheet aluminum backing shall be adhesive coated retroreflective sheeting conforming to 718 Retroreflective Sheeting.

**2.9.2.2** Spacing of mounting holes for demountable copy shall be determined by character size and shape, but in no case shall be more than 8” on center.

#### 2.9.3 Copy for Type B and Type BB Signs.

**2.9.3.1** The letters, numerals, symbols, shields, and borders of retroreflective sheeting shall be cut-out adhesive coated retroreflective sheeting conforming to [718 Retroreflective Sheeting](#).

#### 2.9.4 Copy for Type C and Type CC Signs.

**2.9.4.1** Copy for Type C and Type CC signs shall be cut-out or silk screened. Cut –out copy or ink for the silk screened shall be approved by background retroreflective sheeting manufacturer for use on its sheeting.

### 2.10 Background.

#### 2.10.1 Type A, AA, B, C and CC signs.

**2.10.1.1** All background sheeting shall be retroreflective sheeting conforming to [718 Retroreflective Sheeting](#). Visual inspections to assure that sheeting meets the specified requirements may be made by the Engineer at any time prior to acceptance.



**2.10.1.2** Certificates of Compliance for all sheeting materials shall be furnished in accordance with 106.04 and Section 718.

### Construction Requirements

#### 3.1 General.

**3.1.1** The plans will show cross sections of the highway in the area of overhead structures, the dimensions of the signs to be mounted, and the approximate locations, but the exact locations shall be as determined by the Engineer.

**3.1.2** The length of vertical supports may vary from the plan length to fit the final designed sign location and the Contractor is cautioned to take this contingency into account.

**3.1.3** Traffic sign details not shown on the plans shall conform to the MUTCD and Standard Highway Signs book. Traffic sign supports and framing members shall be in accordance with the AASHTO “Standard Specifications for Structural Supports for Highway Signs, Luminaires and Traffic Signals”.

#### 3.2 Manufacture and Assembly.

**3.2.1 Preparation of planks.** Prior to application of the retroreflective sheeting, planks shall have been completely fabricated with all necessary holes drilled or punched. The planks shall be carefully and thoroughly degreased and dried in accordance with the sheeting manufacturer’s recommended practice.

**3.2.2 Preparation of aluminum sheets.** Prior to the application of the retroreflective sheeting, the aluminum sheets shall be one piece except as indicated in 3.2.2.2 and have been cut to the required sizes, with the corners at the prescribed radii, with true and smooth edges, and shall be free of burrs or ragged breaks.

**3.2.2.1** The aluminum shall be properly degreased and etched or treated in accordance with ASTM B 449, Class 2.

**3.2.3** The retroreflective sheeting shall be of the colors provided in the MUTCD, Standard Highway Signs book, [NHDOT Standard Plans](#) or as shown on the plans.

**3.2.4** The Contractor shall submit drawings for approval showing arrangements, spacing, radii, border widths, indent spacing and colors of copy and type of retroreflective sheeting in accordance with 105.02.

**3.2.5 Application of retroreflective sheeting to aluminum plank.** The sheeting shall be applied to the face of the extruded aluminum planks by a squeeze roller applicator in accordance with the recommendations of the sheeting manufacturer. The face of the planks shall be completely covered by the retroreflective sheeting. Borders of pressure-sensitive adhesive type retroreflective sheeting shall be applied by means of a 2” rubber hand roller as recommended by the sheeting manufacturer. All signs shall contain the date of manufacture and size, located in the lower left corner of the front face of the sign (i.e. 3-90 10’x15’). Letters and numbers shall be 2” non-reflective white adhesive pressure copy.

**3.2.5.1** Whenever a sign face comprises two or more pieces of retroreflective sheeting, they shall be carefully matched for color at the time of sign fabrication to provide uniform appearance and brilliance both day and night, and shall have a minimum overlap of 3”. Alternate, successive width sections of either sheeting or planks shall be reversed and placed consecutively to ensure that corresponding edges of retroreflective sheeting lie adjacent on the finished sign.

**3.2.6 Application of retroreflective sheeting to aluminum sheets.** The sheets shall conform to the provisions of aluminum plank except that the sheeting shall be applied to the aluminum either by the heat vacuum applicator method or by mechanical roller application in accordance with the recommendations of the sheeting manufacturer and shall have a minimum overlap of 1” with the top sheeting overlapping the bottom sheeting. All Type B signs shall contain the date of manufacture and size, located in the lower left corner of the front face of the sign (i.e. 3-90 10’x15’). Letters and numbers shall be 1” non-reflective white adhesive pressure copy. All Type C signs shall contain a legible size and date of manufacture, located in the lower right corner on the back of the sign, applied with permanent marker or paint (i.e. 9-04, 3’x3’).

#### 3.2.7 Application of Sign Copy.

**3.2.7.1** Application of copy for Type A and Type AA shall be retroreflectorized demountable sign copy and shall be applied to the panels by using aluminum rivets or aluminum alloy sheet metal screws conforming to ASTM B 211, Alloy 2024. Screws and rivets are to be the same color as the sign copy. Silver can be used for white sheeting.

**3.2.7.2** Application of copy for Type B and Type BB traffic signs shall be adhesive back pressure sensitive cut-out copy applied by a roller application (hand or machine).

**3.2.7.3** Application of copy for Type C and Type CC traffic signs shall be cut-out or silk screened as specified by the sheeting manufacturer. Non-adhesive cut-out copy shall be bonded to the sign surface by the heat vacuum applicator method.

**3.2.8 Appearance.** Any damage to the retroreflective sheeting appearing in the completed sign shall be cause for rejection. Patching will not be permitted.

## SECTION 615

### 3.3 Installation of Traffic Signs.

**3.3.1** The top edges of all signs shall be horizontal. Any chipping or bending of sign panels shall be cause for replacement at the Contractor's expense.

**3.3.2** Ground-mounted signs in most cases should be erected to face 2 degrees away from the direction of approaching traffic. Ground mounted signs on curves or steep grades may need to be adjusted to maximize retroreflectivity. Overhead mounted signs shall be erected to face downward 5 degrees from vertical.

**3.3.3** The minimum sign height for a conventional road in a rural district shall be 6 feet. All other sign heights shall be in accordance with the MUTCD or [NHDOT Standard Plans](#).

**3.3.4** When two (2) or more signs are installed on the same supports, the signs shall be butted together unless otherwise specified on the plans or MUTCD. There shall be no gaps between the signs.

### 3.4 Overhead Traffic Sign Structures.

**3.4.1** Overhead sign structures shall be designed and installed in accordance with the AASHTO "Standard Specifications for Structural Supports for Highway Traffic Signs, Luminaires and Traffic Signals" including all interims except as modified herein. Refer to a Special Provision, Amendment to Section 615, for the design of cantilever and full-span overhead traffic sign structures with emphasis on the installation procedures for anchor rods.

Structures shall be designed to accommodate sign surface areas of 30 percent greater than those shown on the plans. Sign structures shall be designed based on the following criteria:

Basic Wind Speed: 100 mph

Design Life: 50 Years

Fatigue Importance Category: Category II (Category I for cantilever sign structures, span >30')

Natural Wind Gust Loading, Galloping loads (except for cantilevered four chord trusses), and Truck Induced Gust Loading shall be considered.

Vortex shedding effects do not need to be considered.

Overhead signs shall provide a vertical clearance of not less than 17 ft. – 6" over the entire width of the pavement and shoulders. Three (3) foot interior walkways, with OSHA approved railing, shall be provided for access to the back side of variable or dynamic message signs on overhead sign structures. For full overhead traffic sign structures the anchor bolt size and pattern shall be identical for both bases.

**3.4.1.1** The Contractor shall furnish the design calculations and complete shop drawings, or manufacturer's standard specifications and drawings, or both for the overhead structure proposed to be erected, including method of attaching signs to the structure for documentation in accordance with [105.02](#). The Contractor shall also supply, along with any pertinent design calculations, a list of the following forces and offsets:

Load Source:	Resultant Loading of Load Source:	Horizontal and Vertical Offset From Top of Foundation to Resultant Loading:
Truss or Cantilever Dead Load		
Sign(s) Dead Load		
Post(s) Dead Load		
Wind Load on the Horizontal Sign Support		
Wind Load on the Sign(s)		
Wind Load on the Post(s)		
Ice Load on the Horizontal Sign Support		
Ice Load on the Sign(s)		

Details of foundations for overhead structures will be furnished to the Contractor after submittal of the shop drawings.

**3.4.2** Triangular truss type overhead traffic sign structures shall not be permitted.

**3.4.3** Concrete shall be constructed in accordance with [Section 520](#). Reinforcing steel shall be constructed in accordance with [Section 544](#).

**3.4.4** Backfill shall be constructed in accordance with [Sections 209](#) or [508](#) as called for on the plans.

**3.4.5** Supporting columns shall not be mounted on the leveling nuts until the concrete has cured for at least 7 days or attained a minimum of at least 80 percent of its design compressive strength.

**3.4.6** When the sign panels are not to be installed immediately upon completion of the structure, an equivalent loading of the structure shall be provided.

**3.4.7** Sign mounting brackets shall be attached to the structure utilizing only bolted connections, which allow complete lateral and vertical adjustment of the sign over the roadway.

**3.4.8** The applicable provisions of 550.3 shall apply to sign structures.

**3.4.9** When overhead sign structures are ordered removed or relocated, the entire structure, mounting brackets, signs, and bases down to 1 foot below final ground level, shall be removed. Unless otherwise shown on the plans, the structure removed shall become the property of the Contractor.

**3.4.10** Sheeting and shoring, if required, shall conform to the applicable provisions of [Sections 503](#) and [506](#), as appropriate.

### **3.5 Traffic Signs Type A.**

**3.5.1** The posts for traffic sign mounts shall be set in the foundation holes and securely held in place by a brace or template before the concrete for the base is placed. All posts shall be plumb and properly oriented with the roadway. Flanges supporting a single sign will lie in the same plane.

**3.5.1.1** The forms and templates supporting the posts shall not be removed until the concrete has cured at least 24 hours. No sign shall be attached to the posts until the concrete has cured as provided in 3.4.5.

**3.5.2** After erection, all bare steel shall be thoroughly wire brushed or power-tool cleaned and covered with 2 coats of approved zinc-rich primer. The first coat shall be thoroughly dry before the second coat is applied.

**3.5.3** When rock is encountered in erecting posts, the depth to be drilled into the rock and any required grouting shall be as directed and subsidiary to the item.

**3.5.4** Sign panels shall be mounted horizontally on the posts as shown on the plans. The back of the panels shall be flush with the posts after the mounting is completed.

**3.5.5** When Type A signs are ordered removed, the entire assembly including the footings down to 1 ft. below ground level shall be removed. Unless otherwise shown on the plans, the steel and sign panels shall become the property of the Contractor.

**3.5.6** When Type A signs are ordered relocated, new steel posts and all necessary mounting hardware shall be provided unless otherwise shown on the plans. Unless otherwise shown on the plans, removed steel shall become the property of the Contractor.

**3.5.7** When Type AA bridge mounted signs are ordered to be removed, the bolt holes shall be filled and/or painted as directed. Unless otherwise shown on the plans, the steel and sign panels shall become the property of the Contractor.

**3.5.8** When Type AA signs are ordered to be relocated, all new mounting hardware shall be included to attach to existing structures on posts. Bridge mounted structures and overhead structures' vertical support braces shall be trimmed to match signs.

### **3.6 Traffic Signs Type B and C.**

**3.6.1** Aluminum posts shall be set in holes excavated to the proper depth. The anchors shall be constructed as shown on the plans. After inserting posts, the holes shall be backfilled with granular material placed in thoroughly compacted layers not exceeding 6" in depth, care being taken to preserve the alignment of the posts. When more than one post per sign is required, the posts shall be parallel and plumb. Posts bent or otherwise damaged shall be removed and replaced.

**3.6.2** Steel "U" posts may be set as specified in 3.6.1 or driven.

**3.6.2.1** When posts are driven, a suitable driving cap shall be used. Battered heads will not be accepted. Posts shall not be driven with the assembly or sign attached.

**3.6.3** When rock is encountered in erecting posts, the depth to be drilled into the rock and any required grouting shall be as directed and subsidiary to the item.

**3.6.4** When Type B or C signs are ordered removed, the sign and posts shall become the property of the Contractor, unless otherwise shown on the plans. Any existing concrete foundation shall be removed down to 1 ft. below final grade elevation.

**3.6.5** When Type B or C signs are ordered relocated, new posts and all necessary mounting hardware, including breakaway bases if required, shall be provided.

## SECTION 615

### Method of Measurement

4.1 Overhead traffic sign structures including bridge mounts will be measured as a unit. When more than one unit is specified in the Contract, separate item numbers will appear for each separate unit.

4.1.1 Removing overhead traffic sign structures will be measured as a unit, including the removal of the signs and sign bases as shown or ordered.

4.1.2 Relocating overhead traffic sign structures will be measured as a unit, including new anchor bolts and the removal of existing sign bases as shown or ordered.

4.2 Traffic sign Type A, B, C will not be measured, but shall be the square foot final pay quantities in accordance with 109.11 for traffic signs required as shown on the plans, including all necessary posts, footings, bases, and mounting hardware.

4.3 Traffic sign Type AA, BB or CC will not be measured, but shall be the square foot final pay quantities in accordance with 109.11 for traffic signs required as shown on the plans, including all necessary mounting hardware.

4.4 Removing traffic sign Type A or AA will be measured as a unit. A unit will include all footings to a minimum of 1 ft. below finished grade, posts, mounting hardware including bridge mounts, and all signs on the same post.

4.5 Removing traffic signs Type B, C, BB or CC shall be subsidiary unless otherwise noted. Removal will include all footings (to a minimum of one foot below finished grade, posts, mounting hardware and all signs on each post.

4.6 Relocating traffic sign Type A, B, C, AA, BB or CC will be measured as a unit. A unit will include removing footings and posts, furnishing new footings, posts and mounting hardware, trimming existing bridge mounted structures and overhead structural vertical support braces, and erection of all signs on the new post(s).

### Basis of Payment

5.1 Overhead traffic sign structures will be paid at the Contract lump sum price complete in place with the following stipulations:

5.1.1 Structure excavation for bases will be paid under Section 206.

5.1.2 Concrete required will be paid under Section 520.

5.1.3 Reinforcing steel required will be paid under Section 544.

5.1.4 Overhead traffic sign structures removed or relocated will be paid at the Contract lump sum price.

5.1.5 Sheeting and shoring for sign structures will be paid for under the appropriate items of Sections 503 and 506 as indicated on the plans. When not included as a bid item this work will be subsidiary to the structure item.

5.2 Traffic signs type A, B, C, AA, BB or CC are final pay quantity items and will be paid for at the Contract unit price per square foot complete in place in accordance with 109.11.

5.2.1 The accepted quantities of removing traffic sign Type A or AA or relocating traffic sign Type A, B, C, AA, BB or CC will be paid for at the Contract unit price per each unit.

### Pay items and units:

615.002	Breakaway Mounts	Unit
615.0071	Steel Sign Posts	Pound
615.0072	Steel Breakaway Sign Posts	Pound
615.0073	Aluminum Sign Posts	Pound

### KEY TO ITEM NUMBERS FOR SIGN STRUCTURES AND SIGNS

Item Number	Unit
615 .A B C DE	Item Number
615	Section Number
.A	Class of Structure
B	Sign Type
C	Treatment
DE	Identification or Location Number

A	Class of Structure	Unit
.0	Sign Post	Unit
.1	Full Traffic Sign Structure	Unit
.2	Cantilever Traffic Sign Structure	Unit
.3	Bridge Mounted Traffic Sign Structure	Unit
.4	Span Wire Traffic Sign Structure	Unit
B	Sign Type	
.01	Traffic Sign Type A	Square Foot
.02	Traffic Sign Type B	Square Foot
.03	Traffic Sign Type C	Square Foot
.04	Traffic Sign Type AA	Square Foot
.05	Traffic Sign Type BB	Square Foot
.06	Traffic Sign Type CC	Square Foot
C	Treatment	
--1	Open	
--2	Breakaway Mounts	Unit
--3	Removing	Unit
--4	Relocating	Unit
--5	On Existing Facilities	
--6	On New Facilities	
--8	Reset	
DE	Identification and Location	
---01		
---99		
615.01	Traffic Sign Type A (F)	Square Foot
615.012	Traffic Sign Type A, Breakaway Mounts (F)	Square Foot
615.013	Removing Traffic Sign Type A	Unit
615.014	Relocating Traffic Sign Type A	Unit
615.02	Traffic Sign Type B (F)	Square Foot
615.022	Traffic Sign Type B, Breakaway Mounts (F)	Square Foot
615.024	Relocating Traffic Sign Type B	Unit
615.03	Traffic Sign Type C (F)	Square Foot
615.032	Traffic Sign Type C, Breakaway Mounts (F)	Square Foot
615.034	Relocating Traffic Sign Type C	Unit
615.04	Traffic Sign Type AA (F)	Square Foot
615.043	Removing Traffic Sign Type AA	Unit
615.044	Relocating Traffic Sign Type AA	Unit
615.05	Traffic Sign Type BB (F)	Square Foot
615.054	Relocating Traffic Sign Type BB	Unit
615.06	Traffic Sign Type CC (F)	Square Foot
615.064	Relocating Traffic Sign Type CC	Unit
615.1000X	Full Traffic Sign Structure	Unit
615.2000X	Cantilever Traffic Sign Structure	Unit
615.3000X	Bridge Mounted Traffic Sign Structure	Unit
615.3030X	Removing Bridge Mounted Traffic Sign Structure	Unit
615.3080X	Reset Bridge Mounted Traffic Sign Structure	Unit
615.4000X	Span Wire Traffic Sign Structure	Unit
615.40301	Removing Span Wire Sign Structure	Unit
615.40401	Relocating Span Wire Sign Structure	Unit

**SECTION 616 -- TRAFFIC SIGNALS****Description**

- 1.1** This work shall consist of furnishing and installing traffic signals, pedestrian signals, or flashing beacons including poles, mast arms, foundations, backfill, and all necessary fittings, cables, and components as ordered.
- 1.2** Traffic signal terms shall be in accordance with those defined in the MUTCD.

**Materials**

**2.1** A list of the recommended materials required to install the system may be included as an amendment to this specification, but the Department will give no guarantee as to the completeness of this list.

**2.1.1** Electrical materials shall meet the standards herein, local and utility codes, and the National Electrical Code, where applicable.

**2.1.2** Drawings, manufacturer's specifications, and applicable catalog cuts for all materials and components shall be submitted in accordance with 105.02 within 21 days after award of the Contract. An additional set of final approved documents, to total 6 sets, shall be supplied to the Engineer.

**2.2 Traffic Signal Heads.**

**2.2.1 Housings.** Housings shall be constructed of die cast aluminum or polycarbonate with a smooth outer surface and shall be capable of holding the optical units securely in place. Housings shall be adaptable for pedestal, bracket, or rigid mast arm vertical or horizontal mounting. The assembled housing shall be dust proof and moisture proof. Each housing shall be equipped with a hinged door of die cast aluminum or polycarbonate to hold the lens and parts of the optical units. The doors shall be designed to ensure uniform pressure around the doorframe when closed. Doors shall be fastened by hinged wing nut assemblies or other approved fasteners. Unless otherwise indicated on the plans, lenses shall be furnished with approved tunnel visors (not less than 10"). If either longer visors than those specified above or louvers are deemed necessary, they shall be furnished and installed. All traffic signals shall be furnished with a 5" backplate. Backplates shall be louvered aluminum coated flat black, be fastened with stainless steel hex head slotted screws and a 3/16" by 3/4" stainless steel fender washer.

**2.2.1.1** The assembled housings shall be made up of individual sections fastened together with bolts. The assembly of sectional units shall present a smooth unbroken contour of pleasing appearance. Each end of the housing assembly shall have an opening for a 1-1/2" pipe nipple. The area around this opening shall be reinforced and serrated so that lock nuts will seat firmly.

**2.2.1.2** One cap shall be supplied with each assembled housing to act as a cover over the hole in the top to prevent water from entering.

**2.2.2 Housing adapters.** Housing adapters for pedestal mounting shall be constructed of cast iron. They shall be adjustable with serrated surfaces to permit the housing to be locked in the desired horizontal position. The adapters shall be secured to the bottom of the housing by means of a close nipple, shall slip fit at least 7" over a standard traffic signal post 4" in diameter, and shall be secured to the post by a minimum of four set screws. Adapters shall contain raceways from the housing to the post to protect the wires from the elements.

**2.2.3 Mast arm brackets.** Mast arm brackets shall be banded (not cabled) as indicated in the recommended list of materials shown in the proposal.

**2.2.4 Lamps.** LED lamps shall have a regulated power supply designed to electrically protect the diodes. The lamp shall be water tight and sealed to eliminate contaminants. The lamp shall be capable of operating at ambient air temperatures of -40° F to 140° F.

**2.2.4.1** Each LED module shall be wired with two leads which shall terminate at the terminal block in each signal head. Separate leads shall be used to wire the block to the base. Leads shall be 18 AWG stranded wire. All colors shall be bright and clearly defined and cover the insulation the entire length of the lead. The color of these leads shall be as follows:

- (a) From the receptacle behind the red lens: one red wire and one white wire with a red tracer;
- (b) From the receptacle behind the yellow lens: one yellow wire and one white wire with a yellow tracer;
- (c) From the receptacle behind the green lens: one green wire and one white wire with a green tracer;
- (d) From the receptacle behind the green arrow: one blue wire and one white wire with a blue tracer.

**2.2.5 Optics.** LED lamp life shall be a minimum of 100,000 hours of continuous operation. Power consumption for 12" indications including power supply shall not exceed 20 W and have an initial output of 1900- lumens.

**2.2.5.1** LED modules shall conform to the standards set forth by the Institute of Transportation Engineers and shall be of the color indicated, circular in shape, with a visible diameter of approximately 12".

### 2.3 Pedestrian Signal Heads.

**2.3.1 General.** Pedestrian signal heads shall be LED type conforming to the Institute of Transportation Engineers Standard for Adjustable Face Pedestrian Signal Heads. The LED aluminum pedestrian signal displays bright and uniform symbol message “HAND” in portland orange and “WALK PERSON” in lunar white. Both messages shall be contained in a single section head.

**2.3.2 Housings.** Housings shall be one piece die cast aluminum or polycarbonate complete with top, bottom, sides, and back. For mounting purposes, the top and bottom of the housing shall have openings to accommodate standard 1-1/2” pipe brackets. The outside surface of the openings shall be serrated to provide for positive positioning of the housing. Doors and fasteners shall be as specified in 2.2.1. The completed assembly shall be dust and moisture proof.

Each housing shall include a solar screen visor installed parallel to the face of the “HAND/WALKING PERSON” symbol. The solar screen assembly consists of a minimum of 20 straight horizontal louvers and 21 zigzag pattern louvers. The solar screen visor assembly shall be held in place using stainless steel screws.

**2.3.3 LED Modules.** Each LED module shall consist of an assembly that utilizes LEDs “RAISED HAND” and the “WALKING PERSON” modules as the light source in lieu of an incandescent lamp. Pedestrian LED modules shall be Engineered to fit in all ITE compliant conventional cast aluminum pedestrian signal housings. Each LED Module shall utilize appropriate technology to achieve the required color and shall be the ultra-bright type rated for 100,000 hours of continuous operation from -40° F to 165° F. Each individual LED module shall be wired such that a catastrophic loss or failure of one LED will result in the loss of not more than 5 percent of the signal module light output. The modules shall be rated for a minimum useful life of 48 months. All wiring and terminal blocks must meet the requirements of Section 13.02 of the ITE Publication Equipment And Material Standards, Chapter 2 (Vehicle Traffic Control Signal Heads).

**2.3.3.1** Each LED module shall feature two 39” long 20AWG minimum wire lead with strain relief and spade terminals for connection to the terminal block of the signal heads. One of the conductors shall contain white insulation to signify neutral. The color of other conductor shall be different and shall be used to differentiate between the “RAISED HAND” and the “WALKING PERSON” LED modules. The two conductors shall be 600 Volt, 20 AWG minimum, jacketed wires conforming to the National Electric Code, rated for service at 220° F. Each LED module shall incorporate a printed circuit board containing all required LEDs and circuit components.

**2.3.4 Lenses.** The external lens surface shall be smooth with no raised features, so as to minimize the collection of dirt, debris, and other particulate contaminants, which may impact luminous intensity, and to facilitate periodic cleaning. External lens facets are prohibited. Both the “RAISED HAND” and the “WALKING PERSON” LED modules shall be filled with LED’s to give the appearance that the entire image is illuminated when energized. Outlined images will not be permitted. The height of the “RAISED HAND” and the “WALKING PERSON” images on the module shall not be less than 10” and the width of each image shall not be less than 7” The uniformity ratio of an illuminated symbol shall not exceed 4 to 1 between the highest luminance area and the lowest luminance area in the module.

**2.3.5 Count Down Timers.** The countdown timer if required shall be 16” by 18” module, LED overlaid filled countdown style with the filled hand/man on the left and the countdown on the right. The module shall only operate in clearance cycle countdown mode. The module will start counting when the flashing clearance signal turns on and will countdown to “0” and turn off when the steady “Don’t Walk” signal turns on. The units shall not have any external attachments, dip switches, toggle switches or options that will allow the mode to be changed from counting the clearance cycle, to the full walk/don’t walk cycle or any other modification to the icons or digits. The control and regulation module shall be of the “smart” type in order for the countdown displays to be automatically adjusted with the programmed intervals of the traffic controller. At power on, the module enters a single automatic learning cycle. During the automatic learning cycle, the countdown display shall remain dark.

### 2.4 Traffic Signal Poles, Mast Arms, and Pedestals.

**2.4.1 General.** Traffic signal structures shall be designed in accordance with the AASHTO “Standard Specifications for Structural Supports for Highway Signs, Luminaires and Traffic Signals”. Traffic signal mast arms shall be designed to support all proposed components as shown on the plans. Minimum clearance to the bottom of overhead signal housings shall be 16 ft. Signal mast arm structures shall be designed based on the following criteria:

- Basic Wind Speed: 100 mph
- Design Life: 50 Years
- Fatigue Importance Category: Category II
- Natural Wind Gust Loading shall be considered
- Truck Induced Gust Loading, Galloping Loads and vortex shedding effects do not need to be considered.

**2.4.1.1** Steel structures, unless otherwise indicated, shall be hot dip galvanized in accordance with ASTM A 123.

**2.4.1.2** Concrete foundation shall be concrete Class B meeting the requirements of [Section 520](#). Reinforcing steel shall meet the requirements of [Section 544](#). The foundation shall be as shown on the plans.

## SECTION 616

**2.4.1.3** Anchor bolts shall conform to ASTM A 36/A 36M, Grade 55, having minimum yield strength of 55 ksi with threaded end and hex nuts (2 per bolt), galvanized in accordance with ASTM A 153.

**2.4.1.4** Mast-arm structure and foundation (when required) design calculations and shop drawings shall be submitted for documentation in accordance with 105.02.

**2.4.1.5** Wood poles shall be Class IV, with a fiber bending stress of 8,000 psi, to a length specified conforming to Rural Electrification Administration (REA) Specification DT-5C.

**2.4.1.6** Messenger cable and guy cable shall be seven strand wire with a breaking strength of 8,000 pounds, double galvanized in accordance with AASHTO M 111.

### 2.5 Traffic Signal Controllers and Cabinets.

**2.5.1 General.** The controller shall operate on 120 volt, 60 hertz (cycle) alternating current, and shall be delivered completely wired and enclosed in a weatherproof cabinet. All components shall be new, and unless noted, the use of solid state components shall be required. Controllers shall be programmable, menu driven, traffic actuated complying with NEMA Standard TS-1, with time base coordination module, overlaps internally generated by means of an overlap card as per NEMA Standard TS-1, with wire jumpers on a printed circuit board, internal Fire pre-emption module with “D” connector harness and capable of providing an exclusive pedestrian phase as part of a phase.

**2.5.1.1 Bench test.** All components of the controller and cabinet shall be bench tested for a minimum of 72 continuous hours by the Contractor at the Contractor’s facility prior to delivery to the project. A representative of the Bureau of Traffic shall verify the test check list. The Contractor shall notify the Engineer at least 3 days prior to testing as to the date, time and place that tests are to be performed. Testing shall be performed by a qualified Signal Technician using a testboard and in conformance with the design loads, phasings, timings and auxiliary equipment such as pre-emptions and pedestrian phases. Any defective component shall be replaced, retested and continuous testing continued. Test results shall be documented on a check list as provided by the Bureau of Traffic and these results attested by the signature of the performing technician. Upon completion of satisfactory bench testing, a written approval will be supplied to the Contractor by the Engineer for delivery to the project only. This approval does not relieve the Contractor from ensuring proper operation of the equipment. The approval shall accompany the cabinet and controller when delivered to the project.

**2.5.1.1.1** The checklist will contain the following items:

- A. Install all of the equipment into the cabinet as required per the plans and specifications.
- B. Set the phase timings of the controller in accordance with plans.
- C. Wire in load lamps, minimum rating of 90 watts, to the load packs in simulation to the intersection as per the plans.
- D. Check all of the wiring connections for physical tightness.
- E. Power up the cabinet.
- F. Observe the sequences, timings and operations of the controller in conformance to the plans and specifications.
- G. Using the phase test push buttons, insert a call for a phase and observe this phase as it is being called for sequencing, timing and returning to rest condition. Only one separate call for each phase shall be used.
- H. Using the pedestrian test push buttons, insert a call for each pedestrian phase and observe this phase as it is being called for sequencing, timing and returning to rest condition.
- I. Test the police panel switches, manual, on/off, flash/auto and test the police manual cord if present in the panel.
- J. When applicable test the pre-emption as follows:
  1. Fire Pre-emption
    - Optical Detector - With the receivers wired in the cabinet and using an emitter, test each fire run as per the plans.
    - Radio Detector - With the receiver wired in the cabinet and using an external radio transmitter, test each fire run as per the plans.
    - Hard Wired - Attach a temporary push button as per the plans and test each fire run as per the plans.
  2. Railroad Pre-emption
    - Simulate closing the calling circuit, either manually or electronically to call up the Railroad pre-emption, then check and verify that the sequencing, timings and intervals are as per the plans.
- K. Check exhaust fan controls by applying heat from a 100 watt lamp on an extension cord to the thermostat.
- L. Check heat lamp controls by cooling the thermostat.
- M. Check conflict monitor by testing for any conflicting Greens or Yellows by the use of a jumper wire attached to a displayed Green or Yellow and to the other non-parent Greens or Yellows to ascertain that conflicting colors are not present.

When all of the above procedures have been completed, the performing technician shall document the results on the approved form as provided by the Bureau.



**2.5.2 Controller cabinet.** Controller, timing and flashing mechanisms, circuitry, and other components shall be enclosed within a weather tight 1/8" thick aluminum "P" type cabinet with 2 shelves, side and back panels, a main door and a switch compartment door on a 12" aluminum extension base. All exterior seams shall be continuously welded.

**2.5.2.1** Two adjustable "C" mounting channels to allow for positioning of panels and shelves shall be installed on both side walls and back of the cabinet.

**2.5.2.2** The two adjustable equipment shelves shall span the entire width of the cabinet. No part of the back panel shall extend above the equipment shelves.

**2.5.2.3** The cabinet door shall be a minimum of 80% of the front surface area and shall be hinged on the right side with a continuous hinge. The cabinet doorframe shall be flanged on all four sides with a light/alarm switch bracket located in the upper right hand corner. The latching mechanism shall be a 3-point draw roller type made of steel with a center catch. The operating handle shall have provisions for padlocking in the closed position. The main lock shall be a Corbin 1548-1 and furnished with two number 2 keys. The door shall have a gasket that forms a weather tight seal between the door and the cabinet. The lower portion of the door shall be vented with louvers on the exterior to provide 100 cfm of air flow. A filter held firmly in place by side and bottom brackets shall cover the louver vents on the door's interior. A door restraint shall be furnished to prevent door movement during windy conditions.

**2.5.2.4** The exterior of the cabinet shall be natural aluminum. The interior surface of the cabinet and door, including shelves shall be painted with appliance white alkyd baked enamel paint.

**2.5.2.5** A switch compartment with removable back plate shall be furnished on the main door. The compartment door opening shall be flanged on all sides. The compartment door shall be hinged on the right side with a continuous hinge and have a gasket that forms a weather tight seal when closed. A compartment door lock Corbin RS57565 with key hole cover and two keys shall be furnished. The switch compartment shall contain:

- (a) Signal automatic/flash switch.
- (b) Signal on/off switch.
- (c) Signal automatic/manual switch.
- (d) A manual advanced police button.

**2.5.2.6** A ventilation fan powered by a 115 volt single phase motor and rated at an air flow of 100 cfm shall be installed at the top of the cabinet. The screened exhaust vent shall be vented between the top of the cabinet and the door. The ventilation fan shall be controlled by means of a thermostat with a range of 70 to 160 °F with overload protection and noise suppressor.

**2.5.2.7** A cabinet heat lamp of 100/150 watts shall be installed. The heat lamp shall be controlled by a thermostat located on the left side of the cabinet with a range from 0 to 50 °F.

**2.5.2.8** The cabinet power panel shall be installed on the right side of the cabinet 8" up from the mounting flange. It shall have a 30 amp and a 15 amp circuit breaker. The 15 amp breaker shall service the GFI duplex outlet, a switched light outlet, the heat lamp and the ventilation fan. The 30 amp breaker shall service all other items. The GFI outlet shall be mounted on the power panel. The switched light outlet shall be mounted on the upper right side. An AC line filter and ISTRAL series line filter for controller and conflict monitor and lightning/surge suppressor shall be installed on the power panel.

**2.5.2.9** Cabinet trouble light shall be a stainless steel, flex shaft type, 18" in length with on/off switch. Trouble light shall be mounted on the right-inside of the cabinet.

**2.5.2.10** The cabinet shall be furnished with a plastic print holder and 3 sets of cabinet prints showing all wiring. Print holder shall be mounted on the inside of the door.

**2.5.2.11** Cabinets shall be furnished with 10 self-tuning loop detector amplifiers. Loop detector amplifiers shall have as a minimum 4 operating frequencies, 15 levels of sensitivity, a sensitivity boost for small and high vehicles, internal loop diagnostics and LED fault indicators identifying and differentiating between an open or shorted loop, or a sudden 25 percent change in inductance and a RS232 serial port.

**2.5.2.12 Vehicle Detection Panel.** The vehicle detection panel shall be installed on the left side of the cabinet; the bottom edge shall be 10" from the mounting flange. Loop field terminals shall be protected from inductive transient surges by 150 V, 10 A Metal Oxide Varistor. All detector terminals shall be identified by number and shall correspond with the cabinet print. All detector harnesses shall be labeled as to phase and shall be a minimum of 6 ft. in length and neatly dressed.

## SECTION 616

**Detector panel for Type M cabinet shall be supplied with 6 harnesses wired as follows:**

- a. Detector harness 1 - Phase 1
- b. Detector harness 2 - Phase 2
- c. Detector harness 3 - Phase 2
- d. Detector harness 4 - Phase 3
- e. Detector harness 5 - Phase 3
- f. Detector harness 6 - Phase 4

**Detector panel for Type P cabinets shall be supplied with 10 harnesses wired as follows:**

- a. Detector harness 1 - Phase 1
- b. Detector harness 2 - Phase 2
- c. Detector harness 3 - Phase 2
- d. Detector harness 4 - Phase 3
- e. Detector harness 5 - Phase 4
- f. Detector harness 6 - Phase 5
- g. Detector harness 7 - Phase 6
- h. Detector harness 8 - Phase 6
- i. Detector harness 9 - Phase 7
- j. Detector harness 10 - Phase 8

**2.5.2.13 Load Switch.** The cabinet shall be supplied with 12 solid state cube type load switches with a 10 A rating meeting the requirements of NEMA TS-1. Load switches shall be provided with LED indicators on both input and output sides to indicate the state of the circuit on the load switch.

**2.5.2.13.1** The back panel shall have 12 load switch sockets completely wired including conflict monitor. All terminals shall be labeled for identification corresponding to the back panel print. Load switch sockets shall be wired as shown below.

<u>Load Switch Socket</u>	<u>Phase Assignment</u>
1	Phase 1
2	Phase 2
3	Phase 3
4	Phase 4
5	Phase 5
6	Phase 6
7	Phase 7
8	Phase 8
9	Pedestrian
10	Overlap A
11	Overlap B
12	Overlap C

**2.5.2.14 Flash Transfer Relays.** The cabinet shall be supplied with 6 flash transfer relays that meet the requirements NEMA Standard TS-1.

**2.5.2.14.1** The back panel shall have 6 flash transfer relay sockets completely wired and assigned as shown below:

<u>Relay</u>	<u>Assignment</u>
Flash Relay 1	Load Switch 1 and 2
Flash Relay 2	Load Switch 3 and 4
Flash Relay 3	Load Switch 5 and 6
Flash Relay 4	Load Switch 7 and 8
Flash Relay 5	Load Switch 9 and 10
Flash Relay 6	Load Switch 11 and 12

**2.5.2.15 Signal Flasher.** The cabinet shall be supplied with one (1) NEMA Type 2 solid state cube type signal flasher mounted on the back panel.

**2.5.2.16 Pedestrian/Vehicle Detector Test Panel.** A pedestrian/vehicle detector test panel shall be surface mounted on the interior side of the cabinet door. A push type test button shall be labeled and furnished for each phase. Pushing the button shall

cause a detector call to be placed on the controller for as long as the button is held. Test panel wires shall be enclosed in a cable harness.

**2.5.2.17 Controller On/Off Switch.** A controller on/off switch shall be surface mounted on the interior side of the cabinet door or in the upper right hand side of the cabinet.

**2.5.2.18 Conflict Monitor.** A 12-channel conflict monitor with liquid crystal display meeting current NEMA Standard TS-1 requirements shall be provided in the cabinet. The liquid crystal display shall have the capability of showing all 4 possible signals per channel. The monitor shall retain complete information on the last 9 events including which channels were active, the date and the time. The assignment of conflicting channels shall be by means of a standard NEMA program card. The monitor shall be wired to detect absence of voltage on all channels. The monitor shall have an RS232 serial port for down loading. Monitor channels shall be assigned as shown below:

Channel 1	Phase 1
Channel 2	Phase 2
Channel 3	Phase 3
Channel 4	Phase 4
Channel 5	Phase 5
Channel 6	Phase 6
Channel 7	Phase 7
Channel 8	Phase 8
Channel 9	Pedestrian
Channel 10	Overlap A
Channel 11	Overlap B
Channel 12	Overlap C

**2.5.2.18.1 Monitor Interlock Relay.** The cabinet shall be wired to detect the presence of the conflict monitor. Disconnection of the conflict monitor from its harness shall cause the intersection to go into flash.

**2.5.2.19 Fire Pre-emption.** Fire pre-emption shall be activated by optical detection equipment with optical detectors. Fire pre-emption shall clear the existing phase through a normal clearance followed by the fire phase as shown on the plans for the minimum time specified. The fire phase shall give a green in the called direction. The confirmation light and siren (if used) shall be activated only during the fire pre-emption phase, after the call phase is satisfied. Upon release of the fire pre-emption, the controller shall provide a green to the major movement.

**2.5.2.19.1** The Engineering, design, and integration of the fire pre-emption shall be by the manufacturer of the equipment, in cooperation with the supplier of the signal controller equipment.

**2.5.2.19.2** The confirmation light shall be operated by a solid state load switch cube surface mounted on a panel located on the left side of the cabinet. No back panel load switches shall be used for the confirmation light.

**2.5.2.19.3** Confirmation light shall be a self-contained 120 volt AC industrial strobe light beacon with a weather-resistant, fully enclosed, rugged, cast aluminum base and Lexan red optic lens.

**2.5.2.19.4** Optical detector locations shall be verified by the Engineer to assure optimum reception. Optical detector cable shall run unspliced from the optical detector head to the controller cabinet.

**2.5.3 Contacts.** All contacts used in connection with interval indications shall be of pure coin silver or equivalent, and shall be capable of breaking and carrying 10 A at 125 V alternating current. The contacts shall be readily accessible and capable of being replaced in the timer without the use of any tools other than pliers and screw driver.

**2.5.4 Flashers.** Intersection beacon flashers shall be housed in an approved cabinet containing: 25 A NEMA cube-type flasher, 10 A circuit breaker, and disconnect switch. All components shall be completely wired and mounted within the cabinet. Painting shall be in accordance with 3.12.

**2.5.5 Pedestals.** Meter pedestal shall be as indicated on the plans.

**2.5.6 Radio and television interference.** Electrical equipment shall be prevented from interfering with radio and television reception.

## SECTION 616

### 2.6 Cable and Wire.

**2.6.1 General.** Cable shall be plastic covered cable meeting the applicable requirements of the International Municipal Signal Association (IMSA) specifications. The conductor color coding shall not be by means of printed code. Actual color coding shall be used.

**2.6.2** The minimum size wire for the circuits shall be as follows:

Service	A.W.G.#
(a) To Controller	8 Stranded
(b) Controller to Pole or Pedestal	12 Stranded
(c) Pole or Pedestal to Receptacles	14 Stranded
(d) Controller to Push Buttons	14 Stranded
(e) Detector Loop Lead-In	16 IMSA Spec. 50-2
(f) Detector Loop Wire	14 IMSA Spec. 51-5
(g) Equipment Grounding Conductor	8 Stranded

**2.6.3** Detector loop lead-in cable shall be shielded, single pair, stranded conductors with a drain wire enclosed in polyethylene jacket conforming to the requirements of IMSA 50-2. The use of cables carrying more than one pair of conductors is prohibited.

**2.6.3.1** Each lead-in cable shall be marked with plastic tape corresponding to the following color code to identify which phase it pertains to at the splice(s) in both the pull box(es) and in the cabinet.

#### PHASE COLOR CODE

Phase 1	1 Blue
Phase 2	1 Green
Phase 3	1 Yellow
Phase 4	1 Red
Phase 5	2 Blue
Phase 6	2 Green
Phase 7	2 Yellow
Phase 8	2 Red

**2.7 Conduit.** Traffic signal conduit, pull boxes, frames, and covers shall conform to [614.2](#).

**2.7.1** Conduit for all lines, except the service, shall be 3" in diameter. Service conduit shall be rigid steel conduit 1-1/4" inside diameter.

**2.8 Painting.** Prior to erection and assembly, if not manufactured of polycarbonate material, the entire traffic or pedestrian signal housing and visors shall be painted with an approved zinc-rich primer and a finish enamel coat of federal yellow No. 13538. The door face and inside visor shall be federal black No. 17038.

**2.9** Backfill for foundations, unless otherwise ordered, shall be material conforming to the requirements of [209.2.1.2](#) - Granular Backfill-Gravel.

#### **Construction Requirements**

**3.1** All traffic signal and electrical installations shall comply with the requirements specified herein, local and utility codes, MUTCD, and the National Electrical Code (NEC).

**3.1.1** A preconstruction meeting with the Contractor, signal Subcontractor, Engineer and Bureau of Traffic representative shall be arranged not less than 3 days prior to the start of signal installation, to resolve any problems.

**3.1.2** The signal Subcontractor shall notify the NHDOT Bureau of Traffic, Signal Design Section no less than 3 days prior to final inspection of signal installation. This final inspection is required prior to signal activation.

**3.2** Each signal head mounted on a mast arm shall be installed with a 1/8" diameter aircraft. cable, looped around the mast arm and mast arm bracket, as a safety device to prevent the signal head from falling. Cable ends shall be fastened by two opposing "U" clamps. When suspended by this cable, the top of the signal head shall be no more than 6" below the bottom of the mast arm.

**3.3 Conduit lines.** All conduit lines necessary shall be constructed for the proper operation of the signals and shall conform to [614.3](#).

**3.3.1** All conduits terminating in the cabinet shall be sealed with duct sealant.

**3.4** Concrete foundations with anchor bolts to secure the traffic signal structures, flasher or controller cabinets, and meter pedestals, shall be installed at the locations specified. When directed, the concrete foundation for the controller cabinet shall be raised to any height up to 18" above the surface. Chamfer strips shall be used on all signal controller cabinet foundations. Forms shall be inspected before concrete is placed.

**3.4.1** Poles shall not be mounted on the leveling nuts until the concrete has cured for at least 7 days or attained a minimum of at least 80 percent of its design compressive strength.

**3.4.1.1** Provide protection for wiring from rodents and other elements as approved by the Engineer and/or as shown on the Plans.

**3.4.2** Prior to placing the controller cabinet on its foundation, silicone sealant shall be applied to the area of contact.

**3.4.3** The Contractor shall use bolt pattern templates when setting mast-arm anchor bolts, signal pedestal bolts and controller cabinet mounting bolts. The templates shall remain in place for a minimum of 24 hours.

**3.4.4** Wood poles shall have the butt end buried in the ground to a depth of 8 feet.

**3.4.5** Wood poles with back-guy cable shall have the butt end of pole buried 8 ft. into the ground. Poles shall be back-guyed using a 10-inch expanding anchor with 3/4" by 96-inch anchor rod. Thimble eyes of anchor rods shall extend 12" above ground. Cable used for back-guying shall be attached to the anchor rod by short bail automatic type grip and to the guy hook on the pole by a preformed type grip. Pole shall be drilled 14" from top and a 5/8" oval eyebolt installed with one square flat washer and square nut on the messenger side and one square washer, square nut and guy hook on the opposite side.

### **3.5 Inductive Loop Detectors.**

**3.5.1** Loop installation shall follow these specifications and the Loop Detail Sheet as to colors, connections, splicing kits, step procedures and materials used.

**3.5.1.1 Curb entry.** Nonmetallic conduit shall be utilized from the pull box to its intercept with the saw cut. The visible portion of the curbing shall not be cut for conduit installation. The chase from the saw cut to the splice box should extend no more than 1 ft. from the curb. Conduit shall be installed so that it directly receives the lead-in wire.

**3.5.1.2 Saw cut.** The saw cut shall be a clean, well-defined 5/16" wide cut and done without damaging the adjacent pavement. The saw cut depth shall be at least 1-3/4" for asphalt and 1-1/4" for concrete. The saw cuts shall be overlapped to provide full depth at all corners, and all slots requiring a right angle turn of wire shall be cut at a 45 degree diagonal angle. Prior to the installation of wire, the saw cuts shall be checked for the presence of ragged edges or protrusions, and cleaned and dried. Cutting dust, grit, oil, moisture, or other contaminants shall be removed.

**3.5.1.3 Loop wire installation.** All loop installations shall be made without damage to the wire or its insulation. All damaged wire shall be replaced. The loops shall be installed as per plans, and shall contain the required number of turns as shown or as recommended by the manufacturer.

**3.5.1.3.1** The wire shall be laid in the slot so that there are no kinks or curls and no straining or stretching of the insulation. Loop wire shall be installed as far down in the slot as possible, using a blunt object similar to a wooden paint stirrer, to seat the loop wire, but in no case shall a screwdriver or other sharp tool be used for this purpose. The loop lead-in wires shall be twisted to provide a minimum of one turn per foot from the loop to the pull box.

**3.5.1.3.2** A minimum of 3 ft. of slack shall be coiled and stored in the pull box. Where the loop wire crosses cracks or joints in the pavement, plastic sleeving shall be used to insulate the wire, to a minimum of 4" on either side of the crack or joint.

**3.5.1.4 Initial Testing.** Prior to pouring sealant, the detector loop and loop lead-in cable shall be checked for continuity, inductance, resistance and integrity of the insulation. The tests shall be made in the presence of the Engineer and results shall be recorded on the as-built plans in the space provided. If the results of the measurements fall outside the specified range for one or more tests, the Contractor shall replace any portion or all of the system until proper readings are obtained.

**3.5.1.4.1** The inductance of each detector loop lead-in cable system shall be measured at the controller cabinet with the drain wire connected to ground. The inductance of each detector loop lead-in in the system shall be between 175 to 500  $\mu$ H.

**3.5.1.4.2** The DC resistance of each detector loop lead-in cable shall be measured at the controller cabinet. The DC resistance shall be between 2 to 6  $\Omega$ .

**3.5.1.4.3** The resistance of each conductor to ground in the detector loop lead-in cable shall be measured by leaving the other conductor free and the drain wire connected to ground. This resistance shall be a minimum of 10 M $\Omega$  under any weather and moisture conditions.

## SECTION 616

**3.5.1.4.4** The resistance of the drain wire to ground in the detector loop lead-in cable shall be measured by leaving both conductors free and all other drain wires disconnected from ground. This resistance shall be a minimum of 10 MΩ under any weather and moisture conditions.

**3.5.1.4.5** The integrity of the insulation shall be checked by applying a meg-ohm meter between each end of the detector loop lead-in and the nearest reliable electrical ground. In the event that no available ground exists, a suitable ground shall be established for the measurement. The meg-ohm meter reading shall be a minimum of 10 MΩ under all conditions.

**3.5.1.5 Sealant.** Saw cut sealant shall be an approved flexible embedding sealant as included on the [Qualified Products List](#) maintained by the Bureau of Materials and Research used strictly in accordance with the manufacturer's instructions. The sealant shall be poured into the slot to half depth, checked for air bubbles or material pile up, and then filled to the roadway level. Excess sealant shall be removed by means of a squeegee, and in any case, neither a trough nor a mound shall be formed. Sufficient time shall be allowed for the sealant to harden in accordance with manufacturer's instructions before allowing traffic access to the area.

**3.5.1.6 Final testing.** Repeat the test procedure specified in 3.5.1.4.

**3.5.1.7 Detector feeder cable installation.** The feeder cable and the loop lead-in wire shall be terminated in the pull box and all connections shall be spliced, soldered, compounded and taped. The entire splice shall be encapsulated in a waterproof splice kit approved by the Engineer.

**3.5.1.8 Record keeping.** A record of any modifications to the original installation shall be made by the Contractor. The Contractor shall furnish the Engineer with 3 copies of the corrected or as-built plans including initial and final test results.

### 3.6 Service and Meter Box.

**3.6.1** When required, the Contractor shall furnish and install a service riser on the pole selected by the power company in conformity with the plans, and shall also furnish the power company its choice of equipment above the switch or breaker. Wire sizes shall be as specified by either the plans or the power company. In case of discrepancy, the larger size shall be used.

**3.6.2** A NEMA weatherproof disconnect switch and cabinet shall be furnished and installed at the location specified. The circuit breakers in this switch shall be 30 A.

**3.6.3** The Contractor shall make all arrangements for the service connection and be responsible for all charges incurred thereby.

**3.6.4** Under no conditions shall any equipment be installed on any utility pole unless specifically stated on the plans.

**3.6.5** The Contractor shall notify the telephone company whenever a service connection is to be made on a jointly owned pole, providing the telephone company with the following information:

- (a) Intersection
- (b) Pole Number
- (c) Date and time of preliminary arrangement with electric power company.

**3.6.6** In the case of underground services, the Contractor shall furnish and install all equipment as required by the power company, be responsible for all charges incurred thereby, and complete the work to the satisfaction of the power company. Meters shall not be installed in manholes.

**3.6.7** The initial power hook-up and operational costs will be paid by the Contractor during the Contract. Once the traffic signals are completed and accepted through the project final inspection process the monthly utility cost will be paid by the responsible party.

### 3.7 Signal Cable and Wire Installation.

**3.7.1** The Contractor shall furnish and install sufficient cable and wire to operate the system properly and at least 4 spare conductors in each cable run shall be provided.

**3.7.1.1** Each mast arm assembly shall have a dedicated cable run from the controller cabinet.

**3.7.2** No more than one cable shall be permitted in a conduit except to eliminate splices in pull boxes. When more than one cable is permitted, the area of combined cables shall not exceed 30 percent of the inside area of the conduit.

**3.7.3** All pedestrian signals and push buttons shall be individually wired from the field to the cabinet terminals.

**3.7.4** Messenger cable shall run unspliced between poles and shall be installed with a 5 percent sag in the wire when measured from the point of attachment to the middle of span. The cable shall be attached to the pole eyebolt by a preformed type grip on one end and an automatic type grip on the opposite end. Messenger cable shall be grounded to the back-guy cable.

**3.8** Signal bases, housings, and controllers shall be furnished and installed as required. All structures and housings shall be plumb after erection.

**3.8.1** Multiple housings on a single post shall be grouped together using 1-1/2" galvanized pipe and 1-1/2" galvanized rail fittings. All attachments to the posts shall be made by means of adapters conforming to 2.2.2. The center of all housings shall be in the same horizontal plane.

**3.9 Miscellaneous electrical equipment.** All additional electrical fittings, service conduit, switches, fuses, traffic signal bulbs, and such other hardware as is necessary to properly and securely install the equipment shall be furnished. All electrical fittings shall be weatherproof.

**3.10 Wiring and connections.** All connections shall be spliced, soldered, compounded, and taped, using the following color code:

(a) Red Wire	Red, Main Street
(b) Orange Wire	Yellow, Main Street
(c) Green Wire	Green, Main Street
(d) Red with tracer	Red, Side Street
(e) Orange with tracer	Yellow, Side Street
(f) Green with tracer	Green, Side Street
(g) White	Neutral for all signals
(h) Blue	All steady burning arrows
(i) Blue with tracer	Intermittent arrows
(j) Remaining	Push buttons and spares

Note: The white wire shall be used for all neutral connections and shall be connected to the service ground.

**3.10.1** No street lighting splices will be permitted in the mast-arm shaft. Splices for street lighting and lightning arrestors shall be located inside the nearest street light pull box.

**3.11 Ground connections.** All installations and equipment shall be bonded and grounded to the service ground rod in accordance with the requirements of the electric power company.

**3.11.1** Each signal cable run shall be installed with one green plastic covered copper ground wire to which all equipment shall be bonded in accordance with standard practice. Each base and post, cabinet, and any other component that would be considered a part of the signal system shall be bonded to the ground wire. This ground wire shall be connected to the ground rod at the controller cabinet.

**3.12 Painting.** All paint shall conform to Section 708. The following colors of enamel shall be used:

(a) Controller Cabinet	Outside: Natural Aluminum
(b) Housings	Yellow (3)
(c) Visors	Inside: Black (2); Outside: Yellow (3)
(d) Meter Box	Same color as its mounting.
	Federal No.
(1) Green Enamel	= H8-577
(2) Black Enamel	= 17038
(3) Federal Yellow Enamel	= 13538

After the signals have been completely installed, two coats of enamel shall be applied to all unpainted or scratched surfaces after the surface has been lightly sanded to remove gloss.

**3.13** Operating sequences shall be as shown on the plans or ordered.

**3.13.1** Operating sequences shall be verified by testing.

**3.13.2** In cooperation with the Fire Department, the Contractor shall make trial runs to ascertain proper timing of the fire pre-emption system. The minimum time shall be approved by the Chief of the Fire Department or the Chief's representative.

**3.14 Installation of signals and equipment.** The signals and equipment shall be installed by competent workmen or the manufacturer's representative.

**3.14.1** Prior to placing the signals in operation, the signal housing shall be hooded with approved non-transparent material or turned to clearly indicate that the signals are not in operation.

## SECTION 616

**3.14.1.1** Signs mounted on the signals not applicable to construction conditions shall be covered as specified in [619.3](#).

**3.14.2** All material including poles, foundations, fittings and cable shall be supplied and installed to make a complete operative installation.

**3.14.3** Signs installed on signal arms shall be mounted with “Astro Bracs” at a right angle to the roadway.

**3.15 Operation.** The Contractor shall commence the operation of the signal system only when permitted by the Engineer.

**3.15.1** The Contractor shall provide a qualified technician to thoroughly review and confirm that the system is satisfactory and operational as designed. Prior to the final inspection, the Contractor shall have a review with the NHDOT Bureau of Traffic representative and local officials (including Fire Department technician) to review and comment upon the system.

**3.16 Warranty.** Upon completion of the project, the Contractor shall forward to the Commissioner all warranties to the purchaser that the equipment which has been installed hereunder shall be free from defects in materials, workmanship, and title, and shall be of the kind and quality designated or described in the Contract. The foregoing warranty supersedes all other warranties whether written, oral, or implied. If it appears within 6 months from the date of Acceptance of the work that the equipment installed hereunder does not meet the warranties specified above, the Contractor shall promptly correct any defect or nonconformance with the specifications. This warranty does not relieve the Contractor of the requirement of [106.04](#).

### Method of Measurement

**4.1** Traffic signals and flashing beacons will be measured as a unit. Where more than one unit is specified in the Contract, separate item numbers will appear for each separate and complete unit.

### Basis of Payment

**5.1** The accepted quantity of traffic signals or flashing beacons will be paid for at the Contract lump sum price complete in place.

**5.2** When an item of conduit appears in the Contract, conduit for traffic signals will be paid for under [Section 614](#).

**5.2.1** When no item for conduit appears in the Contract, any conduit required will be subsidiary.

**5.3** Materials required under 3.9 shall be subsidiary.

### Pay items and units:

616.1__	Traffic Signals	Unit
616.15__	Traffic Signals – Fiber	Unit
616.2__	Flashing Beacons	Unit
616.4__	Relocating Traffic Signals	Unit
616.5__	Concrete Bases	Unit
616.6__	Relocating Flashing Beacons	Unit



**SECTION 618 -- UNIFORMED OFFICERS AND FLAGGERS****Description**

**1.1** This work shall consist of furnishing qualified uniformed officers, with or without vehicles, or flaggers as required to direct or control traffic through or around the work or as ordered.

**1.1.1** The Contractor may perform flagging operations with his own forces or through approved Subcontractors. Subcontractors shall comply fully with 108.01. Flaggers shall be the primary means for providing dynamic temporary traffic control operations in work zones.

**1.1.2** Uniformed officers shall have legal authority to enforce traffic laws on the roadways within the work zone. Uniformed officers may be utilized for their specific authority for operations beyond that of a flagger, such as assistance in speed control and traffic law enforcement, as necessary, and as approved by the Engineer.

**Equipment**

**2.1** Vehicles for use with uniformed officers shall be official police vehicles with appropriate police markings and blue flashing lights that are visible from 360° around the vehicle and to oncoming traffic. Given the variability of markings and light arrangements of police vehicles, the final determination of acceptable police vehicles shall be made by the Engineer. Police vehicles with roof mounted lights are preferable when available. Police vehicles used at night shall have dimmable blue flashing lights appropriate for nighttime operations.

**2.2** Traffic paddles and flagger equipment shall conform to those described in the MUTCD.

**2.3** Two-way radios for uniformed officers and flaggers shall be dependable, providing clear communication at all times between radio operators.

**2.4** For night operations, the use of lighting at flagger stations is required as stated in the MUTCD.

**Construction Requirements**

**3.1 Uniformed Officers.** Uniformed officers furnished by the Contractor shall have had formal training in the *Safe and Effective Use of Law Enforcement in Work Zones* course or approved equivalent.

**3.1.1** Effective April 1, 2013, all Uniformed Officers working on all NHDOT funded, including municipally managed, projects shall have successfully completed a NHDOT approved course on *The Safe and Effective Use of Law Enforcement Personnel in Work Zones*. This course shall be taken once every four years. Sources of NHDOT approved training can be found on the NHDOT website.

**3.1.2** Upon request by the Engineer, the officer shall provide verification of training within 48 hours.

**3.1.3** Uniformed officers shall be attired with regulation duty uniforms, headgear, high-visibility apparel in accordance with the MUTCD, and shall wear an exposed badge.

**3.2 Designated Flagger Trainers.** The Contractor or the Subcontractor(s) supplying flaggers shall have an employee(s) designated to train flag personnel. Designated trainers shall have taken a formal flagging course as described in 3.2.1 at least once every four years.

**3.2.1** A flagging course taken by employees designated to train shall consist of a minimum of 3 hours of training providing the following general information:

- A. Federal requirements as specified in the MUTCD.
- B. Need for consistent, current and understandable instruction from flaggers.
- C. Understanding of the MUTCD Part VI requirements.
- D. Awareness of types of motorists and vehicles (commuters, tourists, passenger, trucks, emergency, oversized, etc.).
- E. Safety of the work crew, motorists and the flagger.
- F. Qualities of a flagger.
- G. Flagger attire.
- H. Tools necessary to perform flagging operations and their correct use.
  - 1. Equipment which includes, but is not limited to, paddles, flags, flashlights for night, etc.
  - 2. Correct and appropriate hand signals.
- I. Work station safety including, but is not limited to, placement of advance warning signs, flagger station location, and flagger position.

## SECTION 618

- J. Additional requirements and differences of night flagging operations.
- K. Coordination with other flaggers, work crew, uniformed officers, and traffic signals.

**3.2.2** Designated trainers shall pass a written examination containing thirty or more questions reviewing the principles of flagging. A passing score shall be a minimum of 80 percent.

**3.2.2.1** Upon successful completion of the flagging course and passing the written examination, the attendee shall receive a flagger handbook and a designated trainer completion certificate. The completion certificate shall contain the name of the successful attendee, the name of the course provider, and the date of the course.

**3.3 Flaggers.** All flagging personnel shall be trained by a designated trainer at least once every four years. The course shall cover the topics outlined under 3.2.1. Each flagger shall receive from the designated trainer, a card or certificate that provides the date of training and the designated trainer's name. Upon request by the Engineer, the Contractor and its Subcontractors shall provide verification of training within 48 hours. Any flagger who is trained by a designated trainer and changes employer, must be retrained by the new employer. Flaggers may elect to take a designated trainer course to meet the training requirements in this section, which would not expire with a change of employers.

**3.3.1** Flaggers shall wear high visibility apparel in accordance with the MUTCD and their attire shall be distinctive from the other workers. Flaggers shall wear ANSI Performance Class 3 safety apparel when flagging during hours of darkness. While encouraged, the Class 3 requirement does not apply to pants.

### **3.4 Personnel Requirements and Authority.**

**3.4.1** Uniformed officers and flaggers shall work well alone and as a member of a group, since traffic control operations are a team effort. Therefore, uniformed officers and flaggers shall also possess strong communication skills, as relaying traffic information to others (uniformed officers, flaggers, construction personnel, the public, etc.) is essential. The Contractor shall be responsible for providing specific instructions to uniformed officers and flaggers regarding their duties and responsibilities, both to the public and to their fellow workers on the job. They shall have authority to direct the movement of construction vehicles as well as vehicles of the traveling public, and shall do all that is reasonable to expedite that movement.

**3.4.2** Uniformed officers shall have police powers granted by the authorities having legal jurisdiction in the work area.

**3.4.3** The Contractor shall designate a person as the responsible party to coordinate the traffic control procedures. This person shall be responsible to collect and report the time of actual traffic control to the Engineer.

**3.5** When more than one Uniformed Officer or Flagger is required for traffic control, effective communication shall be maintained between stations. If effective communication cannot be maintained by voice or hand signals, two-way radios shall be used. Necessary safety precautions shall be taken when two-way radios are used in the vicinity of blasting operations.

### **Method of Measurement**

**4.1** Uniformed officers, uniformed officers with vehicles, and flaggers will be measured by the actual numbers of hours authorized, as determined by the Engineer.

**4.1.1** The Contractor's schedule for utilizing uniformed officers, uniformed officers with vehicles, and flaggers shall be agreed upon cooperatively with the Engineer. The Contractor may furnish additional traffic control personnel at his expense but only those agreed upon by the Engineer will be measured for payment.

**4.1.2** In no case shall uniformed officers or flaggers be paid less than the flagger rate as specified in the Contract.

**4.1.3** Uniformed officers with vehicles provided by the Contractor in accordance with 3.6 will not be measured for payment.

### **Basis of Payment**

**5.1** The hours authorized for uniformed officers or uniformed officers with vehicles will be paid for at the invoice value plus a 5 percent mark-up.

**5.1.1** The invoice may include salary, fringe benefits and overtime for the rank of officer appropriate to perform the required duties, and a reasonable vehicle use charge for uniformed officers with vehicle.

**5.1.2** The Bidder's attention is called to the dollar amount inserted in the proposal under these items, which dollar amount is the amount the State has set for uniformed officers, or uniformed officers with vehicle. This amount must not be altered by the Bidder on the proposal, and must be included to obtain the grand total of the bid.

**5.1.3** Payment of the amount set in the proposal will not be on a lump sum basis, but only the dollar value as authorized will be paid.

**5.2** The hours authorized for flaggers will be paid for at the Contract unit price per hour.

**Pay items and units:**

618.6	Uniformed Officers	Dollar
618.61	Uniformed Officers with Vehicle	Dollar
618.7	Flaggers	Hour

**SECTION 619 -- MAINTENANCE OF TRAFFIC****Description**

**1.1** This work shall consist of providing and maintaining safe and passable traffic accommodations for public travel; preventing dust nuisance; and furnishing, erecting and maintaining necessary traffic signs, barricades, lights, signals, delineators, concrete barriers, pavement markings, and other traffic control warning devices and shall include pilot car operations and other means of guidance of traffic through the work zone. The Contractor shall be responsible for this work and shall perform it in accordance with the current MUTCD, Work Zone Traffic Control Standard Plans, the approved Traffic Control Plan (TCP) and these specifications.

**1.2** A list showing the permanent construction signs and warning devices will appear in the Contract plans. The Contractor shall determine the appropriate operational construction signs and warning devices based on the needs of the Contractors daily operation.

**Materials**

**2.1** Traffic control devices shall conform to the MUTCD and as specified herein. New devices covered by testing and evaluation criteria in the National Cooperative Highway Research Program (NCHRP) Report 350, titled “ Recommended Procedures for the Safety Performance Evaluation of Highway Features,” shall also conform to the criteria by the extended compliance dates implemented by the AASHTO-FHWA Agreement (350 Agreement) dated July 1, 1998. A summary of the work zone traffic control devices categories for new devices to conform with NCHRP Report 350 is provided in the Special Attention entitled “ Roadside Safety Hardware Worthiness Compliance with NCHRP Report 350 and MASH”.

**2.1.1** Base material for permanent construction signs shall be weather-proof, rigid substrate specifically manufactured for highway signing and meet the retroreflective sheeting application requirements of the sheeting manufacturer.

**2.1.2** Base material for operational construction signs shall conform to 2.1.1, except that flexible base material will be allowed.

**2.1.3** Retroreflective sheeting for traffic control devices, including permanent and operational construction signing, shall conform to AASHTO M 268 (ASTM D 4956), Type IV Retroreflecting Sheeting as a minimum or Type VI for flexible base material.

**2.1.3.1** Category I Traffic Control devices (plastic or rubber cones, tubular markers, flexible delineators, and plastic drums, etc.) shall have Type IV or higher sheeting.

**2.1.3.2** Orange signs mounted on fixed supports shall be a fluorescent orange color in accordance with [Section 718](#).

**2.1.3.3** Sign text shall consist of the letters, digits and symbols either applied by stick-on or silkscreen, to conform with the dimensions and designs indicated in the Contract, NHDOT Construction Sign Standards, MUTCD or FHWA Standard Highway Signs. The materials and methods shall be in accordance with standard commercial processes.

**2.1.3.4** Sign blanks shall be prepared in accordance with current practice as recommended by the sheeting manufacturer.

**2.1.4** Supports and posts shall conform to the current AASHTO “ Standard Specifications for Structural Supports for Highway Signs, Luminaires, and Traffic Signals”.

**2.1.5** Portable changeable message sign (PCM) shall be capable of up to three lines of display with eight characters per line. Characters shall be a minimum of 18” high.

**2.1.6** Trailer mounted speed limit signs shall be self-contained units, including sign assembly, flashing lights and power supply specifically constructed to operate as a trailer-mounted sign.

**2.1.6.1** Sign assembly shall be as shown in the NHDOT Construction Sign Standards.

**2.1.6.2** Each unit shall be equipped with two mono-directional flashing lights with amber lenses and reflectors which are visible through a range of 120 degrees when viewed facing the sign. The lights, LED, halogen or incandescent lamps, shall be visible for a minimum distance of one mile under daylight conditions and shall have a minimum flash rate of 40 flashes per minute. Bulb size shall be in accordance with the MUTCD. An “ ON” indicator light shall be mounted on the back of the signs which is visible for at least 500 ft. to provide confirmation that the flashing lights are operating.

**2.1.6.3** Power supply shall be either full battery power with solar panel charging (capable of maintaining a charged battery level) and 135 ampere, 12 volt deep cycle batteries, or diesel powered generator with a fuel capacity sufficient for 10 hours of continuous operation.

**2.1.7** The Contractor shall provide a Certificate of Compliance stating that traffic control devices being provided meet the testing and evaluation criteria of NCHRP Report 350 as implemented by the 350 Agreement.

**2.1.8** All category I, II, and III project work zone traffic control devices in use, except portable concrete barrier that transfers tension and moment from segment to segment, shall conform to the testing and evaluation criteria of NCHRP Report 350. Devices not conforming to the criteria shall be replaced with conforming devices at no expense to the Department.

**2.2** Calcium Chloride shall conform to AASHTO M 144, Type S, Grade 3.

### **Construction Requirements**

#### **3.1 Maintenance of Traffic.**

**3.1.1** Traffic control devices shall be properly placed and in operation before starting construction. When work of a progressive nature is involved, such as resurfacing, the appropriate traffic control devices shall be periodically repositioned in the advance warning area.

**3.1.2** Whenever the highway is open to public traffic through any part of the project, the Contractor shall provide and maintain sufficient surface for at least one lane of traffic, and two lanes whenever possible. Control of one lane traffic will be required at all times.

**3.1.2.1** The Contractor shall notify the Engineer at least two weeks prior to beginning work that involves any major disruption of traffic.

**3.1.3** Traffic Control devices, either existing or supplied by the Department, shall be maintained at appropriate locations for the use of the traveling public during the construction period. Signs which are not applicable to construction conditions shall be covered completely with plywood, removed or relocated as necessary. Signs that are removed or relocated shall be retained and re-erected by the Contractor. The Contractor shall notify the Bureau of Traffic when any regulatory sign is removed or relocated.

**3.1.3.1** All existing speed limit signs which conflict with the construction zone trailer mounted speed limit signs shall be covered completely as specified in 3.1.3 during the operation of the flashing lights. These signs shall be immediately uncovered when the use of the flashing lights is discontinued.

**3.1.3.2** Devices damaged due to improper handling and storage shall be replaced with new devices.

**3.1.4** Dust control shall be performed in an approved manner, generally by the use of water, and shall be continued whenever necessary, even if all other work on the project is suspended.

**3.1.4.1** The Engineer will determine when the use of Calcium Chloride is warranted to control dust nuisance. It shall be uniformly applied at a rate sufficient to control dust.

**3.1.5** The Contractor may be required to delay or suspend work, as directed, that interferes with traffic during commuting hours, periods of inclement weather, or periods of high traffic volumes which result in excessive backup or create unsafe traffic operations.

**3.1.6** For the protection of traffic, equip all vehicles used on the project with amber flashing lights or rotating lights visible from 360 degrees around the vehicle. The flashing light system shall be in continuous operation while the vehicle is on any part of the traveled lanes, shoulders or ramps within the construction zone.

#### **3.1.7 Blank.**

**3.1.8** Before any suspension of the work, including end of workday, the Contractor shall make passable and shall open to traffic such portions of the project and temporary roadways or portions thereof as may be agreed upon between the Contractor and the Engineer.

**3.1.8.1** Pavement authorized for removal for trenching purposes within the traveled way shall be replaced with temporary bituminous material (cold patch or reclaimed asphalt pavement) before the roadway is open to traffic and shall be replaced with applicable hot bituminous pavement conforming to Division 400 within 72 hours of completed backfill operations.

**3.1.9** When the work required as outlined in section 104.03 and 619.3.1.9.1 is completed by the Contractor, the Department will assume the winter maintenance of the roadway during the period of winter suspension without cost to the Contractor.

**3.1.9.1** The Contractor shall either remove or relocate all portable concrete barrier to a minimum offset of 6 feet (10 feet desirable) from the traveled way during the winter maintenance season. If the Department's traffic control plan and/or phase construction plan does not allow for this minimum offset and the snow built up in front of the barrier does not provide safe and passable accommodations to vehicular traffic, the snow accumulated in front of the portable concrete barrier shall be removed by the Contractor. The Contractor shall notify Highway Maintenance prior to performing this work.

**3.1.9.2** Prior to October 15 of each year that a Contract is in effect, the Contractor shall restripe the project between "Road Work 500 Feet" and "End Road Work" signs. This work will be paid under 632 items.

## SECTION 619

**3.1.10** When work is resumed after any suspension, the Contractor shall replace or renew any work or materials lost or damaged because of such temporary use of the project.

**3.1.11** If the Engineer determines that maintenance of traffic and provisions for safe traffic control are not being provided or maintained by the Contractor, the Department may assume this responsibility and deduct the cost from money due the Contractor.

**3.1.12** Any work performed by the Department, either when construction operations are taking place or during periods of suspension, will not invalidate the provisions of the Contract.

### 3.2 Traffic Control Devices.

**3.2.1** All traffic control devices supplied to the project shall be acceptable in accordance with the “Quality Standards for Work Zone Traffic Control Devices” as published by the American Traffic Safety Services Association (ATSSA) and the retroreflectivity shall be a minimum of 90 percent of new material.

**3.2.1.1** At any time during the life of the Contract, including any suspension, any traffic control device that is in an unacceptable condition as described in the “Quality Standards for Work Zone Traffic Control Devices” or has a retroreflectivity of less than 70 percent of new material shall be replaced.

**3.2.2** Construction signs shall be erected at the locations indicated on the plans or as approved. The posts shall be plumb. The signs shall be installed with the text horizontal.

**3.2.3** Traffic control devices shall be erected wherever necessary for the protection of public travel.

**3.2.3.1** Trailer mounted speed limit signs shall be used only during the Contractor's actual work hours, unless specifically authorized by the Engineer. Prior to the initial use of the speed limit signs, the Contractor shall submit, for approval, his schedule for use including the time of proposed speed limit reductions. This schedule shall be submitted two weeks in advance of the proposed initial use to allow the Engineer to contact the Bureau of Traffic, revise the proposed locations of the speed limit signs, if necessary, and authorize their use.

**3.2.3.1.1** The Engineer will record the actual time and location of the signs on a daily basis when the speed limit signs are in use.

**3.2.3.2** Trailer mounted speed limit signs shall be located, one on each shoulder, 2,000 feet in advance of the project limits for mainline traffic. A sign shall also be located on the right shoulder 1,500 feet beyond the end of ramp acceleration lanes within the project. Placement of additional “REMINDER” signs may be ordered by the Engineer.

**3.2.4** Operational signs and channelizing devices shall only be set up when weather conditions will allow adequate visibility.

**3.2.5** Lighting devices shall be provided as required or ordered. The type and number of lighting devices shall conform to the plans and the MUTCD.

**3.2.6** Keep all roadway areas that are open to traffic as clear as possible at all times. No materials or Contractor's plant and equipment shall be stored on any roadway areas or within the clear zone of the traveled way as specified in the TCP unless protected by portable barrier and specifically approved. Deliver materials to installation areas as needed to provide a continuous installation.

**3.2.6.1** Remove all equipment and construction vehicles from the traveled way and within the clear zone of the traveled way as specified in the TCP during non-work hours unless protected by portable barrier and specifically approved.

**3.2.6.2** Park workers' private vehicles close together in a group outside the clear zone of the traveled way as specified in the TCP unless protected by portable barrier and specifically approved.

**3.2.6.3** Traffic control devices, including arrow panels, portable changeable message signs and trailer mounted speed limit signs shall be removed outside the clear zone of the traveled way as specified in the Traffic Control Plan when not in use unless protected by portable barrier or equivalent and specifically approved.

**3.2.6.4** Trailer mounted traffic control devices, such as arrow panels, portable changeable message signs and trailer mounted speed limit signs shall be delineated with retroreflective temporary traffic control devices while in use. The trailers shall also be delineated by affixing a retroreflective material to them.

**3.2.7** Do not conduct any operation (including loading and unloading vehicles) on or near the traveled way without first setting up the proper lane closure and traffic control devices.

**3.2.8** All traffic control devices furnished by the Contractor shall remain the property of the Contractor unless otherwise specified and shall be removed at the completion of the project or when no longer required.

### 3.3 Pavement Marking.

**3.3.1** Pavement markings shall be used in combination with appropriate traffic control devices to clearly define the required vehicle paths in accordance with the MUTCD. The intended vehicle path shall be clearly defined by pavement markings or channelizing devices or both at the end of the work period.

**3.3.1.1** At the end of each day's paving operation on a traveled roadway, pavement markings for centerlines and lanelines shall be applied in accordance with the MUTCD and the Contract requirements. Temporary pavement markings may be used according to the NHDOT Work Zone Traffic Control Standard Plans and MUTCD, after which pavement markings that meet full MUTCD Standards shall be in place. All Temporary pavement markings shall remain in place while in service and if dislodged or rendered ineffective the temporary markings shall be replaced.

**3.3.1.2** Temporary raised pavement markings may be used according to the MUTCD or as amended by the Work Zone Traffic Control Standard Plans, in the same color as specified for the markings and installed according to manufacturer recommendations. Temporary raised pavement markers shall not be used to supplement or substitute for edge lines. Temporary raised pavement markers shall be a product listed on the [Qualified Products List](#) under the 619 items.

**3.3.1.3** Flexible raised pavement markers will not be permitted for use on Interstate or high speed, multi lane highways.

**3.3.2** The application of pavement markings and/or removal of existing markings may not be required during daytime construction operations when traffic is controlled by flaggers or uniformed officers and channelizing devices are in place.

**3.3.3** In the event that pavement markings are to be applied by the Department, the Contractor shall provide a clean surface and vehicle path free of obstructions.

**3.3.4** Pavement markings that are no longer applicable shall be obliterated immediately preceding or following the change in lane usage. Such change in lane usage shall not be implemented until sufficient time, equipment, materials, and personnel are available to completely obliterate the markings.

**3.3.5** Removable pavement marking tape shall be removed prior to placing subsequent pavement courses but not until immediately prior to beginning paving operations.

#### Method of Measurement

**4.1** Maintenance of traffic will be measured as a unit.

**4.2** Portable changeable message sign and trailer mounted speed limit sign will be measured as a unit. A unit shall consist of the sign as described, the trailer, fuel and all necessary moves as approved.

**4.2.1** Portable changeable message sign (unit/week) and trailer mounted speed sign will be measured as a unit week. A week shall consist of seven consecutive days beginning when the item is first used on the project. The number of units required each week will be specified in the Traffic Control Plan or as approved.

**4.3** The temporary bituminous material required in 3.1.8.1 will not be measured for payment.

#### Basis of Payment

**5.1** Maintenance of traffic will be paid for at the Contract lump sum price. Payment will be made periodically based on the anticipated construction period.

**5.1.1** When the project conditions warrant illumination and such work is not shown on the plans or in the Special Provisions, the cost of furnishing, installing, maintaining (including power) and dismantling the necessary lighting will be paid for as provided in [109.04](#).

**5.1.2** Replacements of any traffic control device required by 3.1.3 or 3.2.1 will be at the Contractor's expense.

**5.1.3** The material cost of calcium chloride will be paid for as provided in [109.04](#). The labor and equipment necessary for material application will be subsidiary.

**5.1.4** The material cost of permanent construction signs ordered but not included in the listing on the Contract plans will be paid for as provided in [109.04](#). The labor and equipment cost for installation will be paid for as provided in [109.04](#).

**5.1.5** When no provision for Maintenance of Traffic is included in the Contract, this work will be subsidiary.

**5.1.6** Unless otherwise provided for in the Contract, the material cost and placement of temporary bituminous pavement for trench patching will be paid as specified in [Section 403](#) under Item 403.99 Temporary Bituminous Pavement. When Item 403.99 is not included in the Contract, payment will be made at 1.5 times the cost of machine method specified under [Section 403](#).

**5.1.6.1** Temporary bituminous material required in 3.1.8.1 is subsidiary to [Section 619](#).

## SECTION 619

**5.1.7** Unless otherwise provided for in the Contract, the material cost and placement of permanent hot bituminous pavement for trench patching will be paid as specified in Section 403 under hand method. When hand method is not specified in the Contract, payment will be made at two times the cost of machine method specified under [Section 403](#). When no Contract items for pavement are specified, payment will be as provided in [109.04](#).

**5.1.8** Work ordered under 3.1.9.1 for snow removal related work will be paid for under Item 1008 Alterations and Additions as Needed – Winter Maintenance, when included in the Contract.

**5.1.9** All winter maintenance related work will be paid for under respective Contract items or be subsidiary to Section 619.

**5.2** Pavement markings, including temporary retroreflective paint pavement markings, will be paid for as provided in [632.5](#).

**5.2.1** Temporary raised pavement markings or temporary removable pavement marking tape required per 3.3.1.2, including maintenance, removal and disposal, will be subsidiary.

**5.3** Obliteration of pavement markings will be paid for as provided in [632.5](#).

**5.4** Work ordered under 3.1.10 that resulted from Department or Municipal maintenance operations will be paid for as provided in [109.04](#).

**5.5** Unless an item is included in the Contract for relocation or removing signs, only the relocation of Type A signs will be paid for as provided in [109.04](#). All other signs covered, removed or relocated as provided in 3.1.3 will be subsidiary.

**5.6** The accepted quantity of portable changeable message signs and trailer mounted speed limit signs will be paid for at the Contract unit price complete, for each unit used. Payment will be made periodically based on the anticipated need for each unit.

**5.6.1** The accepted quantity of portable changeable message sign (unit\week) and trailer mounted speed sign will be paid for at the Contract unit price complete. Payment will be made based on the use for each unit, whether used once or multiple times during a week.

### Pay items and units:

619.1	Maintenance of Traffic	Unit
619.25	Portable Changeable Message Sign	Unit
619.253	Portable Changeable Message Sign	Unit\Week
619.27	Trailer Mounted Speed Limit Sign	Unit
619.273	Trailer Mounted Speed Limit Sign	Unit\Week



**SECTION 621 -- DELINEATORS****Description**

**1.1** This work shall consist of furnishing and installing retroreflective delineators with or without posts as shown on the plans.

**Materials**

**2.1** Delineator posts shall be flanged channel section steel conforming to ASTM A 36 posts, galvanized in accordance with AASHTO M 111. The weight per foot shall be 1.12 lb. The post shall have 3/8" holes drilled or punched, before galvanizing, at 1" on center along the center line of the web, beginning 13/32" from the top and continuing 29" down the post. Post length shall be as shown in the [NHDOT Standard Plans](#) or as otherwise shown on the plans.

**2.1.1** All deliveries of delineator post shall be accompanied by a certificate of compliance, a certified mill test report, and a detailed bill of lading.

**2.2** Sheet material for delineators shall be sized to the dimensions and shapes shown on the plans and shall conform to one of the following:

- Aluminum sheeting conforming to ASTM B 209, Alloy 6061-T6 when 0.080" thick or ASTM B 209, Alloy 5052-H38 when 0.100" thick, or
- Steel conforming to ASTM A 635, galvanized in accordance with AASHTO M 111 (ASTM A 123) with a minimum thickness of 12 gauge, or
- For temporary conditions only, high-impact, ultra-violet resistant thermoplastic meeting the following minimum requirements:

<b>Property</b>	<b>Test method</b>	<b>Minimum Property Requirement</b>
Tensile Strength@ yield, psi	ASTM D 638	5,000
Impact Strength @ 73 °F, Ft. lb/in notch	ASTM D 256	10
Impact Strength @ -40 °F, Ft. lb/in notch	ASTM D 256	1.5
Flexural strength 1/4" @ 73 °F, psi	ASTM D 790	8,000
Flexural modulus 1/4" @ 73 °F	ASTM D 790	300,000

With a minimum thickness of 0.08"

**2.3** Retroreflective sheeting shall conform to AASHTO M 268 (ASTM D 4956) minimum of Type IV sheeting, silver, white, green, yellow, green or brown.

**2.4** Bolts for post mounting shall be aluminum alloy economy hexagon head machine bolts conforming to ASTM F 468 Alloy 6061-T6 supplied with nylon washers and vandal resistant nuts. Bolts for concrete barrier mounting shall be stainless steel hexagon head machine bolt conforming to ASTM A 276 Type 304 with an expansion anchor bolt embedded in the concrete as shown on the plans.

**Construction Requirements**

**3.1** Steel posts for delineators shall be installed at locations that are in accordance with the [NHDOT Standard Plans](#) or as otherwise shown on the plans. Posts may be set or driven and shall be plumb. Bent or damaged posts shall be replaced.

**3.1.1** When posts are set, holes shall be dug to the proper depth. Holes shall be backfilled with suitable material in layers not over 6" in depth and thoroughly compacted.

**3.1.2** When posts are driven, a suitable driving cap shall be used. After driving, the top of the posts shall have substantially the same cross sectional dimensions as the body of the post. Posts shall not be driven with the assembly attached.

**3.1.3** When rock is encountered in erecting posts, the depth to be drilled into the rock and any required grouting shall be determined by the Engineer.

**3.2** Each retroreflective delineator shall be securely bolted to posts, guardrail or barrier as required.

## SECTION 621

### Method of Measurement

4.1 Delineators will be measured by the number of delineators of the type specified.

4.1.1 Retroreflective delineator faces, of the type specified will be measured by the number of faces required.

### Basis of Payment

5.1 Delineators or retroreflective delineator faces will be paid for at the Contract unit price per each of the type specified, complete in place.

### Pay items and units:

621.1	Retroreflective Median Barrier Delineator	Each
621.2	Retroreflective Beam Guardrail Delineator	Each
621.31	Single Delineator with Post	Each
621.32	Double Delineator with Post	Each
621.33	Single Delineator Double Faced with Post	Each
621.34	Double Delineator Double Faced with Post	Each
621.4	Retroreflective Delineator Face	Each
621.5	Retroreflective Bridge Rail Delineator	Each

**SECTION 622 -- MARKERS AND BOUNDS****Description**

**1.1** This work shall consist of furnishing and erecting witness markers and bounds in accordance with and at the locations shown on the plans.

**Materials**

**2.1** Witness markers shall be studded "T" posts galvanized steel conforming to ASTM A 499. Galvanizing shall conform to AASHTO M 111 (ASTM A 123). The post shall be 1-3/8" wide, and 1-3/8" deep with a weight per foot of 1.33 lb. Post shall have a 5" high by 4" wide and 3/32" thick anchor plate riveted or swaged approximately 12" from the bottom. Posts shall be 7 ft. long.

**2.1.1** All deliveries of witness markers shall be accompanied by a certificate of compliance, a certified mill test report, and a detailed bill of lading.

**2.2** Concrete bounds shall be as shown on the plans with Concrete Class A conforming to [Section 520](#), and reinforcing steel conforming to [Section 544](#).

**2.3** Stone bounds shall be cut from hard and durable granite and shall be free from seams which would impair their structural integrity; solid quartz or feldspar veins will not be cause for rejection. Dimensions shall be 4 to 8" square by not less than 4 ft. in length. The top of the bound shall be roughly perpendicular to the length of the stone and shall have a 1/2" drill hole at least 1/2" deep near or at the center.

**2.4** Backfill shall conform to [209.2.1.2](#).

**Construction Requirements**

**3.1** Witness markers shall be set plumb and firm to mark ditch line drainage structures, ends of cross culverts, ends of slope drains and underdrains, or as ordered. Markers will not be used for pipes 36" and over.

**3.1.1** Witness markers shall be installed 30" in the ground.

**3.2 Concrete Bounds.**

**3.2.1** Bounds shall be set as ordered on the Right-of-Way lines, at the beginning and end of the project, at the beginning and end of curves, at the beginning and end of spirals, at angle points, and on tangents. The maximum distance between bounds shall be 1,000 ft.

**3.2.2** The exact location for each bound will be established from reference stakes set by the Engineer, and those reference stakes shall not be removed until the position of the bound has been checked by the Engineer.

**3.2.3** The excavation shall be made to sufficient depth to allow the bound to protrude above the natural ground surface 4" if in land to be mowed, 6" if in land not under cultivation, or 12" if in woodland. Bounds in the roadway slope shall be set to protrude not more than 6" on the low side. Bounds set in lawn areas shall be set flush with the existing ground. Bounds set in pavement areas shall be recessed approximately 1/2" from the pavement surface. The bound shall be set with the letters "NH" to read from the road, and the backfill shall be thoroughly tamped in place.

**3.2.4** Unless otherwise ordered, when rock is encountered, the bounds may be cut off as required and shall be firmly bonded to the rock as directed.

**3.2.5** When a tree or heavy root is encountered in setting a bound, a steel pin at least 12" long and 3/4" in diameter shall be driven when ordered. The bound shall then be set at the nearest practicable location as directed.

**3.3 Stone Bounds.**

**3.3.1** Stone bounds shall be set at points shown or ordered in accordance with 3.2 except that 3.2.1 and references to letters "NH" in 3.2.3 will not apply.

**3.4 Resetting.**

**3.4.1** Bounds to be reset shall be removed and reset without causing damage to the bounds.

**Method of Measurement**

**4.1** Witness markers, concrete bounds, and stone bounds of the type specified will be measured by the number of each installed or reset.

## SECTION 622

### Basis of Payment

**5.1** The accepted quantities of witness markers, concrete bounds, stone bounds, and bounds reset will be paid for at the Contract unit price per each for the kind specified complete in place.

**5.1.1** All excavation required for this work is subsidiary except for ordered excavation of solid rock for bounds will be paid as provided in [109.04](#).

**5.1.2** No extra allowance will be made for handling of bounds to be reset or for any excavation required to remove bounds from their original sites.

**5.1.3** Pins used as specified in 3.2.5 will be subsidiary.

#### Pay items and units:

622.1	Steel Witness Markers	Each
622.2	Concrete Bounds	Each
622.4	Stone Bounds	Each
622.51	Setting Bounds	Each
622.52	Resetting Bounds	Each

**SECTION 624**

***SECTION 624 -- RAILROAD PROTECTION***

**Description**

**1.1** This work shall include the installation and operation of gates, bell systems, warning lights, and other protective devices, all as required by the Railroad to protect the operation and assure the safety of its equipment.

**1.2** Refer to [104.07](#) and the Special Provision to Section 104.07 for additional railroad information and requirements.

**Method of Measurement**

**4.1** Railroad Protection – Devices and Installation will be measured as a unit and shall include all labor and materials needed to install and operate gates, bell systems, warning lights, and other protective devices.

**Basis of Payment**

**5.1** Railroad Protection – Devices and Installation will be paid for at the Contract lump sum price.

**Pay item and unit:**

624.2_	Railroad Protection – Devices and Installation	Unit
--------	--	------

## SECTION 625

### **SECTION 625 -- LIGHT POLE BASES**

#### **Description**

1.1 This item shall consist of concrete light pole bases constructed at the locations and of the design shown on the plans or as ordered.

#### **Materials**

- 2.1 Concrete shall be Class B conforming to [Section 520](#).
- 2.2 Granular backfill shall be gravel conforming to [209.2.1.2](#).

#### **Construction Requirements**

3.1 Light pole bases shall be either precast or cast in place.

3.1.1 When precast bases are used, the hole shall be dug wide enough to allow for proper placement and compaction of the required backfill. The bases shall be placed on a prepared surface which shall provide a firm foundation. Where rock or unstable soil is encountered, the material shall be excavated 6" below the bottom of the base, and granular backfill placed and compacted in place of the excavated material.

3.1.2 When bases are to be cast in place, the holes shall be dug wide enough to allow the placement of concrete of the required diameter. Except when solid rock is encountered, the excavation shall be made to the full depth required on the plans. When solid rock is encountered, the bottom of the hole shall be at least 3 ft. from the top of the base and the concrete shall be firmly bonded to the rock with approved anchor rods. Forms will be required for the top of the light pole base only to a minimum distance of 12" below the finished grade of the ground at the base. Sufficient excavation shall be made about that elevation to allow the proper placement of the forms and the proper placement and compaction of the required backfill.

3.2 After the precast bases have been set, or after the removal of the forms for cast-in-place bases, granular backfill shall be placed in the entire space outside the bases, to the level of the finished grade unless otherwise ordered. Backfill shall be made in layers not greater than 6", with each layer thoroughly compacted.

#### **Method of Measurement**

4.1 Light pole bases will be measured by the number of units installed.

4.1.1 When more than 3 ft. of conduit, measured horizontally, is required to be installed from the center of the base, the first 3 ft. will be subsidiary.

#### **Basis of Payment**

5.1 The accepted quantities of light pole bases of the type required will be paid for at the Contract unit price for each complete in place.

5.1.1 There will be no separate payment for excavation and granular backfill.

#### **Pay items and units:**

625.1	Concrete Light Pole Bases, Type A	Each
625.2	Concrete Light Pole Bases, Type B	Each
625.9	Concrete Light Pole Bases, Special Type	Each

**SECTION 628**

**SECTION 628 -- SAWED PAVEMENT**

**Description**

- 1.1 This work shall consist of sawing concrete pavement, bituminous pavement, or both, as shown on the plans or as ordered.
- 1.2 This work shall consist of sawcutting grooves, routing the grooves and sealing with joint sealant at the end of the concrete bridge deck at locations indicated on the plans or as ordered.

**Construction Requirements**

- 3.1 Concrete pavement or bituminous pavement to be sawed shall be accurately marked before sawing.
  - 3.1.1 Sawed bituminous pavement for bridge, points shall be marked on curbs at the end of the concrete bridge deck to aid in locating the end of the deck after pavement placement.
- 3.2 The equipment used to saw concrete or bituminous pavement shall be capable of sawing the pavement as shown on the plans or as ordered and shall produce a substantially vertical and sound face without deformation of the adjacent pavement. The use of methods other than sawing (i.e. cutting wheels, pavement breakers), which deform the pavement or leave an unsound face, will not be permitted.
- 3.3 Contraction joints to be cut in concrete pavement shall be cut to the width and depth as shown on the plans and filled with the type of filler shown on the plans.
  - 3.3.1 Grooves to be cut in bridge pavement shall be cut and routed to the width and depth as shown on the plans and filled with the type of filler shown on the plans.
- 3.4 Concrete pavement or bituminous pavement to be sawed in connection with laying pipes, roadway excavation, constructing curb, and the like shall be sawed to a sufficient depth to permit breaking the pavement at the cut.
  - 3.4.1 Where the pavement is found to consist of an overlay of bituminous pavement above a concrete slab, the cut shall be increased enough to score the underlying concrete so that the concrete can be broken in a reasonably uniform manner.

**Method of Measurement**

- 4.1 Sawed pavement of the type specified will be measured by the linear foot.
- 4.2 Sawed pavement for the purpose of installing culverts, storm drains, catch basins, drop inlets, manholes and conduit will not be measured for payment.

**Basis of Payment**

- 5.1 The accepted quantity of sawed pavement will be paid for at the Contract unit price per linear foot.
  - 5.1.1 No separate payment will be made for filler.
- 5.2 Sawed pavement for the purpose of installing culverts, storm drains, catch basins, drop inlets, manholes and conduit shall be subsidiary to their respective items.
- 5.3 Payment will be made under Item 628.3 only when bituminous concrete pavement and concrete pavement are sawed one above the other.

**Pay items and units:**

628.1	Sawed Concrete Pavement	Linear Foot
628.2	Sawed Bituminous Pavement	Linear Foot
628.22	Sawed Bituminous Pavement (Bridge)	Linear Foot
628.3	Sawed Pavement	Linear Foot

**SECTION 632 -- RETROREFLECTIVE PAVEMENT MARKINGS****Description**

**1.1** This work shall consist of furnishing, placing and removing white or yellow retroreflective paint pavement markings, preformed retroreflective tape pavement markings, retroreflective thermoplastic pavement markings at locations shown on the plans or as ordered.

**Materials****2.1 Traffic Paint.**

Traffic paint shall be prequalified for use. To prequalify a product, manufacturers shall supply a sample from each lot manufactured to the Bureau of Materials and Research for verification testing. Acceptable lots will be included on the Traffic Paint Batch List available at and maintained by the Bureau of Materials and Research. Final acceptance will be subject to testing of materials sample at the project. Each batch of paint delivered to the project shall be accompanied by a document issued by the supplier identifying the manufacturer, product, batch number and date of manufacture. Field sampling will be performed in accordance with NHDOT Test Procedure C1.

**2.2 Glass Beads.**

**2.2.1** Glass beads shall conform to AASHTO M 247 and shall be Type 1 with a moisture resistant coating.

**2.2.1** Glass beads shall not contain more than 200 parts per million arsenic or lead. A certificate of compliance, as required by 106.04, shall be provided to the Engineer upon delivery of the material to the project. The certificate of compliance from the manufacturer shall include the process, batch or lot number(s); corresponding date(s) of manufacturer; and a statement of the actual levels of arsenic and lead.

**2.3 Permanent Tape.**

**2.3.1** Preformed retroreflective pavement marking tape for extended service life shall conform to ASTM D 4505, Retroreflectivity Level I or II, Adhesive Class 2 or 3, Skid Resistance Level A or B. Level I tape should be used when no external lighting source (i.e. overhead lighting) is present and Level II markings should be used when an external lighting source is present. The tape shall be a product listed on the [Qualified Products List](#).

**2.4 Temporary Tape.**

**2.4.1** Retroreflective preformed pavement marking tape for limited service life shall conform to ASTM D 4592 Type I (Removable) or Type II (Non-removable). Type I tapes should be used in areas that require the tape to be removed in the future and Type II tapes should be used when the required service life of the tape is less than three months and can be left in place due to pavement overlay or other similar activity. Type I and II tapes shall have a minimum skid resistance of 45 BPN.

**2.4.1.1** Type I shall be a product listed on the [Qualified Products List](#). Type II Tape shall be approved by the Engineer

**2.4.2** Blackout pavement marking tape shall conform to ASTM D 4592 Type I (Removable), except that the material shall be matte black and not be retroreflective. The tape shall be a product listed on the [Qualified Products List](#).

**2.5 Preformed Thermoplastic.**

**2.5.1** Preformed thermoplastic material shall be composed of a resin resistant to degradation by motor fuels, lubricants etc. In conjunction with aggregates, pigments, binders, and glass beads which have been factory produced as a finished product. The thermoplastic material shall conform to AASHTO M249 with the exception of the relevant differences due to the material being supplied in a preformed state such as during time and flowability tests.

**2.5.2** Preformed thermoplastic material shall have factory applied surface beads in addition to the intermixed beads at a rate of 10 pounds per 100 square feet of markings. It also shall contain a minimum of thirty percent (30%) intermixed graded glass beads by weight.

**2.5.3** The surface, with properly applied and embedded surface beads, shall provide a minimum resistance value of 45 PN when tested according to ASTM E 303.

**2.5.4** The material shall be applied at a thickness of 80 mils.

**2.6 Extruded.**

**2.6.1** Thermoplastic material shall be homogeneously composed of pigment, filler, resins and glass beads. The pre-mix glass beads shall be uniformly distributed throughout the entire thickness of material. The material, when applied in accordance with the manufacturer's recommended procedures, shall be capable of resisting deformation by traffic. The material shall be tested in accordance with AASHTO T250 requirements.



**2.6.2** The binder shall be either alkyd or hydrocarbon conforming to AASHTO M249. If an alkyd thermoplastic is used, the binder shall consist of synthetic resins, at least one of which is solid at room temperature and high-boiling point plasticizers. At least 1/3 of the binder compositions shall be a maleic-modified glycerol ester resin and shall be at least 10% by weight of the total composition.

**2.6.3** Thermoplastic material shall not deteriorate by contact with sodium chloride, calcium chloride or other chemicals used to prevent roadway ice. The material shall also not deteriorate because of the oil content of pavement materials or from oil droppings or other effects of traffic.

**2.6.4** Material, when formed into pavement markings, shall be readily renewable by placing an overlay of the same material directly over the old markings. The new material shall bond itself to the old markings in such a manner that no splitting or separation takes place.

**2.7 Pavement Marking Recess.** Recessed pavement markings shall be installed as specified for permanent markings. The recess shall be uniform in depth across the entire width.

### **Construction Requirements**

#### **3.1 General.**

**3.1.1** All pavement markings of the type specified shall be applied at the locations shown on the plans or as ordered, and shall be in accordance with the MUTCD and the [NHDOT Standard Plans](#). Traffic control operations in conjunction with placing markings shall conform to 619 and the Traffic Control Plan.

**3.1.1.1** The Contractor shall establish the base line points at 50 ft. intervals on curves and 100 ft. intervals on tangent sections throughout the length of pavement to be marked under this section from the Department provided control points. All other pavement markings shall be applied according to the physical pavement layout provided. The Contractor shall provide the pavement marking layout on the final wearing course pavement to the Engineer at least 3 working days prior to installation of the permanent pavement markings unless otherwise permitted.

**3.1.1.2** Whenever existing pavement marking patterns are to be obscured and later restored, the Contractor shall take detailed measurements of all existing pavement markings to permit the Contractor to accurately prepare drawings to reproduce those patterns. Reproduced markings shall be placed in the correct location laterally to reflect the intended lane and shoulder widths as specified in the Contract or as directed. The Contractor shall also perform a good quality videotape survey showing all pavement markings in each direction of travel with appropriate audio description of location and direction. The drawings and videotape shall be submitted to the Engineer prior to obscuring any pavement markings on the project.

**3.1.1.3** The Contract Administrator shall be notified of the day and time of the pavement markings application a minimum of 48 hours prior to the application unless otherwise approved. This notification must be acknowledged. No payment will be made for materials placed without proper notification.

**3.1.1.4** In the event the Contractor cannot place pavement markings per [619.3.3](#) and [NHDOT Work Zone Traffic Control Standard Plans](#), the Bureau of Traffic shall be notified a minimum of 48 hours before the end of this period in order to apply applicable pavement markings. No item payment will be made and a callout charge of \$2,500.00 plus \$500.00 per mile of striping for this application will be deducted from money due the Contractor. In case of cancellation or the Contractor placing the pavement markings after notification, the callout charge will apply unless the Bureau of Traffic is notified by telephone at least 24 hours prior to the event.

**3.1.2** Longitudinal lines placed on tangent roadway segments shall be straight and true. Longitudinal lines placed on curves shall be continuous smoothly curved lines consistent with roadway alignment. All pavement markings placed shall meet the tolerance limits shown on the plans.

**3.1.3** Broken lines shall consist of 10 ft. line segments with 30 ft. gaps and shall meet the tolerance limits shown on the [NHDOT Standard Plans](#).

**3.1.4** ReflectORIZED paint and thermoplastic pavement markings shall be applied in one pass at the width specified; preformed retroreflective pavement marking tape and thermoplastic shall be applied at the full width specified. Unless otherwise specified, widths of pavement marking lines shall be as follows:

## SECTION 632

Line Type	Width - inch	
	Interstate* Applications	All Other Applications
Centerlines	N/A	4
Edgelines	6	4
Lane Lines	6	4
Gore Markings	12	8
Crosswalk Lines	N/A	6
Parking Space Markings	N/A	4
**Stop Lines	N/A	18

\* Interstate criteria may be used on other divided highway facilities where shown on the plans or ordered.

\*\* Stop Lines can be applied in three passes if necessary

**3.1.5** Newly applied pavement markings shall be protected from traffic until the material has cured. The method of protection shall not constitute a hazard to the traveling public. As a minimum, when striping two-way roadways, an escort vehicle shall precede and another shall follow the pavement marking truck. On one-way divided roadways, at least two escort vehicles shall follow the truck to protect pavement markings from traffic. Additional escort vehicles may be required on multi-lane roadways. Damage to any markings as a result of tracking shall be repaired by the Contractor at no cost to the Department.

**3.1.6** The use of pavement markings other than in their final location on wearing course will only be permitted if the marking material is designed to be removed without the use of heat, solvent, grinding or blast treatment, and leaves no visible scar on the surface.

**3.1.7** The Contractor shall furnish and have available for the Engineer's use a pavement temperature gauge.

**3.1.8** All clean up and disposal of solvents, residue, and the like shall be the responsibility of the Contractor and shall be performed in accordance with all applicable federal, state and local regulations.

### 3.2 Retroreflective Pavement Marking Paint.

**3.2.1** All equipment used for highway striping shall be specifically designed and manufactured for that purpose by a company experienced in the design and manufacture of such equipment and approved for use. Equipment used for longitudinal lines shall be mounted on a truck having a minimum gross vehicle weight rating of 14,000 lb. with a minimum paint tank capacity of 60 gal, and shall have the capability of placing double lines up to 4" in width or single lines up to 12" in width in one pass. Each paint tank shall be plainly marked in a prominent place with the maximum filled capacity of the tank. Each tank shall have a mixer or aerator capable of combining and maintaining the ingredients of the paint into a thoroughly mixed and uniform mass. The paint shall be applied with an atomizing or airless spray type striping machine having the waterbase paint at a temperature of 105 °F maximum in the heat exchanger and 85 – 105 °F at the spray nozzle. Paint shall pass through a screen with a maximum opening of 1/8 " located before the heat exchanger. A valve accessible for sampling shall be located in the paint feed line between the screen and the heat exchanger. The striping machine shall be equipped with an automatic paint stripe controller having skip-line capability to place broken lines in accordance with 3.1.3 and the [NHDOT Standard Plans](#). A gauge reading paint temperature shall be mounted and conveniently displayed on the equipment. The equipment shall include a mechanical, glass-bead dispenser mounted not more than 12" behind the paint dispenser. All equipment shall be kept in good operating condition.

**3.2.1.1** Vehicles and equipment will be subject to inspection by the Bureau of Traffic at their office located in Concord at least once per year prior to the first application of material and as frequently as considered necessary thereafter. Yearly inspection shall be arranged with a ten working day notification. Approved vehicles will receive a seal for that year. If found unfit to function properly, the vehicle will be disapproved for use until correct operating conditions have been obtained.

**3.2.2** Immediately before applying the pavement marking paint to the pavement, the Contractor shall ensure the surface is dry and entirely free from dirt, sand, grease, oil, or other matter which would prevent effective adhesion of the paint to the pavement.

**3.2.3** The surface temperature of the pavement shall be a minimum of 40 °F.

#### 3.2.3.1 Cold Weather Paint.

When paint must be applied between the dates of October 15 through April 15 inclusive or on pavement with a surface temperature below 40 °F, cold weather paint can be used which does not exceed EPA's Federal Register/Rules and Regulations

(40 CFR Part 59 [AD-FRL-6149-7] RIN 2060-AE55), as amended, for VOC content limit and shall meet the AASHTO M248 F and requirements noted below. These products shall be applied according to the manufacturer's requirements.

**3.2.3.1.1** The Contractor shall provide a copy of their cold weather paint specification and a sample of each batch to the Bureau of Materials & Research per 708.03 – Approval, Sampling and Testing for approval. Each batch sample shall include lab test results verifying that the paint meets their specification. Refer to the Traffic Paint Batch list for approved cold weather paints. The cold weather paint shall meet the following minimum requirements.

Property	Test Method	Requirement
Dry Opacity (contrast ratio)	ASTM D2244 – with a wet film thickness of 15 mil	0.96 Min.
VOC	ASTM D3960	1.25 lb/gal Max.
Drying time	ASTM D7111 with wet film thickness of 15 mils	15 Minutes max @ 77 °F

**3.2.3.1.2** The thickness of the paint and the bead application shall be at the manufacturers recommendation. This information shall be stated in their specification submittal with batch sample and also provided to the Engineer.

**3.2.4** Paint shall be applied to a thickness of 20 mil wet.

**3.2.5** Glass beads shall be evenly applied through the entire paint thickness at a rate of 8 pounds to each gallon of water base or alkyd paint. Glass beads shall be applied simultaneously with paint, by pressurized or mechanical drop methods.

**3.2.6** All clean up and disposal of solvents, residue, and the like shall be the responsibility of the Contractor and shall be performed in accordance with all applicable federal, state, and local regulations.

**3.2.7** The Contractor shall furnish and have available for the Engineer's use the following inspection equipment:

Wet Film Thickness Gauge:	Scales which range from 2 to 30 mils in 2 mil increments.
Pocket Microscope:	Scope having a four-part lens system with magnification of 20x and a clip-on accessory light.
Striping Calibration Kit:	Volumetric bead calibration kit shall be complete with instructions, as manufactured by Potters Industries, Inc., or approved equal.

**3.2.7.1** Contractor shall measure all paint tanks (white & yellow) with paint stick prior to painting and after to determine the number of gallons used. Contractor shall also provide the Engineer their footage at the end of striping by zeroing out or recording the footage on their footage meters prior to and at the end of striping. All footage meters shall be able to measure white & yellow separately.

**3.2.8** Painted lane lines, edgelines, and centerlines shall have a minimum retroreflectivity of 200 millicandelas for white and 150 millicandelas for yellow. The retroreflectivity measurement will be taken by the Department on lines that are clean and dry within 30 days of application, before any winter maintenance takes place.

Retroreflectivity measurements will be taken by the Department for acceptance in accordance with ASTM E 1710. All readings shall be taken with the test instrument centered on the line.

A minimum of two groups of 10 retroreflectivity tests will be performed within a 200 ft. length for the first 2 miles of each line length or less per project. An additional 10 retroreflectivity tests will be performed for each additional 2 mile line length or less. The location of these test groups will be at the selection of the Department. No more than 10% of all tests taken for each line shall be below the minimum retroreflectivity (see chart below). When this requirement is not met, the entire line will be restriped at no additional expense to the Department. The Contractor shall provide traffic control and line cleaning for testing, as requested by the Engineer. Traffic control and line cleaning, will be subsidiary to Item 619 and Item 632 respectively.

Project Mileage	# Retro Tests Required	# Retro Tests to Fail Failure >10%
0-2 miles	20	3
2-4 miles	30	4
4-6 miles	40	5
6-8 miles	50	6
8-10 miles	60	7
10-12 miles	70	8

## SECTION 632

**3.2.9** All painted pavement markings including cold weather paint shall receive a second application within seven (7) to ten (10) days after the first application if it is anticipated that the markings will be in place for the winter maintenance season. Retroreflectivity requirements stated in 632.3.2.8 shall be met for each painting application.

### **3.3 Preformed Retroreflective Pavement Marking Tape.**

**3.3.1** Preformed pavement marking tape shall be applied at locations shown on the plans by mechanical or manual methods. Mechanical applications shall be suitable for all markings. Manual applications shall normally be used for transverse lines, symbols and legends. The manufacturer shall provide technical assistance for equipment operation and maintenance, and product applications.

**3.3.2** Preformed pavement marking tape shall be stored and applied as directed by the manufacturer. All markings applied after September 1 of any year shall be applied using the inlay method, unless specifically permitted by the Engineer. Prior to September 1, application by either the inlay or overlay method will be permitted, unless otherwise specified. When the inlay method is used, paving and marking operations shall be coordinated to meet the manufacturer's recommendations.

**3.3.2.1** For the inlay method, the pavement markings shall be embedded in the pavement surface with a conventional steel wheel roller. The surface temperature of the pavement shall be within the range specified by the manufacturer and shall not deform or discolor the markings.

**3.3.2.2** When applying pavement markings by the overlay method, the pavement surface shall be clean, dry and above the minimum temperature as specified by the manufacturer. The surface shall be broomed clean and all dust shall be removed using compressed air. When required by the manufacturer, a coat of primer/adhesive activator shall be applied.

**3.3.3** The Contractor shall provide a copy of the manufacturer's storage and application recommendations and the manufacturer's certificate of compliance to the Engineer upon delivery of the material to the project. The certificate shall include the process, batch, or lot number(s) and corresponding date(s) of manufacture.

**3.3.4** The required quantity of preformed pavement marking tape shall be available at the project prior to the start of applicable paving operations.

**3.3.4.1** Material shall be delivered to the project in original containers. Each container shall be clearly marked to indicate the color of the material, a specific description of the contents, and the process batch or lot numbers.

**3.3.4.2** Material found to be discolored or damaged in any way or material manufactured more than one year prior to installation shall not be used.

### **3.4 Retroreflective Thermoplastic Pavement Marking.**

**3.4.1** Thermoplastic pavement markings shall be applied to the road surface in a molten state by screed/extrusion method with a surface application of glass beads.

**3.4.1.1** All equipment used to apply thermoplastic pavement markings shall be constructed to provide continuous uniform heating at temperatures exceeding 400 °F during mixing and agitation of the material. Equipment used for longitudinal lines shall be mounted on a truck having a minimum gross vehicle weight of 14,000 lb, and shall have the capability of placing double lines up to 4" in width or single lines up to 12" in width in one pass. The equipment shall operate so that all mixing and conveying parts, including the line dispensing device, maintains the material at the required plastic temperature. The use of pans, aprons or similar appliances which the dispenser overruns will not be permitted. The striping machine shall be equipped with an automatic stripe controller having skip-line capability to place broken lines in accordance with 3.1.3 and the [NHDOT Standard Plans](#), and a glass bead dispenser located immediately behind the material dispenser. All equipment shall be kept in good operating condition.

**3.4.1.2** A special kettle shall be provided for uniformly melting and heating the thermoplastic material. The kettle shall be equipped with an automatic thermostat control device and material thermometer for positive temperature control and to prevent overheating or under heating of the material. The heating kettle and application equipment shall meet the requirements of the National Fire Underwriters, the National Fire Protection Association and state and local authorities.

**3.4.2** Immediately before applying the thermoplastic to the pavement, the Contractor shall ensure the surface is dry and entirely free from dirt, sand, grease, oil, or other matter which would prevent effective adhesion of the thermoplastic material to the pavement.

**3.4.2.1** When recommended by the manufacturer of the thermoplastic material, a primer/sealer shall be applied to the pavement surface prior to the application of the thermoplastic material. The primer shall be void of solvent and water prior to the thermoplastic application.

**3.4.3** Thermoplastic pavement marking materials shall not be applied when air and/or pavement surface temperatures are below 50 °F, or when the surface of the pavement contains any evidence of moisture.

**3.4.4** Thermoplastic material shall be applied to the pavement at a thickness of 125 mils.

**3.4.5** Glass beads shall be evenly applied to the surface of the completed marking at a rate of 10 pounds per 100 square feet of markings. Glass beads shall be applied by pressurized or mechanical drop methods.

**3.4.6 Preformed Thermoplastic.** Preformed thermoplastic pavement markings shall be a resilient white thermoplastic product with uniformly distributed glass beads throughout the entire cross sectional area. The markings shall be resistant to the detrimental effects of motor fuels, lubricants, hydraulic fluids etc. The markings can be used for stop lines, legends, symbols, and crosswalks, and shall be capable of being affixed to bituminous concrete pavements by the use of the normal heat of a propane torch.

**3.4.6.1** The markings shall be capable of conforming to pavement contours, breaks and faults through the action of traffic at normal pavement temperatures. The markings shall have resealing characteristics, such that they are capable of fusing with themselves and previously applied thermoplastic when heated with the torch.

**3.4.6.2** The marking must be able to be applied on pavement with a surface temperature down to 40 °F without any preheating of the pavement to a specific temperature.

### **3.5 Obliteration of Pavement Markings.**

**3.5.1** Pavement marking obliteration shall result in a minimum of pavement scar and shall obliterate all evidence of the existing pavement marking material. Removal may be performed by grinding, sand or water blasting, blackout tape, or other method(s) approved by the Engineer that do not materially damage the pavement surface.

**3.5.2** “Painting” over pavement markings with paint, asphalt mixtures or any other material is prohibited.

**3.5.3** Removal and disposal of pavement markings including, but not limited to retroreflectorized paint, retroreflective thermoplastic, preformed retroreflective tape and raised pavement markers shall be the responsibility of the Contractor in accordance with all applicable federal, state, and local regulations.

### **Method of Measurement**

**4.1** Retroreflective pavement marking lines of the type and width specified including the second paint application stated in 632.3.2.9 will be measured by the linear foot, to the nearest foot of length of marking applied.

**4.1.1** Double lines and combination solid/broken lines will be measured as separate lines according to the length of each individual marking applied.

**4.2** Retroreflective pavement marking symbols or words of the type specified will be measured by the square foot, to the nearest 0.1 of a square foot of area applied, based on established areas as shown on the Standard Sheets (Plans).

**4.3** Repair work ordered under 3.1.5 will not be measured.

**4.4** Raised pavement markers will be measured by each for each marker installed.

**4.5** Obliterate pavement marking lines of the type specified will be measured by the linear foot, to the nearest foot of length of marking, with no adjustment for width.

**4.6** Obliterate pavement marking symbols or words of the type specified will be measured by the square foot, to the nearest 0.1 of a square foot, based on established areas as shown on the Standard Sheets (Plans).

**4.7** Work ordered under 3.1.1.4 will be measured to the nearest tenth (0.1) of a mile

### **Basis of Payment**

**5.1** The accepted quantities of retroreflective pavement marking lines of the type and width specified will be paid for at the Contract unit price per linear foot complete in place.

**5.1.1** If preformed retroreflective tape, removable is ordered, and not included in the Contract, it will be paid as provided for in 109.04.

**5.2** The accepted quantities of retroreflective pavement marking symbol or words of the type specified will be paid at the Contract unit price per square foot complete in place.

**5.3** Additional equipment or labor necessary to apply preformed retroreflective pavement marking tape by the inlay method will be subsidiary.

**SECTION 632**

**5.4** The accepted quantities of obliterate pavement marking lines will be paid for at the Contract unit price per linear foot. Payment will not be made for the removal of removable pavement marking tape.

**5.5** The accepted quantities of obliterate pavement marking symbols or words of the type specified will be paid for at the Contract unit price per square foot. Payment will not be made for the removal of removable pavement marking tape.

**KEY TO ITEM NUMBERS FOR PAVEMENT MARKINGS**

Item Number		Unit
632	.A B C D	Item number
632		Section number
	.A	Material
	B	Type of marking
	C D	Width of line
	.A Material:	
	0 Retroreflective Paint	
	1 Preformed Retroreflective Tape, Type I (Removable)	
	2 Preformed Retroreflective Tape, Type II (Non-Removable)	
	3 Retroreflective Thermoplastic	
	4 Blank	
	5 Preformed Retroreflective Tape, Level I	
	6 Preformed Retroreflective Tape, Level II	
	B Type of Marking:	
	1 Line	Linear Foot
	2 Symbol	Square Foot
	CD Width of Line	
	04 4 in	Linear Foot
	06 6 in	Linear Foot
	08 8 in	Linear Foot
	12 12 in	Linear Foot
	16 16 in	Linear Foot
	18 18 in	Linear Foot
	24 24"	Linear Foot
	.911 Obliterate Pavement Marking, 12" Wide & Under	
	.912 Obliterate Pavement Marking, Over 12" Wide	

**Examples :**

632.0104	Retroreflective Paint Pavement Marking, Single Solid Line, 4 in	Linear Foot
632.3104	Retroreflective Thermoplastic Pavement Marking, Single Solid Line, 4 in	Linear Foot

**SECTION 641 -- LOAM****Description**

**1.1** This work shall consist of collecting and preparing loam material encountered in the work or obtained from other sources, and placing the material at the locations shown on the plans or ordered, including necessary excavation for placing loam.

**Materials**

**2.1** Loam shall consist of loose friable topsoil with no admixture of refuse or material toxic to plant growth. Loam shall be free of viable parts of prohibited invasive plants listed in Table 3800.1 of part AGR 3800. Loam shall be generally free from stones, lumps, stumps, or similar objects larger than 2" in greatest diameter, subsoil, roots, and weeds. The term as used herein shall mean that portion of the soil profile defined technically as the "A" horizon by the Soil Science Society of America. The minimum and maximum pH value shall be from 5.5 to 7.6. Loam shall contain a minimum of 3 percent and a maximum of 10 percent of organic matter as determined by loss by ignition. Not more than 65 percent shall pass a No. 200 sieve as determined by the wash test in accordance with ASTM D 1140. In no instance shall more than 20% of that material passing the No. 4 sieve consist of clay size particles.

**2.1.1** Natural topsoil not conforming to 2.1 or containing excessive amounts of clay or sand shall be treated by the Contractor to meet those requirements.

**Construction Requirements**

**3.1** The loam shall be spread upon the previously prepared subgrade surface to the depth of 4"  $\pm$  1/2" unless otherwise specified and shall be raked carefully to remove all objectionable materials. Loam shall be spread in such a manner as to establish a loose, friable seedbed. In order to maintain a consistent grade, loam placed adjacent to lawns or where directed shall be compacted with a roller weighing approximately 100 pounds per foot of roller width. All depressions exposed during the rolling procedure shall be filled with additional loam, and rolled.

**Method of Measurement**

**4.1** Loam will be measured by the cubic yard as determined by actual surface measurements of the lengths and widths of the loamed areas multiplied by the depth specified. Measurements will be made to the nearest 0.1 of a cubic yard.

**Basis of Payment**

**5.1** The accepted quantities of loam of the various depths specified will be paid for at the Contract unit price per cubic yard complete in place.

**5.2** Materials used for treating natural topsoil as in 2.1.1 will be subsidiary.

**Pay item and unit:**

641.	Loam	Cubic Yard
------	------	------------

**SECTION 641**

**SECTION 642 -- LIMESTONE**

**Description**

1.1 This work shall consist of furnishing and applying limestone on areas shown on the plans or ordered.

**Materials**

2.1 Limestone shall be a calcic or dolomitic ground agricultural limestone containing not less than 95 percent of either calcium or magnesium carbonate, or both. It shall conform to the standards of the Association of Official Agricultural Chemists and shall comply with all State and Federal rules and regulations.

2.1.1 **Sieve analysis.** A minimum of 40 percent shall pass a No. 100 sieve, and a minimum of 95 percent shall pass a No. 8 sieve.

2.1.2 **Packaging.** Limestone shall be furnished in new, clean, sealed, and properly labeled bags, of not more than 100 lb. each, with the following information clearly marked thereon:

- (a) Manufacturer's name.
- (b) Type.
- (c) Weight.
- (d) Guaranteed analysis.

2.1.2.1 Caked or otherwise damaged limestone may be rejected.

2.2 Other liming materials may be used if permitted.

**Construction Requirements**

3.1 Limestone shall be used when ordered, to raise the pH of the soil, at a rate determined by the Engineer in accordance with Table 642-1.

**Table 642-1 - Limestone Required to Raise Soil pH to a Minimum pH of 5.5**

Existing Soil pH	Limestone to Be Added	
	Tons/Acre	Pounds/Cubic Yard
4.0 - 4.4	3	12
4.5 - 4.9	2	8
5.0 - 5.4	1	4

3.2 Limestone shall be applied by either the dry or hydraulic methods specified in 644.3.5.

**Method of Measurement**

4.1 Limestone will be measured by the ton, in accordance with 109.01, on the basis of delivery slips forwarded to the Engineer, but not to exceed the rate ordered. Measurements will be made to the nearest 0.01 of a ton.

**Basis of Payment**

5.1 The accepted quantity of limestone will be paid for at the Contract unit price per ton complete in place.

**Pay item and unit:**

642.	Limestone	Ton
------	-----------	-----



**SECTION 643 -- FERTILIZER FOR GRASSES****Description**

**1.1** This work shall consist of furnishing and applying an initial application of fertilizer on a new surface and one or more refertilizations after the growth has progressed sufficiently, all as shown on the plans or as ordered.

**Materials**

**2.1** Fertilizer shall be a standard commercial grade fertilizer conforming to all State and Federal rules and regulations and to the standards of the Association of Official Agricultural Chemists. The analysis shall represent respective percentages of nitrogen, phosphoric acid, and potash.

**2.1.1** Except as permitted, the analysis ratio shall be 1:1:1 for initial application and 3:1:2 for refertilization application. The analyses in Table 643-1 are preferred. Permission to furnish fertilizer with an analysis varying from Table 643-1 will be based upon reasons given in writing by the Contractor requesting such variances.

**Table 643-1 - Fertilizer Information**

Percent of Nutrients		Minimum Application Rate Lbs Per 1,000 ft <sup>2</sup>	Measurement Factor
Initial	Refertilization		
10-10-10		20.0	1.0
15-15-15		13.4	1.5
19-19-19		10.5	1.9
	10-3-6	20.0	1.0
	12-2-8	16.7	1.2
	12-4-8	16.7	1.2

**2.1.2** A minimum of 30 percent of the nitrogen in fertilizer used for refertilization shall be water insoluble (WIN).

**2.2** All fertilizer shall be identified by labels and shall show the following:

- (a) Guaranteed analysis.
- (b) Name and address of the guarantor of the fertilizer.
- (c) Type or brand.
- (d) Net weight.

**2.2.1** When furnished as a liquid, the fertilizer shall be delivered in an appropriate container or vehicle, and shall conform to the pertinent sections of the Fertilizer Rules and Regulations issued by the New Hampshire Department of Agriculture.

**Construction Requirements**

**3.1** Fertilizer shall be uniformly applied by either the dry or hydraulic method specified in 644.3.5. When the dry method is used, special care shall be taken to thoroughly work the fertilizer into the soil.

**3.1.1** The rate of application shall be based upon the nitrogen content and shall be a rate between 2.0 and 2.2 pounds of nitrogen per 1,000 square feet. See Table 643-1 for typical application rates.

**3.2** Unless otherwise ordered, not less than three months shall elapse between the initial fertilization and the refertilization. No refertilization ordinarily will be allowed between November 1, or when the ground has frozen, and the following April 1, or between June 1 and the following September 1. Refertilization will be allowed between August 15 and 31 only when it is determined that the permanent grasses have developed well and few weeds have appeared, and such refertilization will not tend to promote the growth of noxious weeds.

**Method of Measurement**

**4.1** Fertilizer will be measured by the pound or by the ton, and in accordance with 109.01, on the basis of weight slips or delivery slips forwarded to the Engineer, but not to exceed the maximum rate specified or ordered. Measurements by the ton will be made to the nearest 0.01 of a ton.

**4.1.1** The quantity for payment will be the product of the accepted quantity used and the appropriate measurement factor from Table 643-1.

## SECTION 643

### Basis of Payment

5.1 The accepted quantity of fertilizer will be paid for at the Contract unit price per pound or per ton complete in place.

#### Pay items and units:

643.11	Fertilizer for Initial Application	Pound
643.12	Fertilizer for Initial Application	Ton
643.21	Fertilizer for Refertilization	Pound
643.22	Fertilizer for Refertilization	Ton

**SECTION 644 -- GRASS SEED****Description**

1.1 This work shall consist of furnishing and sowing grass seed as shown on the plans or as ordered.

**Materials****2.1 General.**

2.1.1 Grass seed shall meet the requirements of the New Hampshire Agricultural and Vegetable Seeds Law. As specified in the law, the mixture shall include no “primary noxious weed seeds”.

2.1.2 Grass seed of the specified mixtures shall be furnished in fully labeled, standard, sealed containers. Official seed tags and shipment invoices from seed suppliers shall be furnished to the Engineer with each seed delivery on the project.

2.1.3 Percent germination and purity of each seed type in the mixture and weed seed content of the mixture shall be clearly stated on the label.

2.1.4 Seed shall be subject to the testing provisions of the Association of Official Seed Analysts. The month and year of test shall be clearly stated on the label.

2.1.5 Seed may be tested after it has been delivered to the project to verify the seed tag information.

2.1.6 Seed which has become wet, moldy, or otherwise damaged will not be acceptable.

2.2 Park seed Type 15 shall be used on loam areas. This seed mixture shall conform to Table 644-1.

**Table 644-1 - Park Seed Type 15**

Kind of Seed	Minimum Purity (%)	Minimum Germination (%)	Pounds/Acre (Total 120 lbs)
Creeping Red Fescue <sup>c</sup>	96	85	40
Perennial Ryegrass <sup>a</sup>	98	90	50
Kentucky Bluegrass <sup>b</sup>	97	85	25
Redtop	95	80	5

2.3 Slope seed (WF) Type 45 shall be used for all slope work and shall conform to Table 644-2 unless amended by the Engineer to suit special local conditions encountered.

**Table 644-2 – Slope Seed (WF) Type 45**

Kind of Seed	Minimum Purity (%)	Minimum Germination (%)	Pounds/Acre (Total 95 lbs)
Creeping Red Fescue <sup>c</sup>	96	85	35
Perennial Ryegrass <sup>a</sup>	98	90	30
Redtop	95	80	5
Alsike Clover	97	90 <sup>e</sup>	5
Birdsfoot Trefoil <sup>d</sup>	98	80 <sup>e</sup>	5
Lance-Leaved Coreopsis	95	80	4
Oxeye Daisy	95	80	3
Blackeyed Susan	95	80	4
Wild Lupine	95	80	4

2.3.1 Slope seed Type 44 shall only be used where specified on the Plans, or as ordered, and shall conform to Table 644-3.

**Table 644-3 - Slope Seed Type 44**

Kind of Seed	Minimum Purity (%)	Minimum Germination (%)	Pounds/Acre (Total 80 lbs)
Creeping Red Fescue <sup>c</sup>	96	85	35
Perennial Ryegrass <sup>a</sup>	98	90	30
Redtop	95	80	5
Alsike Clover	97	90 <sup>(e)</sup>	5
Birdsfoot Trefoil <sup>d</sup>	98	80 <sup>(e)</sup>	5

## SECTION 644

### NOTES TO TABLES 1, 2 & 3:

- <sup>a</sup> Ryegrass shall be a certified fine-textured variety such as Pennfine, Fiesta, Yorktown, Diplomat, or equal.
- <sup>b</sup> Bluegrass shall be a certified variety such as Merion, Baron, Majestic Touchdown, Nugget, Ram One, or equal.
- <sup>c</sup> Fescue varieties shall include - Creeping Red and/or Hard Reliant, Scaldis, Koket, or Jamestown.
- <sup>d</sup> Empire variety preferred) Inoculum specific to birdsfoot trefoil must be used with this mixture. The inoculum shall be a pure culture of nitrogen-fixing bacteria selected for maximum vitality and the ability to transform nitrogen from the air into soluble nitrates and to deposit them in the soil. The inoculum shall not be used later than the date indicated on the container or later than specified. The inoculum shall be subject to approval.
- <sup>e</sup> Includes not more than 10 percent hard seed for alsike clover and not more than 25 percent hard seed for birdsfoot trefoil. If necessary, to meet this requirement, extra seed shall be supplied at no expense to the Department.

### Construction Requirements

#### 3.1 General.

**3.1.1** In order to prevent unnecessary erosion of newly graded slopes and unnecessary siltation of drainage ways, the Contractor shall carry out erosion control items of work such as seeding and mulching as soon as it has satisfactorily completed a unit or portion of the project, such as a structure, an interchange, or a section of roadway.

**3.1.2** When immediate protection of newly graded areas is necessary at a time which is outside of the normal seeding season, hay mulch shall be applied in accordance with 645.3.3, with the seeding done at the same time or done later, or both as ordered.

**3.1.2.1** When immediate seeding is required on areas of the roadside which are not to be regraded or disturbed, one of the above specified seed mixtures shall be used as ordered.

**3.1.2.2** Areas of the roadside which are to be left temporarily and which will be regraded or otherwise disturbed later during construction may be ordered to be seeded with ryegrass under Item 645.52 to obtain temporary control. Ryegrass shall be spread at the rate of approximately 1 pound per 1,000 square feet.

**3.1.3** The Engineer reserves the right to prohibit the use of any equipment that is unsuitable or inadequate for the proper performance of the work. The Contractor must immediately remove all rejected equipment from the project.

**3.1.4** When the seed mixture requires an inoculum, the inoculum shall be kept as cool as possible, at all times below 75 °F until used. Inoculated seed shall be protected from exposure to sunlight prior to sowing, and all seed not sown within 24 hours following inoculation shall be properly re-inoculated.

**3.1.4.1** When grass seed is to be sown dry and the specific legume seed such as birdsfoot trefoil requiring inoculation is furnished on the project separately from the balance of the seed mixture, the legume seed shall be inoculated using twice the normal quantity recommended by the supplier, and, regardless of the directions by the supplier, the seed shall be treated with a sticking agent to hold the inoculum to the seeds, and then treated with a drying agent. The sticking agent shall consist of a mixture such as 9:1 solution of water and molasses, which shall be thoroughly mixed with the seed at the rate of 1/2 pint per 100 pounds of seed, unless a greater rate is recommended by the supplier. Before mixing the treated seed with the remainder of the seed mixture, a drying agent such as cornstarch shall be added at the rate of approximately 1/2 pound per 100 pounds of seed, unless another rate is specified.

**3.1.4.2** When grass seed is to be sown dry and the legume seed is furnished on the project already mixed with the remainder of the seed mixture, 3 times the normal quantity of inoculant recommended by the supplier as sufficient for the quantity of legume in the mixture shall be mixed with the total seed. The sticking agent and the drying agent shall be mixed in the manner and at the rate specified in 3.1.4.1 with sufficient agents to treat the entire mixture.

**3.1.4.3** When the seed is to be applied by the use of a hydraulic seeder, at least 4 times the normal amount of the appropriate inoculum, required to inoculate only the legume shall be added to the mixture just before application. See 3.5.2.7.

#### 3.2 Seeding Seasons.

**3.2.1** Seeding and initial fertilizing shall be done between April 1 and June 1, between August 15 and October 14, or as permitted. Seeding shall not be done during windy weather or when the ground is frozen, excessively wet, or otherwise untiltable. If seeding is done during July or August, additional mulch material may be required by the Engineer.

**3.3 Application rates.** Unless specifically ordered, seed shall be spread at the rates specified in 2.2, 2.3, and 2.4.

#### 3.4 Preparation.

**3.4.1** All areas to be seeded shall be prepared to provide a reasonably firm but friable seed bed.

**3.4.1.1** Sloped areas shall not be left too smooth; the surface shall be left in a ruffled condition such as may be produced by the use of tracked vehicles run up and down the slopes. Smooth, compacted slopes, such as may have left from blading, which

might allow the free flow of water down them shall be disked, harrowed, dragged with a chain or mat, machine-raked, or hand-worked as directed to give the effect of miniature terraces, particularly in silty or clayey soils. The slopes shall be left smooth enough to enable mowing.

**3.4.1.2** Lawn areas, such as where loam has been spread, shall be prepared for seeding in accordance with [641.3.1](#).

**3.4.2** All areas to be seeded shall meet the specified grades and shall be free of growth and debris.

**3.4.3** Care shall be taken to prevent the formation of low places and pockets where water will stand.

**3.4.4** Where ryegrass has been planted for temporary erosion control and has not been eliminated prior to the completion of the work, such areas shall be disc-harrowed at least 3" deep and seeded with permanent grasses to prevent the ryegrass from reseeding and becoming competitive with and retarding development of the permanent cover.

### 3.5 Seeding methods.

Fertilizer, limestone, and mulch material if required, and seed of the type specified may be placed at the locations shown or ordered by one of the following methods, provided an even distribution is obtained.

#### 3.5.1 Dry Method.

**3.5.1.1 Power equipment.** Mechanical seeders, seed drills, landscape seeders, cultipacker seeders, fertilizer spreaders, or other approved mechanical seeding equipment or attachments may be used when seed, limestone, and fertilizer are to be applied in dry form.

**3.5.1.2 Manual equipment.** On areas which are inaccessible to power equipment, permission may be given to use hand-operated mechanical equipment when the materials are to be applied in dry form. The use of hand shovels to spread the materials will not be allowed.

**3.5.1.3** When the dry method is used, limestone and fertilizer may be mixed together prior to their application, and shall be worked into the soil to the depth of at least 1".

**3.5.1.4** Seeding may occur following this procedure.

**3.5.1.5** Loamed areas or areas covered with park seed shall be raked, and, unless rolling is ordered omitted, shall be rolled with a roller weighing not more than 100 pounds per foot of roller width to firm the soil but not to pack it. The rolling shall be done the same day as the seeding unless otherwise permitted.

**3.5.1.6** Unless otherwise ordered, areas covered with park seed, or slope seed shall be mulched in accordance with [Section 645](#). Private lawns affected by this specification need not be mulched unless it is requested by the landowner.

#### 3.5.2 Hydraulic Method.

**3.5.2.1** The application of grass seed, fertilizer, limestone, and a suitable wood fiber mulch shall be accomplished in one operation by use of an approved spraying machine.

**3.5.2.2** The materials shall be mixed with water in the machine and kept in an agitated state in order that the materials may be uniformly suspended in the water.

**3.5.2.3** The spraying equipment shall be so designed that when the solution is sprayed over an area, the resulting deposits of limestone, fertilizer and grass seed shall be equal in quantity to the required rates.

**3.5.2.4** Prior to the start of work, the Engineer shall be furnished with a certified statement for approval as to the number of pounds of materials to be used per 100 gallons of water. This statement shall also specify the number of square feet of seeding that can be covered with the quantity of solution in the hydroseeder.

**3.5.2.5** The hydroseeder shall be completely flushed and cleaned each day before seeding is to be started, and shall also be thoroughly flushed of all residue after the completion of application on every 10 acres.

**3.5.2.6** If the results of the spray operations are unsatisfactory, the Contractor will be required to abandon this method and apply the materials in accordance with 3.5.1.

**3.5.2.7** When inoculum is required, if the inoculum is left in solution with fertilizer longer than 30 minutes, a fresh charge of inoculum (4 times normal) shall be added to the mixture. See 3.1.4.3.

**3.5.2.8** When the hydraulic method is used, compaction or rolling will not be required.

**3.5.2.9** Except as provided in 3.1.2, unless mulch material required is applied during the seeding operation or within 1/2 hour following the seeding operation, temporary and satisfactory measures to protect the seed from sunlight and heat shall be taken, such as the use of a light brush drag over the seeded areas to stir the seed into the soil. Care shall be taken not to carry the seed ahead.

## SECTION 644

### 3.6 Care After Seeding.

**3.6.1** The Contractor shall be responsible for protecting and caring for seeded areas until Acceptance of the Work. He shall repair at his own expense any damage to seeded areas caused by pedestrian or vehicular traffic or other causes, except for conditions as covered in 104.13.

**3.6.2** If necessary, barricades of brush or other materials and suitable signs shall be placed to protect the seeded areas.

**3.6.3** The seeded areas shall be carefully and suitably watered as necessary to produce a satisfactory growth.

**3.6.4** Areas seeded with park seed shall be mowed whenever necessary to keep the growth between 3 and 6" in order to allow light to penetrate to the shorter, slower growing species in the mixture. Areas seeded with slope seed may be ordered mowed whenever the Contract extends into a second growing season.

**3.6.5** Weeds growing in areas seeded with the slope seed shall be cut back to prevent them from dominating the desired grass plants.

### 3.7 Liability.

**3.7.1** The Contractor shall keep all seeded areas in good repair.

**3.7.2** To be acceptable, a stand of grass shall show a reasonably thick, uniform stand, free from sizable areas of thin or bare spots, with a uniform count of at least 100 plants of specified grass per square foot. When applicable, at least 3 birdsfoot trefoil plants per square foot must be visible with the other specified grasses.

**3.7.3** Any part of seeded areas which fail to yield an acceptable stand shall be retreated with additional seed, limestone, fertilizer and mulch as ordered at no cost to the Department.

#### Method of Measurement

**4.1** Grass seed shall be measured by the pound based upon the delivery slips and tags furnished the Engineer, but not to exceed the rate specified or ordered.

#### Basis of Payment

**5.1** The accepted quantity of grass seed will be paid for at the Contract unit price per pound of the type specified complete in place.

**5.1.1** Seeded areas which need reseeding will be done at the Contractor's expense.

**5.2** Hay mulch will be paid for as provided under [Section 645](#).

**5.3** Limestone will be paid for as provided under [Section 642](#).

**5.4** Fertilizer will be paid for as provided under [Section 643](#).

**5.5** Ryegrass will be paid for as provided under [Section 645](#).

#### Pay items and units :

644.15	Park Seed Type 15	Pound
644.44	Slope Seed Type 44	Pound
644.45	Slope Seed (WF) Type 45	Pound
644.51	Birdsfoot Trefoil	Pound

**SECTION 645 -- EROSION CONTROL****Description**

**1.1 Erosion Control Products.** This work shall consist of furnishing and placing hay mulch, bark mulch, “Rolled Erosion Control Products” (RECP), or other material, to provide soil stabilization and/or erosion control on slopes or in channels at locations shown on the plans or where ordered.

**1.1.1 Temporary Slope Stabilization Type A** shall be a temporary, photodegradable or biodegradable RECP specified for protection of slopes of 3:1 or flatter. This material may also be specified for temporary protection of channels expected to experience flow-induced shear of 1.5 lbs/ft<sup>2</sup> or less. These products shall maintain their functional integrity for a minimum of 12 months and then degrade.

**1.1.2 Temporary Slope Stabilization Type B (Wildlife friendly)** shall be a temporary, biodegradable RECP specified for protection of slopes of 3:1 or flatter in areas where wildlife ensnarement is a concern. This material may also be specified for temporary protection of channels expected to experience flow-induced shear of 1.5 lbs/ft<sup>2</sup> or less. These products shall maintain their functional integrity for a minimum of 12 months and then biodegrade.

**1.1.3 Temporary Slope Stabilization Type C** shall be a temporary, photodegradable or biodegradable RECP specified for protection of slopes of 1½:1 or flatter. This material may also be specified for temporary protection of channels expected to experience flow-induced shear of 2.0 lbs/ft<sup>2</sup> or less. These products shall maintain their functional integrity for a minimum of 12 months and then degrade.

**1.1.4 Temporary Slope Stabilization Type D (Wildlife friendly)** shall be a temporary, biodegradable RECP specified for protection of slopes of 1½:1 or flatter in areas where wildlife ensnarement is a concern. This material may also be specified for temporary protection of channels expected to experience flow-induced shear of 2.0 lbs/ft<sup>2</sup> or less. These products shall maintain their functional integrity for a minimum of 12 months and then biodegrade.

**1.1.5 Permanent Channel Stabilization Type A** shall be a permanent “Turf Reinforcement Mat” (TRM) specified for permanent protection of channels or ditches that are expected to experience flow-induced shear of 3.0 lbs/ft<sup>2</sup> or less.

**1.1.6 Permanent Channel Stabilization Type B** shall be a permanent TRM specified for permanent protection of channels or ditches that are expected to experience flow-induced shear of 5.0 lbs/ft<sup>2</sup> or less.

**1.2 Storm Water Pollution Prevention Plan (SWPPP).** This work shall consist of a temporary erosion and sediment control and storm water management plan, hereinafter called the Storm Water Pollution Prevention Plan or “SWPPP”. The work includes all necessary preparations for submissions and revisions of the SWPPP to obtain approval by the Department. This work shall also include monitoring the approved SWPPP during all phases of construction.

**1.2.1** The Department will furnish the following data to the Contractor:

- Specific reproducible plan sheets and cross-sections of the project, as requested.
- Drainage calculations and plans (drainage area size and characteristics; runoff volume; type, size, and slope of pipes; invert elevations; and outlet velocities), as available.
- Geotechnical Report including soil boring logs, soil types, and test pit data, as available.
- Permits and certifications obtained for the project.
- A list of environmental commitments.
- A copy of the NHDOT’s Notice of Intent application.
- A copy of the NHDOT’s Acknowledgement letter from EPA.
- Documentation of permit eligibility related to federally listed threatened and endangered species.
- NHDES Wetlands Permit “Plan of Record”.

**1.2.2** Recommended guides for the preparation of the SWPPP are the National Pollutant Discharge Elimination System (NPDES) Construction General Permit (CGP), **June 30th, 2008 (73 FR 40338)**. The AASHTO Highway Drainage Guideline, Volume III, *Guidelines for Erosion and Sediment Control in Highway Construction*, available from the American Association of State Highway and Transportation Officials, Inc., 444 North Capitol St. N.W., Suite 249, Washington, D.C. 20001; the *New Hampshire Stormwater Management Manual, Volume 3, Construction Phase Erosion and Sediment Controls* available from the New Hampshire Department of Environmental Services (NHDES) Public Information and Permitting Office, PO Box 95, 6 Hazen Drive, Concord, NH 03302-0095, Telephone (603) 271-2975 and the Rockingham County Conservation District in Exeter, NH, Telephone (603) 772-4385; the NHDOT Guidelines for Temporary Erosion and Sediment Control and Stormwater Management (May 2002).

**1.2.3** The SWPPP shall be consistent with the provisions of 107.01.

## SECTION 645

### Materials

#### 2.1 Mulch

**2.1.1** Hay mulch shall consist of cured hay, free from noxious weeds including prohibited invasive plants listed in Table 3800.1 of Part AGR 3800 and rough or woody materials.

**2.1.2** Bark mulch shall be bark chippings graded to be approximately 3/8 to 2" in width. The chippings shall not have been stored so long and under such conditions that the material has decomposed sufficiently so that it has lost its fibrous texture. Bark mulch must be approved as to grading and condition prior to its use.

**2.1.3** Temporary mulches shall be hay, straw, fiber mats, netting, wood cellulose, bark, chips, or other approved material. The mulch shall be reasonably clean and free of noxious weeds and materials toxic to plant growth.

**2.2** Slope and channel stabilization products of the type specified shall be a Rolled Erosion Control Product (RECP) that is listed on the [Qualified Products List](#).

**2.3** Staples for soil stabilization material matting shall be those specified by the manufacturer.

**2.4** Grass seed for erosion control shall be one of the following:

- (a) Seed for temporary control shall be a quick growing species suitable to the area, such as annual or perennial ryegrass, providing a temporary cover which will not compete with the grasses subsequently sown for permanent cover.
- (b) Seed for a more permanent control shall be of the type specified in the plans or as set forth in 644.2.3.

**2.5** Hay bales for erosion control shall consist of rectangular shaped bales of hay or straw weighing at least 40 lb. per bale. They shall be free from weed seeds and viable parts of prohibited invasive plants listed in Table 3800.1 of pPart AGR 3800 and rough or woody materials.

**2.6** Tackifiers shall be as included on the [Qualified Products List](#).

**2.7** Geotextile filter fabric for silt fence shall be made from polypropylene, polyester, or other approved polymeric chemically stable material and resistant to ultraviolet radiation degradation for at least 12 months. Silt retention capacity shall be no less than 75 percent of silt and suspended solids. The fabric shall meet the following requirements.

<b>Fabric Property</b>	<b>Test Method</b>	<b>Property Requirement*</b>
Grab Tensile Strength (lbs)	ASTM D 4632	100 Minimum
Grab Tensile Elongation (%)	ASTM D 4632	25 Maximum
Puncture Strength (lbs)	ASTM D 4833	60 Minimum
Mullen Burst Strength (psi)	ASTM D 3786	210 Minimum
Trapezoid Tear Strength (lbs)	ASTM D 4533	60 Minimum

\*All properties are minimum or maximum average roll values (i.e. the test results for any sampled roll in a lot shall meet or exceed the minimum values or be less than or meet the maximum value in the table.)

**2.8** Posts for silt fence shall be either wood or steel. Wood posts shall be sound quality hardwood with a minimum cross sectional area of 1.6 sq. in. Steel post shall be standard T or U section weighing not less than 1 pound per linear ft. with projections for fastening wire to the fence. Maximum post spacing shall be 10 ft.

**2.9** Support fence for silt fence, if required, shall be a minimum of 14.5 gauge woven wire with a maximum 6" mesh.

**2.10** Erosion stone shall meet the requirements for Item 585.4 Class D stone.

#### 2.11 Erosion Control Mix

**2.11.1** Erosion control mix shall be placed to provide for temporary control of erosion or sedimentation, including slope stabilization, check dams and berms, inlet control or where ordered.

**2.11.2** The mix shall have an organic portion between 25% and 65%, dry weight basis, and be fibrous and elongated such as from shredded bark, stump grindings, composted bark, or equivalent manufactured products. The mix shall not contain silts, clays, or fine sands.

**2.11.3** The mix shall have a pH between 5.0 and 8.0 and a particle size by weight of 100% passing a 3-inch screen, 90% to 100% passing a 1-inch screen, 70% to 100% passing a 0.75-inch screen, and 30% to 75% passing a 0.25-inch screen.



## Construction Requirements

### 3.1 General

**3.1.1** Prior to the start of any land disturbance activities, the Contractor shall submit four sets of the Storm Water Pollution Prevention Plan (SWPPP) described in 3.2 for approval in accordance with 105.02 for clearing, grubbing, grading, drainage and bridge structures, especially in or adjacent to existing waters, water courses and wetlands. The Department's review time will be proportional to the complexity of the SWPPP and will be within 15 working days. No work requiring erosion/ sediment control shall commence until the SWPPP has been approved. Names of designated personnel to perform field monitoring shall be included in the submittal. The SWPPP may be submitted in phases or for specific construction areas addressing the maximum open area allowed in section 3.1.4. Only work within areas covered by an approved SWPPP will be allowed to be performed.

**3.1.1.1** The Department will secure the necessary NHDES Wetlands or US Army Corps of Engineers permit(s) to accomplish the work indicated on the plans. The Contractor is responsible for obtaining additional Wetlands or Corps of Engineers permit(s) for the Contractor's method of construction.

**3.1.2** Permanent and temporary erosion control features shall be incorporated into the project at the earliest practicable time, as specified on the plans, as stated in 107.01, and as outlined in the approved SWPPP. Temporary erosion and sediment control measures shall be used to correct conditions that develop during construction to temporarily control erosion not associated with permanent control features.

**3.1.3** When erosion is likely to be a problem, grubbing operations shall be so scheduled and performed that grading operations and permanent erosion control features can follow immediately thereafter.

**3.1.4** The maximum amount of allowed disturbed earth material exposed shall not exceed a total of 5 acres for all operations within the right-of-way at any one time. The Contractor may be permitted to exceed the maximum open area allowed, with approval from the Department, provided the Contractor's SWPPP shows adequate provisions to control erosion and sediment, provided the additional area of disturbance is necessary to meet the Contractor's Critical Path Method schedule (CPM), and the Contractor can demonstrate there are adequate resources available (equipment & manpower) to respond to multiple events simultaneously. In addition, the SWPPP shall show stabilization procedures for any areas that are inactive for more than fourteen days. The SWPPP shall identify when exposed material will be protected from erosion and when temporary and permanent erosion control measures will be installed.

**3.1.5** For the construction period from November 30<sup>th</sup> through May 1<sup>st</sup> the area of exposed, unstablized soil shall be limited to one acre. The allowable area of exposed soil may be increased provided a winter construction plan shows adequate provisions to control erosion and sediment, provided the additional area of disturbance is necessary to meet the Contractor's Critical Path Method schedule (CPM), and the Contractor can demonstrate there are adequate resources available (equipment & manpower) to respond to multiple events simultaneously and is reviewed and approved by the Department.

**3.1.6** The Engineer will limit the area of clearing, grubbing, excavation, borrow and embankment operations commensurate with the Contractor's capability and progress and in no case shall exceed a total of 5 acres without prior approval, in keeping the finish grading, mulching, seeding, erosion and sediment control measures concurrent with operations in accordance with the accepted SWPPP.

**3.1.7** Earth excavation and embankment slopes shall be permanently or temporarily treated for stabilization before the time the slant height of exposed slopes reaches 30 ft., unless otherwise approved. Where construction activities are completed within the growing season, all exposed soil areas shall be permanently stabilized within 3 calendar days. Where construction activities are temporarily suspended or completed outside of the growing season, all exposed soil areas shall be treated for stabilization within 14 calendar days.

**3.1.8** An area shall be considered "stabilized" when it is in a condition in which the soils on the site will not erode under the conditions of a 10-year storm.

**3.1.9** As work progresses, patch seeding and mulching shall be done as required on areas previously treated to maintain or establish protective cover.

**3.1.10** Drainage pipes and ditches shall be constructed in a sequence from outlet to inlet in order to stabilize outlet areas and ditches before water is directed to the new installation or any portion thereof unless conditions unique to the location warrant an alternative method. If this unique condition exists, the alternative method will require written approval.

**3.1.11** Channel and ditch work, including erosion protection shall be completed before diverting the drainage to these areas.

**3.1.12** In the event of conflict between these requirements and erosion and sediment control laws, rules or regulations of other Federal, State or local agencies, the more restrictive laws, rules or regulations shall apply.

## SECTION 645

**3.1.13** In case of failure on the part of the Contractor to provide and maintain effective temporary erosion and sediment control, as determined by the Engineer, the Department reserves the right to employ outside assistance or to use its own forces to provide the necessary corrective measures.

### **3.2 Storm Water Pollution Prevention Plan. (SWPPP)**

**3.2.1** This Item addresses the preparation and implementation of a SWPPP required by the National Pollutant Discharge Elimination System (NPDES) and applicable Construction General Permit (CGP). The SWPPP shall be prepared, stamped and signed by a Licensed Professional Engineer registered in the State of New Hampshire, and a Certified Professional Erosion and Sediment Control Specialist (CPESC), qualified to prepare erosion and sediment control plans, hereinafter called the "Preparer". Collaboration with other professionals such as soil scientists, geologists and environmentalists may be required as appropriate.

**3.2.1.1** Qualifications for the SWPPP Preparer include a minimum of 5 years' experience or knowledge of highway and bridge construction operations, with knowledge of methods of construction, demonstrated knowledge of erosion and sediment control, and stormwater management measures. The preparer shall have previously submitted accepted plans to the New Hampshire Department of Environmental Services (NHDES) under RSA 485-A:17 Terrain Alteration, or have prepared accepted plans under the National Pollutant Discharge Elimination System permit program.

**3.2.1.2** The Preparer may monitor the SWPPP or designate a representative to monitor the SWPPP. If the Preparer chooses to utilize a representative, the SWPPP Monitor shall be certified as a Certified Erosion Sediment and Storm Water Inspector (CESSWI) with knowledge of methods of construction, demonstrated field knowledge of erosion control measures; their design, effectiveness, and maintenance requirements.

**3.2.1.3** The Contractor shall submit the name and qualifications of the person or firm proposed to prepare the SWPPP to the Engineer for approval prior to preparing the SWPPP. Submittal of the name and qualifications will be accepted after the opening of bids.

**3.2.2** The Construction General Permit (CGP) also requires the preparation and implementation of a SWPPP in accordance with the afore mentioned statutes and regulations. The SWPPP will include the CGP conditions and detailed descriptions of controls of erosion and sedimentation to be implemented during construction. It is the responsibility of the Contractor to prepare the SWPPP to meet the requirements of the most recently issued CGP. The Contractor shall submit the SWPPP to the Engineer for approval prior to any soil disturbance activities. It is the responsibility of the Contractor to be familiar with the CGP conditions and the conditions of any state Wetlands permit, Water Quality Certification, Corps of Engineers Section 404 Permit and other state and federal environmental permits applicable to this project and to include in the SWPPP the means and methods necessary to comply with applicable conditions of said permits.

It is the responsibility of the Contractor to complete the SWPPP in accordance with the EPA Construction General Permit, provide all information required, and obtain any and all certifications as required by the Construction General Permit. Any amendments to the SWPPP required by site conditions, schedule changes, revised work, construction methodologies, and the like are the responsibility of the Contractor. Amendments will require the approval of the Engineer prior to implementation.

The Contractor is responsible for preparation of the SWPPP, all SWPPP certifications, inspections, reports and any and all corrective actions necessary to comply with the provisions of the CGP.

**3.2.2.1** A schedule of construction phasing, including maximum open area allowed, and a schedule for monitoring and maintaining the SWPPP shall also be included. BMP's for seasonal (i.e. cold weather/frozen ground, from November 30<sup>th</sup> through May 1<sup>st</sup>) applications shall be identified. The construction phasing shall address the various erosion and sediment control and storm water management measures to be implemented at each phase of construction. Phases shall be as shown on the Traffic Control Plan, Prosecution of Work, or as required by the Contractor's approved construction sequence plan.

**3.2.2.2** Turbidity limitations in receiving waters noted in 107.01 shall be addressed in the SWPPP.

**3.2.2.3** Department plan drawings will show the construction site(s) conditions prior to and after construction by including property lines, right-of-way lines, easements, existing and new structures, drainage, flood plains, wetlands, limits of clearing and grading, proposed final drainage, detours, permanent erosion and sediment control measures, and other critical items. The Contractor's plan drawings shall show temporary drainage and erosion and sediment control measures for the construction site(s) on the Contract plans provided by the Department. Additionally, the Contractor shall provide plans showing all of the above items for proposed areas related to the construction site(s) not shown on the Department's Contract plans, including but not limited to, access and haul roads, equipment and material storage sites, material pits, material processing sites, and disposal areas, except municipally authorized landfill areas and commercial sites. Waste materials are quite often materials unsuitable for embankment construction and generally very susceptible to erosion; therefore, the Contractor shall pay close attention to controlling erosion of these materials.

**3.2.2.4** Additional design typicals illustrating practices for erosion and sediment control not shown on the Department plans shall be included in the SWPPP. Calculations shall be included to verify all erosion and sediment control and stormwater

management practices such as, but not limited to, sediment retention and detention basins, energy dissipaters, diversions, waterways, and control of runoff.

**3.2.3** The Preparer or the Preparer's designated representative shall assist the Contractor in implementing the SWPPP, monitor the site for compliance with the SWPPP and recommend modifications to the SWPPP for changing operations or inadequate erosion and sediment control and stormwater management measures and shall attend weekly (or as required by the Engineer) meetings. The Preparer shall make modifications to the SWPPP as necessary and resubmit for review and approval in accordance with 3.1.1. Review time of modifications will be within 10 working days of submittal.

**3.2.3.1** Monitoring SWPPP and Erosion and Sediment Control shall include on-site reviews, weekly (at least once every 7 days) and within 24 hours after any storm event greater than 0.25" of rain per 24 hour period and producing meeting minutes of the weekly meetings for distribution as required. A monitoring report prepared by the SWPPP Monitor shall include the following:

- inspection date
- name
- title
- qualifications and signature of person performing the inspection
- weather information for the period since the last inspection
- weather information at the time of inspection
- list of site deficiencies or non-compliance issues
- locations and description of any discharges
- a summary of construction activities undertaken during the reporting period
- general site conditions
- erosion control maintenance and corrective actions taken
- the anticipated schedule of construction activities for the next reporting period
- any SWPPP amendments
- representative photographs

The weekly on-site review shall be conducted only when the Contractor's personnel are on site. Should any deficiencies or non-compliance issues be found, corrective action shall be performed in accordance with the USEPA and Construction General Permit (CGP). The SWPPP Monitor shall report any deficiencies or non-compliant issues to the Contractor and Engineer prior to exiting the site.

Within 24 hours of completing the on-site review, the SWPPP Monitor shall provide a formal written copy of the monitoring report to the Engineer to be maintained on file with the SWPPP at the project site.

**3.2.3.2** The Engineer may order modifications to the SWPPP for changing operations or for inadequate erosion and sediment control and stormwater management measures. Changes and/or modifications shall be noted by the SWPPP Preparer on the approved SWPPP located at the project site.

**3.2.3.3** The Preparer of the SWPPP shall be available for on-site consultations with the Engineer within 24 hours of request.

**3.2.4** Project work may be suspended, wholly or in part, with no extension of time or additional compensation for failure to implement and maintain the approved SWPPP, including modifications, in accordance with 105.01.

### 3.3 Mulch

**3.3.1** Mulching shall be done immediately after each area has been properly prepared. When seed for erosion control is sown prior to placing the mulch, the mulch shall be placed on the seeded areas within 48 hours after seeding. Hay that has been thoroughly fluffed shall be applied at approximately, but not to exceed 3 tons per acre unless otherwise ordered. Blowing chopped hay mulch will be permitted provided the Contractor controls the mulching operation so as not to infringe on property owners or the traveling public. Hay mulch shall be applied in such a manner that results in a minimum amount of matting that would not retard the vegetative growth. Hay mulch should cover the ground enough to shade it, but the mulch should not be so thick as to cover the ground completely. Matted or bunches of mulch shall be removed or otherwise remedied.

**3.3.1.1** Temporary mulching shall be done on areas that are disturbed per 3.1.6. Hay shall be applied at a minimum of 3.2 tons per acre unless otherwise ordered. Blowing chopped hay mulch will be permitted provided the Contractor controls the mulching operation so as not to infringe on property owners or the traveling public. Tackifiers shall be utilized with temporary mulch.

**3.3.2** In order to prevent mulch from being blown away, a light covering of loose branches or approved tackifier shall be employed. Unless otherwise ordered, loose branches shall be removed prior to Acceptance of the Work.

**3.3.3** All baling wire or rope, such as that used in the shipment of mulch shall be disposed of outside the limits of the project in approved areas.

## SECTION 645

**3.3.4** Bark mulch shall be placed on the designated areas to the depth specified on the plans or as ordered.

**3.3.5** On areas treated with bark mulch, the Contractor shall remove weeds and plant material as directed.

### 3.4 Rolled Erosion Control Products (RECP)

**3.4.1** Rolled Erosion Control Products (RECP), of the type specified, shall be installed where shown on the plans or as directed by the Engineer.

**3.4.2** RECPs for slope and channel stabilization shall be installed as per the manufacturer's recommendations for the specific application and site conditions, or as directed by the Engineer. Documentation from the manufacturer describing recommended installation procedures shall be provided to the Engineer at least 10 working days prior to installation.

**3.4.3** Surfaces of ditches and slopes to receive RECPs shall conform to the grades and cross sections shown on the plans and shall be finished to a smooth and even condition with all debris, roots, stones, and lumps raked out and removed. Unless otherwise directed, soil shall be prepared, including the application of lime, fertilizer and seed, prior to installation of the specified type of RECP.

**3.4.4** The RECP shall be placed so that is in intimate contact with the soil surface over the entire installation. Site conditions may require the use of additional staples to assure that this contact is maintained. The RECP shall not be stretched.

**3.4.5** RECPs shall be buried at the top of slope and around the edges of catch basins and other structures or obstructions as recommended by the manufacturer.

**3.4.6** In the event that the RECP installation becomes damaged, undermined, or raised off of the soil surface by vegetation, it shall be repaired immediately as per manufacturer's recommendations.

### 3.5 Seed for Erosion Control.

**3.5.1** Seeding, when required, shall be performed as ordered and in accordance with 644.3.

**3.5.1.1** Areas of the roadside which are to be left temporarily and which will be regraded or otherwise disturbed later during construction may be ordered to be seeded with ryegrass to temporarily stabilize the area. The seed shall be sown at the rate of approximately 1 pound per 1,000 square feet.

**3.6 Hay bales for erosion control.** Hay bales shall be placed when ordered to provide for temporary control of erosion and/or sediment control and secured with two (2) hardwood stakes. Bales shall be removed or left in place as ordered.

### 3.7 Silt Fence.

**3.7.1** Install and remove the silt fence as shown on the plans and as recommended by the manufacturer.

**3.7.1.1** When two sections of silt fence adjoin each other, they shall be overlapped by 6", folded, and stapled at a post.

**3.7.1.2** Support fence, when required, shall be fastened securely to the fence posts with staples or wire ties.

**3.7.1.3** Filter fabric shall be fastened to the support fence, when support fence is required, with ties spaced every 2 ft. longitudinally at the top, mid-section, and bottom.

**3.7.1.4** Silt fence shall be embedded a minimum of 6".

**3.7.2** Care shall be taken to maintain the silt fence in a functional condition at all times during the construction period.

**3.7.2.1** Silt fences shall be inspected immediately after each rainfall event and at least daily during prolonged rainfall. All deficiencies shall be immediately corrected.

**3.7.2.2** Sediment deposits shall be inspected after every storm event and removed when deposits reach approximately 1/3 the height of the silt fence, or when "bulges" develop in the silt fence.

**3.7.2.3** Silt fence fabric which has decomposed, has become ineffective or does not retain silt or suspended solids and is still needed, shall be replaced immediately.

**3.7.3** Remove the silt fence, support stakes and support fence after all work has been completed and it is no longer needed or as ordered.

**3.7.3.1** Sediment deposits shall be removed or left in place, if approved. After the silt fence has been removed, sediment deposits allowed to be left in place shall be graded to conform with the existing topography and shall be vegetated.

**3.7.3.2** The silt fence will become the property of the Contractor upon completion of the project, unless otherwise ordered.

### 3.8 Erosion Stone.

3.8.1 Erosion stone shall be placed to provide for temporary control of erosion or sedimentation including stone check dams, inlet control and stabilized construction entrances or where ordered. Upon acceptance of the Contract, the stone shall be removed as ordered.

### 3.9 Maintenance.

3.9.1 Erosion control features shall be maintained by the Contractor throughout the life of the project.

#### Method of Measurement

4.1 Mulch and temporary mulch will be measured by the square yard or by the acre. When measurements are made by the acre, such slope measurements will be made to the nearest 0.01 of an acre.

4.1.1 Bark mulch will be measured by the square yard measured along the slope of the ground.

4.2 Rolled Erosion Control Products (RECP) will be measured by the square yard, based on the dimensions of the exposed surface area of the product.

4.3 Grass seed will be measured by the pound, as specified in 644.4.1.

4.4 Hay bales for erosion control will be measured by the number of bales installed.

4.5 The silt fence will be measured by the linear foot to the nearest 1/2 ft. Measurement will be along the top of the fence for each continuous run in place with no allowance for splices or overlaps.

4.6 Storm Water Pollution Prevention Plan will be measured as a unit. A unit will include preparation, submittals, modifications, and resubmittals.

4.7 Monitoring SWPPP and Erosion and Sediment Controls will be measured to the nearest 1/2 hour, for the actual number of authorized hours spent monitoring the construction site(s) and offsite areas specified in 3.2 and on-site summary monitoring report preparation and distribution. The minimum field time measurement will be 2.0 hours. Monitoring Erosion and Sediment Control will not be measured when there is no item for this work.

4.7.1 Travel time and other time not spent at the construction site(s) or off-site areas specified in 3.2.3.1 and time not authorized will not be measured, except that, with prior authorization, up to 1 hour will be measured for off-site consultation, information review and final recommendation, preparation and distribution of the accepted final Monitoring Report.

4.8 Erosion stone will be measured per ton in accordance with 109.01.

4.9 Erosion Control Mix will be measured per CY in accordance with 109.01.

#### Basis of Payment

5.1 The accepted quantities of erosion control work will be paid for at the Contract unit price per square yard or per acre for mulch and per square yard for Rolled Erosion Control Products (RECP), complete in place.

5.2 Slope seed ordered for permanent erosion control and ryegrass ordered for temporary erosion control will be paid for as provided under 644.

5.3 Hay bales for erosion control will be paid for at the Item Bid Price per bale complete in place. No extra payment will be made for removal of bales ordered removed.

5.4 Tackifiers approved for use in 3.3.2 will be subsidiary.

5.5 The accepted quantity of silt fence and replacements as ordered will be paid for at the Contract unit price per linear foot installed.

5.5.1 Removing sediment deposits will be paid for under 699.

5.6 The accepted Storm Water Pollution Prevention Plan (SWPPP) will be paid for at the Contract lump sum price. Initial payment will be up to 60 percent of the amount bid upon approval of the SWPPP for the entire project. Subsequent payments will be made periodically based on the anticipated construction period and proposed construction sequence.

5.6.1 Modifications and resubmittals of the plan will be subsidiary.

5.7 The accepted quantities of Monitoring SWPPP and Erosion and Sediment Controls will be paid for at the Contract unit price per hour.

5.7.1 Travel time and other time not spent at the construction site(s) or off-site areas and support services (i.e. travel expenses, clerical staff, copying, miscellaneous expenses, overhead) except as stated in 4.6.1.1, will be subsidiary to Item 645.71.

## SECTION 645

**5.7.2** Erosion and Sediment Control and Stormwater Management items necessary to implement and maintain the Storm Water Pollution Prevention Plan (SWPPP) for the construction site(s) will be paid for under the appropriate Items of 645 or as provided under Section 699.5.

**5.8** The accepted quantity of erosion stone will be paid for at the Contract unit price per ton delivered to the project, complete in place, including any required excavation and stone removal, as ordered.

**5.9** The accepted quantity of erosion control mix will be paid for at the Contract unit price per CY. delivered to the project, complete in place, including any required stump grinding, excavation, as ordered.

**5.10** The Contractor shall maintain areas with permanent control, with no extra compensation, until the completion of the Contract.

**5.10.1** Repair and maintenance of damaged or failed slopes, until project acceptance as stated in section.

**5.10.2** The Department reserves the right to employ outside assistance or to use its own forces to provide the necessary corrective measures and deduct the cost from money due the Contractor and/or withhold progress payments.

### Pay items and units:

645.111	Mulch	Square Yard
645.11	Mulch	Acre
645.12	Temporary Mulch	Acre
645.15	Bark Mulch ___ in. Deep	Square Yard
645.3	Erosion Stone	Ton
645.41	Temporary Slope Stabilization Type A	Square Yard
645.42	Temporary Slope Stabilization Type B (Wildlife Friendly)	Square Yard
645.43	Temporary Slope Stabilization Type C	Square Yard
645.44	Temporary Slope Stabilization Type D (Wildlife Friendly)	Square Yard
645.54	Permanent Channel Stabilization Type A	Square Yard
645.46	Permanent Channel Stabilization Type B	Square Yard
645.48	Erosion Control Mix	Cubic Yard
645.51	Hay Bales for Temporary Erosion Control	Each
645.52	Ryegrass for Temporary Erosion Control	Pound
645.531	Silt Fence	Linear Foot
645.532	Silt Fence with Support Fence	Linear Foot
645.7	Storm Water Pollution Prevention Plan	Unit
645.71	Monitoring SWPPP and Erosion and Sediment Controls	Hour

**SECTION 646 -- TURF ESTABLISHMENT****Description**

- 1.1 This work shall consist of preparing the soil and furnishing and applying seed of the type or types specified, fertilizer, limestone, and mulch if required, on all areas designated for turf establishment as shown on the plans or ordered.
- 1.2 This work shall also consist of furnishing and placing humus or loam as specified in the item description.

**Materials**

- 2.1 Limestone shall conform to 642.2.
- 2.2 Fertilizer shall be that for initial fertilization and shall conform to 643.2.
- 2.3 Seed shall conform to 644.2 using the type of mixture(s) ordered.
- 2.4 Mulch shall conform to 645.2.1.
- 2.5 Mulch tackifiers shall conform to 645.2.6 and be environmentally non-toxic.
- 2.6 Humus shall conform to 647.2.
- 2.7 Loam shall conform to 641.2.

**Construction Requirements**

- 3.1 Construction requirements shall conform to 641.3, 643.3, 644.3, 645.3 and 647.3.
- 3.2 Application rate of limestone shall generally be 130 pounds per 1,000 square feet, approximately 3 tons per acre, unless otherwise ordered.
- 3.3 Mulch tackifiers shall be used as a tie-down or adhesive for mulch, it shall be used at the rate specified by the manufacturer, and applied uniformly over and through the mulch.

**Method of Measurement**

- 4.1 Turf establishment of the type specified will be measured by the acre or the square yard to the nearest 0.01 of an acre or nearest square yard from measurements taken on the ground surface covered.
- 4.2 Turf establishment (F) of the type specified will not be measured, but shall be the square yard final pay quantity in accordance with 109.11 for the area within the limits shown on the plans.

**Basis of Payment**

- 5.1 The accepted quantities of turf establishment of the type specified will be paid for at the Contract unit price per acre or square yard complete in place.
- 5.2 Turf establishment (F) of the type specified are final pay quantity items and will be paid for at the Contract unit price per square yard in accordance with 109.11.
- 5.3 The material cost of crownvetch seed ordered by the Engineer added to slope seed type specified in the plans will be paid for in accordance with 109.04.

**Pay items and units:**

646.3	Turf Establishment with Mulch and Tackifiers	Acre
646.31	Turf Establishment with Mulch and Tackifiers	Square Yard
646.311	Turf Establishment with Mulch and Tackifiers (F)	Acre
646.312	Turf Establishment with Mulch and Tackifiers (F)	Square Yard
646.4	Turf Establishment with Mulch, Tackifiers and Humus	Acre
646.41	Turf Establishment with Mulch, Tackifiers and Humus	Square Yard
646.411	Turf Establishment with Mulch, Tackifiers and Humus (F)	Acre
646.412	Turf Establishment with Mulch, Tackifiers and Humus (F)	Square Yard
646.5	Turf Establishment with Mulch, Tackifiers and Loam	Acre
646.51	Turf Establishment with Mulch, Tackifiers and Loam	Square Yard
646.511	Turf Establishment with Mulch, Tackifiers and Loam (F)	Acre
646.512	Turf Establishment with Mulch, Tackifiers and Loam (F)	Square Yard

**SECTION 646**

**SECTION 647 -- HUMUS**

**Description**

**1.1** This work shall consist of salvaging humus material encountered in the work or furnishing humus material from other sources, and placing the material at the locations shown on the plans or ordered.

**Materials**

**2.1** Humus shall be the surface layer of natural workable soil containing organic matter, or material of a generally humus nature capable of sustaining the growth of vegetation, with no admixtures of refuse or material toxic to plant growth. It shall be free of all viable parts of prohibited invasive plants listed in Table 3800.1 of Part AGR 3800 and relatively free from stones, lumps, stumps or similar objects larger than 2" in greatest diameter, sterile soil, roots, and brush. Ordinary sods of herbaceous growth such as grass and non-noxious weeds will be permitted. Muck, dry enough to be properly measured and spread may be used if it meets the above requirements, but the Engineer reserves the right to prohibit the use of muck which he considers may be or may become a fire hazard. If muck is accepted, extra limestone, sand, or humus material, shall be added as ordered by the Engineer.

**Construction Requirements**

**3.1** The material shall be spread over the properly prepared areas to give a covering which will be approximately 3-1/2" thick, with generally not less than 3" or more than 4", measured normal to the slope.

**Method of Measurement**

**4.1** Humus material will be measured by the cubic yard. Slope measurements will be taken of the lengths and widths of the material in place and the volume will be computed by using the nominal depth of 3-1/2".

**Basis of Payment**

**5.1** The accepted quantity of humus will be paid for at the Contract unit price per cubic yard complete in place.

**5.1.1** Excavation required to undercut slopes in order to accommodate the material will be subsidiary.

**Pay item and unit:**

647.1	Humus	Cubic Yard
-------	-------	------------



**SECTION 648 -- SOD****Description**

**1.1** This work shall consist of furnishing and placing live grass sod, including sod gutters, as shown on the plans or ordered. This work shall also include any excavation necessary to place the sod.

**Materials**

**2.1** Sod shall consist of an approved, dense, vigorous, well-rooted growth of commercial turf of perennial grasses indigenous to the area where it is to be used.

**2.1.1** The sod shall be free from viable parts of prohibited invasive plants listed in Table 3800.1 of Part AGR 3800, noxious weeds, annual grasses, large stones or roots, or other materials harmful to growth, or which would interfere with mowing or future maintenance.

**2.1.2** The soil shall be of such character that the sod will not break or crumble.

**2.2** Pegs for holding shall be of sound wood approximately 3/4" square or round, and 8 to 10" long.

**Construction Requirements**

**3.1 Sodding seasons.** Unless otherwise permitted, sodding shall be done between April 1 and June 1, or between August 15 and October 15, but not when the ground or sod is frozen.

**3.2 Cutting sod.** The sod shall be cut with an approved sod cutter into strips of uniform width having minimum dimensions of 12 by 18" The sod shall be severed below the root line, shall have a uniform thickness and shall contain the majority of the feeding roots of grasses.

**3.3 Site Preparation.**

**3.3.1** Areas to be sodded shall be brought to grade with 4" of loam as shown or ordered, making allowance for the thickness of the sod.

**3.3.2** As necessary, the soil shall be harrowed, tilled, or otherwise loosened to a depth of at least 2" to allow for mixing of the soil with the fertilizer and limestone.

**3.3.3** The area shall be cleaned of large stones, roots, or other debris which might interfere with laying of the sod.

**3.4 Laying Sod.**

**3.4.1** Sod shall be in a moist condition when laid and shall be placed on a reasonably moist bed. The sod shall be carefully placed and tightly fitted edge to edge. Any broken, damaged, or irregular shaped sod will be rejected.

**3.4.2** On slopes, the sod shall be laid at right angles to the slope, beginning at the bottom.

**3.4.3** Transverse joints shall be staggered, and any unavoidable gaps shall be filled with sod plugs or loam.

**3.4.4** All sod shall be tamped with an approved tamper or roller to ensure tight joints and a smooth uniform surface.

**3.4.5** The inlet edges of sod in waterways and other edges exposed to water scour shall be turned down and buried to a depth of 3" with tamped earth.

**3.4.6** On slopes steeper than 4:1, every other line of sod shall be fastened with wooden pegs spaced 3 ft. apart and driven flush with the surface of the sod.

**3.4.7** Single lines of sod for anchoring loam on slopes greater than 4:1 shall be secured as 3.4.6.

**3.4.8** After laying, all sod shall be thoroughly watered immediately after rolling, and in the absence of rain repeat every day until the roots have grown into the soil. (Normally rooting requires two to three weeks.)

## SECTION 648

### Method of Measurement

4.1 Sod will be measured along the slope, except that the width of gutters will be as shown on the plans or ordered. Dead sod will not be measured. Sod will be computed to the square yard.

### Basis of Payment

5.1 The accepted quantity of sod will be paid for at the Contract unit price per square yard complete in place.

5.2 Excavation required to complete this work will be considered as incidental to the items, but fertilizer, limestone, and loam ordered will be paid for under the respective Items.

#### Pay item and unit:

648.	Sod	Square Yard
------	-----	-------------

**SECTION 650 -- PLANTING - GENERAL****Description**

**1.1** This specification includes general requirements that are applicable to all types of planting, including trees, shrubs, vines and ground cover plants, irrespective of type. Deviations from these general requirements will be indicated in the specific requirements for each type.

**1.2** This work also includes furnishing and installing landscaping materials, including all layout, fertilizing, soil conditioning, staking, guying, watering, excavating, weeding, herbicides, fungicides, pesticides, refertilizing as necessary, replanting as needed, and stake and guy removal after the establishment period, as shown on the plans or as ordered.

**Materials****2.1 Plants.****2.1.1 General.**

**2.1.1.1** Plant material shall meet the current specifications of the “ American Standard for Nursery Stock” as published by the American Association of Nurserymen unless otherwise specified.

**2.1.1.2** All plants shall be first class and shall be representative of their normal species or varieties. All plants must have a good, healthy, well-formed upper growth and a large, fibrous, compact root system.

**2.1.1.3** All plants shall be nursery grown stock that has been transplanted unless indicated as “ seedlings”, or root pruned at least once every 4 years. Plant hardiness shall be determined acceptable by the Engineer as specified relative to the zone of origin. A sworn affidavit as to region of growth shall be furnished when ordered.

**2.1.1.4** Unless otherwise specified, so-called exposed or “ bare-root” material will be accepted. Container grown plants may be furnished in lieu of balled and burlapped plants, provided they meet the current specifications in the American Standard for Nursery Stock.

**2.1.1.5** Any non-bid substitution of plant material shall be acceptable only if the bid item(s) is unavailable. Requests for plant substitutions and proof of unavailability shall be furnished to the Engineer in writing one month prior to the beginning of the planting season.

**2.1.2 Names and Marking.**

**2.1.2.1** All scientific and common plant names of the items specified shall conform with the current edition of “ Hortus Third” compiled by the staff of the L. H. Bailey Hortorium, Cornell University. All plants delivered shall be true to name.

**2.1.2.2** Each bundle, or each plant, when not tied in bundles, shall be legibly and properly labeled. Care shall be taken throughout the operation to keep each plant species or variety segregated and labeled. The Engineer may reject at any time any plant material of questionable nomenclature.

**2.1.3 Inspection.**

**2.1.3.1** All plants shall be free from plant diseases and insect pests, and shall comply with all applicable State and Federal laws with respect to inspection for plant diseases and infestations.

**2.1.3.2** Plant material may be inspected in the nursery or collecting fields before it is dug. The Contractor shall provide a list of suppliers in sufficient time so the Engineer may inspect nurseries on a timely bases. Approval to move nursery material to the project site shall not be considered as Acceptance. The Contractor shall notify the Engineer not less than 48 hours in advance of delivery of plants.

**2.1.3.3** All planting stock shall conform to the laws of New Hampshire and shall be inspected before removal from the nursery, by authorized Federal, State or other authorities as may be required in the area where the nursery is located. The invoice or order for each shipment of plants shall contain the project name and number and the quantity and variety of plant material delivered. An inspection certificate shall certify that the plants are free of disease and insect pests of all kinds and shall accompany each shipment. Disease certificates and delivery slips shall be given to the Engineer upon arrival of the plant material at the point of delivery.

**2.1.3.4** For purchase of material from nurseries within New Hampshire, information regarding inspection for plant disease and pest infestations is available from the New Hampshire Department of Agriculture. Inspection of plants from outside New Hampshire is controlled by the United States Department of Agriculture and information is available from the United States Department of Agriculture, Animal & Plant Health Inspection Service.

## SECTION 650

### 2.1.4 Digging, Handling, and Packing.

**2.1.4.1 General.** Plants shall be dug with care and skill. Special precautions shall be taken to avoid any unnecessary injury to, or removal of fibrous roots from the plants. Each species or variety shall be handled and packed in the approved manner for that particular plant. All precautions shall be taken to ensure the arrival of the plants at the project site in good condition for successful growth.

**2.1.4.2 Balled and burlapped plants.** The ball shall be firm and, unless a manufactured ball is allowed, shall be composed of the original and undisturbed soil in which the plant has been grown. The plant shall be handled in such a manner that the soil in the ball will not drop away from the roots and will not cause stripping of the small, fine-feeding roots. The ball shall be wrapped with burlap or other approved material and tightly laced to hold the desired shape. Plastic ball wrap material shall not be allowed. No balled plants will be accepted if the ball is cracked or broken. A substitute for burlap may be approved provided it can be demonstrated that the material is tight enough to retain the soil ball securely. During planting operations material which will not readily disintegrate in the ground shall be removed or extensively cut to allow the roots to grow through freely.

**2.1.4.3 Bare-root plants.** The roots of bare-rooted stock shall be carefully packed in sphagnum moss, moist straw, or other suitable material that will ensure the arrival of plants in an acceptable condition.

### 2.1.5 Shipment.

**2.1.5.1** Arrangements shall be made as far as practicable to have plants delivered as the planting pits or beds are ready for them.

**2.1.5.2** Plants which have heated or sweated at any time, or have been broken, fractured, scraped, or bruised, will be rejected.

**2.1.5.3** All local, state, or federal laws relative to the shipping of plants shall be strictly complied with.

### 2.1.6 Measurement.

**2.1.6.1** Measurement will be made in accordance with the practice prescribed in the current edition of the “ American Standard for Nursery Stock” published by the American Association of Nurserymen.

2.2 Blank.

2.3 Blank.

2.4 Layout marking material shall be clean 1” x 1” x 4 ft. high hardwood lumber stakes, wire type flagging, 1” minimum width plastic flagging or other approved material.

2.5 Plant support materials shall conform to the following unless otherwise specified.

**2.5.1** Vertical stakes shall be hardwood lumber stakes or posts 2” x 2” minimum square or 1-1/2” diameter minimum round of the length required as shown on the plans. Hub stakes shall be 2” x 2” x 30” minimum square hardwood lumber.

**2.5.2** Guy material for vertically staked trees shall be double strand 3/32” minimum diameter galvanized wire with wide, smooth and flexible approved tree guying material.

**2.5.3** Guy material for hub staked trees shall be 3/16” minimum diameter galvanized wire with hose sleeves.

2.6 Rodenticides, herbicides, and pesticides shall be those approved for use by the New Hampshire Pesticide Control Board.

2.7 Water used in the planting or care of vegetation shall be free from any substance injurious to plant life.

2.8 Antidesiccant shall be of an approved emulsion which will provide a film over plant surfaces, permeable enough to permit the exchange of gases but inhibit the passage of water vapor.

### 2.9 Fertilizer.

**2.9.1** Fertilizer shall be a standard commercial grade fertilizer conforming to all State and Federal regulations and to the standards of the Association of Official Agricultural Chemists. The analysis shall represent respective percentages of nitrogen, phosphoric acid, and potash.

**2.9.1.1** All fertilizer shall be identified by labels and shall show the following:

- (a) Guaranteed analysis.
- (b) Name and address of the guarantor of the fertilizer.
- (c) Type or brand.
- (d) Net weight.

**2.9.1.2** Dry fertilizer for other than acid-loving plants shall have an analysis of 10-6-4 (preferred), 10-3-6, or 10-5-5, or with written permission, a substitute may be furnished. In any case, a minimum of 50 percent of the nitrogen shall be water-insoluble (50 percent WIN).

**2.9.1.3** Water-soluble fertilizer shall be completely water soluble. Fertilizer for other than acid-loving plants shall contain the following minimum percentages of available elements by weight: nitrogen, 16 percent, phosphoric acid, 19 percent, potash, 16 percent. The total available nutrients shall be at least 55 percent by weight.

**2.9.1.4** Fertilizer for acid-loving plants shall be formulated for acid-loving plants such as rhododendrons, azaleas, and blueberries. Dry fertilizer for such plants shall have a minimum analysis of 7-7-7 or as approved. Water-soluble fertilizer for such plants shall have an analysis in the range of 21-7-7 or as approved.

## **2.10 Soil Conditioners.**

**2.10.1** Peat moss shall be air-dried, granulated, sphagnum peat moss, nearly free from woody substances, consisting of at least 75 percent of partially decomposed stems and leaves of sphagnum, and essentially brown in color. The texture may vary from porous fibrous to spongy fibrous and shall be free of sticks, stones, and mineral matter. Peat moss shall not show an acid reaction of less than 3.5 pH.

**2.10.2** Peat humus shall be natural peat or peat humus from fresh water saturated areas, consisting of sedge, sphagnum, or reed peat, and shall be of such physical condition that it will pass through a 1/2" mesh screen. The humus shall be free from sticks, stones, roots, and other objectionable materials. Samples taken at the source of supply shall meet the following requirements:

Acidity:	not less than 4.0 pH.
Minimum water absorbing ability:	200 percent by weight on oven-dry basis.
Minimum organic content:	60 percent when dried at 221 °F.

**2.10.2.1** Freshly excavated peat, if saturated with water, shall be stored for a sufficient length of time to condition it for workability.

**2.10.3** Humus material other than peat humus shall conform to 647.2.

## **2.11 Mulches.**

**2.11.1** Wood chips shall be obtained primarily from disease-free green hardwood, shall be 1/4" in nominal thickness, and 50 percent shall have an area of not less than 1 sq. in. nor more than 6 sq. in. Not more than 2 percent shall consist of leaves, twigs, or shavings, and it shall be free of materials injurious to plant growth. Wood chip mulch must be approved prior to use. Where wood chips are specified, bark may only be used when permitted.

**2.11.2** Bark mulch shall be bark chippings graded to be approximately 3/8 to 2" in width. The chippings shall not have been stored so long and under such conditions that the material has decomposed sufficiently so that it has lost its fibrous texture. Bark mulch must be approved as to grading and condition prior to its use. Where bark mulch is specified, wood chips may only be used when permitted.

**2.11.3** Other mulch material may be used upon approval.

## **2.12 Loam Backfill.**

**2.12.1** Loam backfill, when existing soils are not acceptable, shall be relatively free of roots or rhizomes of witchgrass. No sticks, sods, clods or other material which would tend to form large air pockets in the soil shall be included. The use of muck will not be permitted around any plantings.

**2.12.2** Loam backfill shall have minimum and maximum pH values of 6.0 and 7.6, respectively. Organic matter, as determined by loss by ignition, shall be from 6 percent to 20 percent. Natural topsoil with a pH over 4.5 and over 4 percent organic may be amended to meet these specifications.

**2.12.3** A loam source will be sampled and tested by the Engineer so that the results are obtained at least three days prior to planting and prior to the addition of soil amendments. Planting shall not begin prior to loam approval.

**2.12.4** After the test results are known, amendments shall be made, when necessary to meet the minimum pH and organic standards.

**2.12.5** To each cubic yard of accepted loam, the following shall be added and thoroughly mixed to produce loam backfill: 2 to 3 cubic feet of well-rotted cow manure (dehydrated cow manure at a rate specified by the Engineer); 4 cubic feet of sphagnum peat moss; 15 lb. of 10-6-4 fertilizer minimum 50 percent water insoluble (WIN); and 20 lb. of ground agricultural limestone.

## SECTION 650

**2.12.5.1** When permitted, compost or individual components of the loam backfill may be added directly to the approved plant pits.

**2.12.5.2** Batch size for mixing shall be determined by the Engineer, typically 15 cubic yards.

### Construction Requirements

#### 3.1 Planting Seasons.

**3.1.1** Unless otherwise directed, seasons for planting shall be within the following dates:

Deciduous/Evergreen Material:	Spring - April 1 to June 30
	Fall - August 15 to November 15

**3.1.2** Preparations for planting may begin earlier than the specified season, and if approved, planting work may continue beyond the specified time limits. Permission to extend planting dates shall be requested in writing to the Engineer at least 10 working days before the end of the planting season. The request shall include a legitimate reason for the extension. Any anticipated shortages of plant material shall be brought to the attention of the Engineer upon discovery.

However, the Engineer may require that all plants planted out of season, except deciduous material planted prior to April 1 and after November 15, shall be balled, burlapped, and dead or damaged branches removed.

**3.1.3** No planting shall be done when the site or weather is unsatisfactory for planting, unless permitted.

#### 3.2 Delivery and Inspection.

**3.2.1** A preliminary check will be made of all plants at the time of delivery for condition of the plants and general conformity to the specifications. A more thorough inspection of individual plants will be made just prior to planting. No plants shall be planted which have not received this inspection. In order to facilitate this inspection, the Contractor shall inform the Engineer, at least 24 hours in advance, as to what plants are to be planted and in what location. Any plants planted without receiving this inspection will be rejected and if rejected must be removed and replaced with inspected stock.

**3.2.2** Due to the difficulty of identifying dormant plants and to the effect of handling on the health and vigor of plants, only conditional approval will be given to plants in preliminary and intermediate inspections. Inspection will continue throughout the life of the Contract up to the time of Acceptance. Plants discovered at any time which are not true to name, do not conform to the specifications, show evidence of improper handling or lack of proper care, or which appear to be in a seriously unhealthy condition for any other reason must be removed from the project site at once and replaced by acceptable plants as soon as the planting season allows.

**3.2.2.1** Subject to approval of the Engineer, plants which show minor infestations of insects or disease appearing after planting may be treated in lieu of being replaced.

**3.2.3** At least 3 working days before digging any collected or plantation-grown material, the Contractor shall notify the Engineer of the time and place of digging so that inspection of the work and of the material may be made by the Engineer.

#### 3.3 Protection and Temporary Storage.

**3.3.1** The Contractor shall keep all plant material moist and protected from drying out. Protection shall be provided during the time the plants are in transit, in temporary storage, or on the project site awaiting planting.

**3.3.2** Unless otherwise approved by the Engineer, plants delivered, but not scheduled for immediate planting, shall be protected as follows:

- (a) Bare-root plants shall be heeled-in in moist soil in a satisfactory manner. All plants heeled-in shall be properly maintained by the Contractor until planted.
- (b) Balled and burlapped plants shall have the earth balls covered with wood chips or other suitable material and shall be kept in a moist condition.

**3.3.3** The Contractor shall exercise the utmost care in loading, unloading, or handling of plants to prevent injuries to the branches or to the roots of the plants. The solidity of balled and burlapped plants shall be carefully preserved.

**3.3.4** While plants with exposed roots are being transported to and from heeled-in beds, or are being distributed in planting beds, or are awaiting planting after distribution, the Contractor shall protect the roots from drying out by means of wet canvas, burlap, or straw, and watering, if necessary. The means employed shall be satisfactory and shall depend on weather conditions and the length of time the roots must remain out of the ground.

### 3.4 Layout.

**3.4.1** The Engineer may adjust plant material locations to meet field conditions. Project plant material locations and bed outlines shall be delineated (flagged, marked, staked, etc.) on site by the Contractor, per the plan, for review and approval by the Engineer. Plant locations may be adjusted by the Engineer to meet local site conditions. All layout marking material required shall be furnished by the Contractor.

**3.4.2** Ten working days prior to the start of planting work on the project, the Contractor shall provide a planting schedule to be used in establishing priorities in laying out plant locations. The Contractor shall give at least 2 working days' notice of any deviations from this schedule. The Engineer will not be responsible for any delays or inconvenience resulting from the Contractor's failure to follow the above procedure.

**3.4.3** An artificial appearance in the layout scheme is generally not desired. Except where uniform spacing may be required, as in the case of snow-control planting and the like, some variation in spacing is essential and care must be taken to avoid straight lines and uniform spacing unless directed otherwise.

### 3.5 Excavation.

**3.5.1** Excavation for plant pits shall not begin before the approved loam backfill is available on the project.

**3.5.2** Holes for plant material shall be excavated at the indicated locations and shall be a minimum width or 2 times the root ball diameter. The width of planting pit shall be double that of the root system or ball. Plant pit requirements are shown on the planting detail sheet.

**3.5.2.1** Trenching may be ordered for special sites such as long narrow medians. Trenches shall be the same depth of the root ball/potted container. The width of the trench shall be double of the root system or ball.

**3.5.3** Surplus excavated material or material unsuitable for backfill or saucer construction shall be removed from the site as soon as practicable or disposed of as ordered.

**3.5.4** When rock or boulders over 1/3 cubic yard in size are encountered in digging plant pits, the Contractor shall notify the Engineer, who will change the location of the plants. No excavation of rock or boulders over 1/3 cubic yard in volume will be required.

**3.5.5** If topsoil on the planting site is acceptable as loam, the topsoil encountered in the excavation may be used for loam backfill when it is kept separate from the subsoil. Soil amendments may be required. See 2.12.4.

**3.5.6** In certain areas of poor drainage or heavy soil, the Engineer may require that the soil excavated from the plant pit be spread on the ground adjacent to the pit and neatly distributed so as to raise the grade of the area to provide better surface drainage. Where shown on the plans or directed, such pits may also require ditches. When ditches are required, they shall be included as a part of the cost of the plant. Beds constructed by trench method must be raised sufficiently to permit drainage to flow alongside and not into the bed.

**3.5.7** Where permitted, bare-root evergreens such as seedlings or transplants may be planted in the existing soil. Plant holes must be deep enough to allow room for the full depth of the root without doubling, folding, or pruning, and wide enough to allow room for its normal spread. Plants must be set straight and at the same depth at which they were previously growing. Soil must be firmly compacted around the roots, leaving no air pockets. In heavy grass the Engineer may require that the sod be removed or folded back to a distance of 4 to 6" from the main stem of each plant, or require herbicide treatment in advance of planting.

### 3.6 Setting Plants.

#### 3.6.1 General.

**3.6.1.1** Plants shall be set to depths appropriate to the various types of material, local drainage, and the special requirements of each. In general, plants shall be placed on undisturbed soil so that the root crown is even with or slightly higher than the ground level. Roses and budded or grafted plants shall be set at least 3" below their previous earth line or as directed.

**3.6.1.2** All trees and shrubs shall be planted plumb.

**3.6.1.3** As shown on the planting detail sheets, the ground around the plants shall be graded and rims shall be constructed at the edge of the plant pit for each plant, forming a saucer capable of holding sufficient water to give the root system a good soaking. Saucer rims shall be tamped so as to be durable enough to allow several years of watering if necessary. To prevent the growth of weeds and noxious grasses, the rims shall be constructed from soil removed from the plant pits. Imported loam for backfill shall not be used in the construction of the plant saucer rims and every effort shall be made to prevent spillage of loam in the planting area.

**3.6.1.3.1** Saucers shall be inspected and approved by the Engineer prior to placement of mulch.

## SECTION 650

### 3.6.2 Planting and Backfilling Bare-Root Plants.

3.6.2.1 Prepared backfill soil shall be placed in the plant pit to the required minimum depth and very slightly tamped. Plants shall then be placed in the center of the pit and roots properly spread out in a natural position. All broken or damaged roots shall be cleanly cut back to healthy root growth.

3.6.2.2 Backfill soil shall then be carefully worked around and over the roots, with thorough watering. Care shall be taken to avoid the bruising or breaking of roots.

### 3.6.3 Planting and Backfilling Balled and Burlapped Plants.

3.6.3.1 Plants of this type shall be handled and placed in holes in such a manner that the soil of the ball will not be loosened. After the hole has been partly backfilled and the soil watered under and around the ball, the burlap and ties at the top of the root ball shall be cut away and removed to avoid girdling, and the remaining burlap slit on the sides and adjusted to prevent the formation of air pockets and the basket cut and loosened. Backfilling and watering shall then be completed in a manner to avoid loosening the soil of the root ball.

### 3.6.4 Planting and Backfilling Potted Plants.

3.6.4.1 All containers shall be carefully removed prior to planting. Pot-bound material shall be subject to rejection if proper root pruning cannot be accomplished in a manner acceptable to the Engineer.

## 3.7 Fertilizing.

3.7.1 Initial fertilization shall consist of the use of dry fertilizer, water-soluble fertilizer, or a combination of both as permitted.

3.7.1.1 Dry fertilizer, when not included in the loam backfill, including fertilizer for acid-loving plants as appropriate, shall be uniformly mixed with the loam used as backfill about the plants at the following rates:

- (a) Trees: 1-1/2 lb. /in. of caliper.
- (b) Shrubs: 1/4 lb./ft. of height.
- (c) Vines: 1/2 lb. per vine.

3.7.1.2 Water-soluble fertilizer, when ordered by the Engineer, including fertilizer for acid-loving plants as appropriate, shall be dissolved in water at the rate recommended by the manufacturer. The thoroughly mixed solution shall be applied at the time of initial planting after the water used for backfill soaking has leached away. Care shall be taken to prevent washing plant saucers away either during the original watering or while applying water-soluble fertilizer.

3.7.1.2.1 The fertilizer solution shall be applied at the following rates:

- (a) Seedling plants, except coniferous: 1 pint per plant.
- (b) Plants up to 2 ft. in height shall receive 4 quarts.
- (c) Plants over 2 ft. and up to 6 ft. shall receive 6 quarts.
- (d) Plants over 6 ft. and up to 12 ft. shall receive 12 quarts.
- (e) Plants over 12 ft. shall receive 16 quarts.

### 3.7.2 Refertilization.

3.7.2.1 Unless otherwise ordered, up to two refertilizations shall be done using a water-soluble fertilizer applied in conjunction with watering or by itself. No refertilization will be allowed between August 1 and plant dormancy and between frozen ground and April 1.

3.7.2.2 All plants except seedlings and root plantings shall be fertilized at least once between April 1 and August 1 with water-soluble fertilizer mixed and applied in accordance with 3.7.1.2 or as directed when applied with a watering. Dry fertilizer for acid-loving plants may be used for such plants provided it is dissolved in sufficient water to make a workable solution and the solution is applied around the outside drip line of the branches at the rate of 1/4 lb/ft. of height of shrub.

3.7.2.3 When the Contract period extends spring to spring, all plants except seedlings and root cuttings shall receive an additional application of fertilizer in the spring prior to Acceptance.

## 3.8 Watering.

3.8.1 Watering equipment shall be on the project prior to planting and shall be available at any time during the life of the project. This equipment shall provide enough water to thoroughly soak the plant material root systems for the entire project within 48 hours. Watering equipment shall be equipped with a regulating device on the end of the hose to provide the operator with the ability to control the flow and pressure of water. Plants shall be watered immediately following planting, preferably when two-thirds of the backfill has been placed so all air pockets are removed and the plant properly set. Then a later watering to thoroughly soak the root system shall be performed within 24 hours of planting. Thereafter, watering shall be done every week throughout the growing season unless otherwise directed.



### 3.9 Guying and Staking.

**3.9.1** When required or ordered by the Engineer all trees shall be staked and guyed in a taut manner in accordance with the details shown on the plans as soon as the plant is in place. Guy material shall be loosely secured to the tree to provide for growth of the trunk and allow approximately 1" sway in the tree. Hub stakes shall not protrude more than 8" above the ground.

**3.9.2** All stakes and guys shall be removed after the establishment period unless otherwise directed.

### 3.10 Antidesiccant Spray.

**3.10.1** Antidesiccant spray shall be used when directed.

### 3.11 Pruning.

**3.11.1** Pruning of dead or damaged branches shall be done preferably before or immediately after planting in such a manner as to preserve the natural character of each plant. All pruning shall be done by experienced personnel with properly conditioned equipment and in keeping with accepted horticultural practice.

### 3.12 Mulching.

**3.12.1** Within 48 hours of planting a plant, unless a longer period is allowed, mulch material shall be furnished and placed over all pit or saucer areas of individual trees, shrubs, and vines, and over the entire area of shrub beds to the depth indicated on the plans. Mulch material shall either be bark mulch or wood chips. Saucers shall be inspected prior to placement of mulch or chips.

### 3.13 Restoration and Cleanup.

**3.13.1** Where existing grass areas have been damaged or scarred during planting operations, the disturbed areas shall be restored to their original conditions as directed at no additional cost to the Department. Mowing may be required when directed by the Engineer to ensure complete slope restoration. All debris, spoil piles, containers and the like shall be cleaned up and the project left in an acceptable condition after each planting season. All slopes shall be left in a smooth condition with ruts and excavated soils removed and areas regraded as required.

### 3.14 Establishment Period.

**3.14.1** The acceptability of the plant material furnished and planted as specified will be determined at the end of the establishment period. The period of establishment shall begin as soon as all plants are planted and shall extend for 1 year or until the date of Acceptance, whichever date is later. During this period, the Contractor shall continuously monitor the condition and general health of the plantings and initiate all horticultural practices necessary to maintain plants in a healthy condition including watering, fertilization, weeding, pesticide application, rodent control, pruning, repairing saucers, adding mulch, adjusting guys and stakes, and replacement of unacceptable plants, together with such other work as may be ordered. At the end of the establishment period, all guys, stakes, and hubs shall be removed, unless otherwise directed.

**3.14.1.1** Weeding shall be a minimum of 1 ft. beyond the limit of the saucers. Planting beds shall be weeded in their entirety.

**3.14.2** An inspection will be made by the Contractor and the Engineer immediately prior to or early in the planting season following the original planting season to determine the condition of the plant material. Dead plants, diseased plants, plants lacking sufficient vigor, or plants showing evidence of sizable die-back shall be replaced. Unacceptable plant material must be removed promptly from the project.

**3.14.3** The Engineer may require that replacement plants that are not dormant or that are planted late in the planting season shall be sprayed as directed with an approved Antidesiccant.

**3.14.4** Except as provided in 2.1.1.5, all replacement plantings shall be of the same kind and size as originally specified. The use of more loam and more initial fertilizer may be waived by the Engineer; otherwise, replacement plantings shall be handled, planted, and maintained in the same manner specified for the original plantings.

### 3.15 Herbicides, Insecticides, and Fungicides.

**3.15.1** The Engineer may order, or the Contractor may request, the use of an approved herbicide at planting locations when it is determined that the chemical control of weeds is necessary.

**3.15.2** The Engineer may order, or the Contractor may request, the use of a suitable insecticide or fungicide when it is determined that infestations of insects or plant disease require the use of such material.

**3.15.3** All herbicides, insecticides, and fungicides shall be applied as prescribed by their manufacturer and in accordance with New Hampshire laws. The Contractor shall either possess from the New Hampshire Pesticide Control Board the proper registrations and permits for the application of such materials or have the applications made by an approved, qualified firm holding

## SECTION 650

such registrations and permits. Copies of all permits in connection with such materials shall be furnished to the Engineer. All pesticide application within the right-of-way or project limits will require a special permit from the New Hampshire Department of Agriculture, Division of Pesticide Control.

### 3.16 Protection Against Rodents.

**3.16.1** Rodent protection is a required part of plant care during the life of the Contract. An approved rodenticide shall be used on all plants that are susceptible to rodent damage. Approval for the proposed rodenticide and for the method of application must be obtained from the New Hampshire Department of Agriculture, Division of Pesticide Control and copies of the approval shall be furnished to the Engineer. A mixture of wood alcohol and rosin may be used in the absence of an approved rodenticide.

#### Method of Measurement

**4.1** Plant material will be measured by the number of units of plants in healthy condition, of the specified sizes and species, furnished and planted.

**4.2** Landscaping will be measured as a unit. A unit will include furnishing and installing landscaping materials, including all layout, fertilizing, soil conditioning, staking, guying, watering, excavating, weeding, herbicides, fungicides, pesticides, refertilizing as necessary, replanting as needed, and stake and guy removal after the establishment period, as shown on the plans or as ordered.

#### Basis of Payment

**5.1** All work performed will be paid for as provided under the appropriate Sections 651 through 659.

**5.2** When substitutions are approved, payment will be by supplementary agreement.

**5.2.1** Any non-bid substitution of collected stock as described in 2.1.1.5 will be subject to a price reduction of 25%.

**5.3** Excessive damage due to heavy insect infestations, if all reasonable precautions are taken by the Contractor, will be reason for consideration of extra payment for approved replacements.

**5.4** The accepted quantity of landscaping unit will be paid for at the Contract lump sum price complete in place.

**5.4.1** The Contractor shall submit a "Bill of Materials" for approval in accordance with 105.02 at least three weeks prior to starting the landscaping item. The "Bill of Materials" shall include a unit price breakdown of planting materials. Once approved, this list will be used as a basis to adjust the landscaping item if substitution of plant material is required.

**5.4.1.1** Anticipated shortages in any particular plant material shall be brought to the attention of the Engineer and Roadside Development Section. Upon such discovery, the Contractor shall promptly request plant material substitution in writing. The request shall include at least ten (10) Certified Nursery sources that were contacted for confirmation. The Contractor shall also submit the price of the proposed substitute material.

**5.4.1.2** Upon approval of the substitute plant material, the Engineer will adjust the unit price, either increase or decrease, by multiplying the number of substituted plants by the difference between the base plant price and the substituted plant price. The result will then be divided by the unit price to come up with the new adjusted unit.

#### Pay Items and Units:

650.2	Landscaping	Unit
-------	-------------	------



**SECTIONS 652 & 653**

***SECTIONS 652 AND 653 -- DECIDUOUS TREES***

**Description**

**1.1** This work shall consist of furnishing and planting deciduous trees of the specified size and type at the locations shown or as ordered.

**Materials**

**2.1** Materials shall conform to the requirements of 650.2.

**Construction Requirements**

**3.1** Construction requirements shall be as prescribed in 650.3.

**Method of Measurement**

**4.1** Deciduous trees will be measured as prescribed in 650.4.

**Basis of Payment**

**5.1** The accepted quantities of deciduous trees will be paid for at the Contract unit price per each for trees of the specified sizes and species complete in place.

**Pay items and units:**

652. (a) (Specific Deciduous Tree) Each

653. (a) (Specific Deciduous Tree) Each

(a) These pay item numbers have been assigned to this section in order to accommodate the many varieties of deciduous trees on the landscape list used by the Department.

**SECTION 654 -- EVERGREEN SHRUBS**

**(Needle and Broadleaf)**

**Description**

1.1 This work shall consist of furnishing and planting evergreen shrubs (needle and broadleaf) of the specified size and type at the locations shown or as ordered.

**Materials**

2.1 Materials shall conform to the requirements of 650.2.

**Construction Requirements**

3.1 Construction requirements shall be as prescribed in 650.3 and when directed, shrubs shall be guyed in the same manner as trees, as prescribed in 650.3.9.1.

**Method of Measurement**

4.1 Evergreen shrubs will be measured as prescribed in 650.4.

**Basis of Payment**

5.1 The accepted quantities of evergreen shrubs will be paid for at the Contract unit price per each for shrubs of the specified sizes and species complete in place.

**Pay item and unit:**

654. __	(Specific Evergreen Shrub)	Each
---------	----------------------------	------

**SECTIONS 655 AND 656 -- DECIDUOUS SHRUBS**

**Description**

1.1 This work shall consist of furnishing and planting deciduous shrubs of the specified size and type at the locations shown or as ordered.

**Materials**

2.1 Materials shall conform to the requirements of 650.2 as amended below.

2.2 Sweetfern sods shall be 12 by 12" sods, 2-1/2 to 3" thick. All sods shall have 3 or more woody stems of native sweetfern plants with original natural soil surrounding the roots. Sods shall be free from noxious weeds.

2.3 When the plans call for smooth and staghorn sumac, collected, the plants furnished shall be a mixture of approximately 40 percent of the smooth variety and 60 percent of the staghorn variety unless otherwise permitted.

2.3.1 Sumac plants shall be at least 2 years old. The minimum allowable caliper of the stem shall be 1/4", measured at least 6" above the ground. Plants higher than 5 ft. shall not be collected. The main roots (rhizomes) shall be at least 6" long each side of the stem. The top may be pruned prior to or after planting, provided the remaining plant is not less than 18" high.

**Construction Requirements**

3.1 Construction requirements shall be as prescribed in Section 650.3 as amended below.

3.2 Deciduous shrubs shall be pruned in the same manner as specified for trees in accordance with 650.3.11, except that sumac shrubs shall not be pruned in the fall.

**3.3 Sweetfern.**

3.3.1 Collection of sweetfern may be made during the dormant season, but not later than May 1 except by permission. Planting of the item may start as early in the spring as the ground may be worked and shall be completed no later than June 1 except by permission. Protection from dehydration during collecting, storing, and planting shall be as described under 650.3.3.

3.3.2 The roots of sweetfern plants, unless otherwise ordered, shall be planted horizontally in freshly prepared (moist) pits at a depth of 4 to 6", at the spacing shown on the plans. The stem section of the crowns shall be cut back to approximately 2 to 3" above the ground or so that it will appear approximately 1" above the mulch or as directed. Before the ground around the planting has had time to dry out, an application of hay mulch shall be applied at the rate of 3 to 4 tons per acre or as ordered.

3.3.3 No fertilizer will be required with planting of sweetfern.

3.3.4 When sweetfern sods are required, sods shall not be stored in such a manner as to compress the thickness of the sod below the minimum 2-1/2" specified. Generally, storage will not be permitted for longer than 5 days. Sods which have been stored beyond this time limit and sods which have become dried out or broken prior to placement in final position may be rejected.

3.3.4.1 Sods shall be firmly incorporated into the soil at the designated spacing. Hay mulch shall be required as specified in 3.3.2. The Contractor shall take all necessary precautions in maintaining a healthy sod from the date of actual planting until Acceptance.

**3.4 Sumac.**

3.4.1 Sumac plants may be collected until May 25.

3.4.2 The plant pit shall be dug large enough to easily accommodate the root system with 1/3 ft<sup>3</sup> extra on the bottom. At least 1/3 ft<sup>3</sup>, approximately 12 quarts of loam well mixed with 1/2 lb. of dehydrated cow manure shall be added before the plants are placed in the pit.

**Method of Measurement**

4.1 Deciduous shrubs will be measured as prescribed in Section 650.4.

4.2 Sweetfern sods will be measured per each 12 by 12" sod.

**Basis of Payment**

**5.1** The accepted quantities of deciduous shrubs will be paid for at the Contract unit price per each for shrubs of the specified sizes and species complete in place.

**5.1.1** Hay mulch used in connection with sweetfern will be subsidiary.

**Pay items and units:**

655. (a) (Specific Deciduous Shrub) Each

656. (a) (Specific Deciduous Shrub) Each

(a) These pay item numbers have been assigned to this section in order to accommodate the many varieties of deciduous shrubs on the landscape list used by the Department.

**SECTION 657**

***SECTION 657 -- VINES AND GROUND COVERS***

**Description**

**1.1** This work shall consist of furnishing and planting vines and ground covers of the specified size and type at the locations shown or as ordered.

**Material**

**2.1** Materials shall conform to 650.2.

**Construction Requirements**

**3.1** Construction requirements shall be as prescribed in 650.3.

**Method of Measurement**

**4.1** Vines and ground covers will be measured as prescribed in 650.4.

**Basis of Payment**

**5.1** The accepted quantities of vines and ground cover will be paid for at the Contract unit price per each for vines or ground cover of the specified sizes and species complete in place.

**Pay item and unit:**

657._	(Specific Vine or Ground Cover)	Each
-------	---------------------------------	------



**SECTION 658 -- TRANSPLANTING PLANT MATERIAL**

**Description**

1.1 This work shall consist of digging up plant material consisting of trees, shrubs, and vines, and transplanting such at the locations shown or ordered. If temporary storage is necessary, care shall be taken to heel-in or plant the material where it can receive proper care until the permanent site is ready.

**Materials**

2.1 Materials shall conform to the requirements of 650.2, except that the plant material shall consist of the existing plants designated.

2.1.1 Where plant materials are designated to be moved and insufficient root systems or other faults are found in the existing plants, the Engineer may direct that new plants from nursery stock of similar or approved species be substituted.

**Construction Requirements**

3.1 Construction requirements shall conform to the applicable construction requirements of 650 through 657 for the type of plant material being transplanted.

**Method of Measurement**

4.1 Transplanting plant material will be measured as prescribed in 650.4.

**Basis of Payment**

5.1 The accepted quantities of plant material transplanted will be paid for at the Contract unit price per each complete in place.

5.2 When new plant material has been ordered, payment will be made for furnishing and planting such plants under the appropriate item.

**Pay item and unit:**

658.__	Transplantation (Specific Plant Material)	Each
--------	---	------

**SECTION 692**

**SECTION 692 -- MOBILIZATION**

**Description**

**1.1** This item shall consist of preparatory work and operations, including, but not limited to, those necessary to the movement of personnel, equipment, supplies, and incidentals to the site of the work; and for all other work and operations which must be performed or for costs which must be incurred prior to beginning work on the various items.

**Method of Measurement**

**4.1** This item will be measured as a unit.

**Basis of Payment**

**5.1** Partial payments for this item will be made approximately as follows:

- (a) When 5 percent of the original Contract amount is earned, the accumulated total to be paid will be 25 percent of the amount bid, or 2-1/2 percent of the original Contract amount, whichever is the lesser.
- (b) When 10 percent of the original Contract amount is earned, the accumulated total to be paid will be 50 percent of the amount bid, or 5 percent of the original Contract amount, whichever is the lesser.
- (c) When 25 percent of the original Contract amount is earned, the accumulated total to be paid will be 60 percent of the amount bid, or 6 percent of the original Contract amount, whichever is the lesser.
- (d) When 50 percent of the original Contract amount is earned, the accumulated total to be paid will be 100 percent of the amount bid, or 10 percent of the original Contract amount, whichever is the lesser.

**5.2** Upon completion of all work, payment of any amount bid for this item in excess of 10 percent of the original Contract amount will be paid.

**5.3** Upon written request by the Contractor made within 30 days of the Award of Contract, an amount equal to 25 percent of the amount bid for this item or 1 percent of the Contract amount, whichever is lesser, will be paid. Further partial payments will be made according to the schedule in 5.1.

**5.4** The total sum of all payments will not exceed the original Contract amount bid for this item, regardless of the fact that the Contractor may have, for any reason, shut down his work on the project or moved equipment away from the project and then back again.

**5.5** When the item for mobilization is not included in the Proposal Form, the costs as described in the item will not be paid for directly, but shall be considered incidental to other items in the proposal.

**Pay item and unit:**

692.	Mobilization	Unit
------	--------------	------

**SECTION 693 -- TRAINING PROGRAMS****Description**

**1.1** This specification amplifies and interprets the requirements for the training program established by the Federal Aid Program Manual, Vol. 6, Ch. 4, Sec. 1, Subsec. 2, Attach. 2 entitled “ Training Special Provisions” and hereinafter referred to as the Training Program.

**1.2** The primary objective of the Training Program is to provide equal employment opportunity to minorities and disadvantaged persons by providing training and upgrading with the goal of reaching journey worker status and retaining them in the highway construction industry. However, the training commitment is not intended, and shall not be used, to discriminate against any applicant for training, whether a member of a minority group or not.

**1.3** The Contractor may determine how many, if any, of the trainees are to be trained by Subcontractors. However, the Contractor shall have the primary responsibility for meeting the training requirements. The number of trainees to be trained under this Contract is shown in the proposal.

**Requirements****3.1 Recruiting.**

**3.1.1** The Contractor shall ensure that the training and promotion of all employees will be considered on a non-discriminatory basis, and will advise employees and applicants for employment of available training programs and entrance requirements for these programs.

**3.1.2** The Contractor shall actively pursue enrollment of minorities and women into the program by conducting a systematic recruiting effort through public and private sources likely to yield minorities and women trainees. To the extent that such persons are available in a reasonable recruiting area, the Contractor shall be able to demonstrate the steps that were taken in this pursuit.

**3.1.3** The Contractor shall take positive steps to prevent any employee from being employed as a trainee in any classification in which the employee has successfully completed a training course leading to journey worker status or in which the employee has been employed as a journey worker. The Contractor may meet this requirement by including appropriate questions in the employee application or by other means. The Contractor's records shall document the findings.

**3.2 Orientation and Counseling.**

**3.2.1** The Contractor shall provide pre-job orientation to new employees entering the training program. This will include discussing the advantages and disadvantages of construction work, namely the seasonality of work in New Hampshire, the mobility necessary, safety hazards and requirements, weather conditions, etc. The Contractor shall also familiarize the trainee with the construction industry informing the trainee of the trainee's responsibility to the Contractor and the Contractor's responsibility to the trainee. Also, the Contractor shall stress the importance of safety on the job.

**3.2.2** The Contractor shall be responsive to any potential problems that may develop in the program. The Contractor shall work closely with all persons involved in the training program providing guidance and counseling to trainees and taking positive steps to resolve any misunderstandings, ensuring a successful training experience.

**3.3 Training.**

**3.3.1** As specified in the Training Program, the Contractor is required to submit to the Engineer for approval the number of trainees to be trained in each selected classification along with the training program and the intended starting time for each trainee. This shall be done prior to commencing construction allowing a reasonable time frame for the Engineer to study the Contractor's request.

**3.3.2** The Contractor may use programs as provided by the Engineer or may use any training program approved by the Department of Labor or by the FHWA as of the date of proposed use. The Contractor shall notify the Engineer if he plans to use such programs.

**3.3.3** The Contractor's on-site Equal Employment Opportunity (EEO) Officer shall work with Federal and State agencies and unions, as required, and with on-site superintendents and supervisors to structure an acceptable detailed training program.

**3.3.4** The number of trainees shall be distributed among the work classifications on the basis of the company's needs and the availability of journey workers in the various classifications within a reasonable area of recruitment. At a minimum, the training program for Contractors and Subcontractors, will adhere to the following guidelines:

**3.3.4.1** Training will be conducted and/or supervised by an experienced supervisor.

**3.3.4.2** Supervisors will be in contact with each trainee on a daily basis in order to ensure that proper training is being provided.

## SECTION 693

**3.3.4.3** A copy of the training program will be given to each trainee, along with an explanation of all requirements necessary to complete the program and what further opportunities for formal training may be expected upon successful completion.

**3.3.4.4** The detailed training program for the trainee will include:

- (a) Safety indoctrination in the use of tools, equipment, personal protection devices, first-aid, traffic control and other applicable skills;
- (b) A period of observation of operation prior to work assignment and performance;
- (c) Instruction and then participation in actual operations, care and maintenance of tools and/or equipment, where applicable;
- (d) A review period at the end of each week with the Contractor's project managers in order to encourage the trainee to ask questions and have meaningful discussions.

**3.3.5** Trainees will be paid at least 60 percent of the appropriate minimum journey worker's rate specified in the Contract for the first half of the training period, 75 percent for the third quarter of the training period, and 90 percent for the last quarter of the training period. The reduced rate, though, shall not be less than \$7.00 per hour with the exception that when the trainee is also enrolled in an approved apprentice or other training program, the rate of compensation approved by the Department of Labor shall apply without reduction.

### **3.4 Promotion and Retention.**

**3.4.1** The Contractor shall periodically review the training and promotion potential of minority and female employees and shall encourage eligible employees to apply for such training and promotion, to provide every opportunity for their upgrading within the Company.

**3.4.2** The Contractor shall be responsible to document its effort to promote and retain minorities and females within the construction industry.

### **3.5 Reporting.**

**3.5.1** The Contractor shall maintain weekly records of training provided to each trainee. In addition, the Contractor shall complete a quarterly report for each trainee receiving training under this specification, furnishing the following information on forms supplied:

- (a) Contractor's name and address.
- (b) Trainee's name, address, age, social security number, ethnic group designation, and whether trainee is a new hire or is being upgraded.
- (c) A summary of previous training received on other Contracts under approved training programs.
- (d) The job classification for which training is provided, the date training started, and the type training (apprenticeship or other) to be provided.
- (e) The hours of training provided to the trainee during the quarter.
- (f) The total hours of training remaining to complete the approved training program.
- (g) Reasons for the termination if training was terminated prior to completion of the approved program.

**3.5.2** The Contractor shall submit reports for any training under this specification which is provided by any of his Subcontractors.

**3.5.3** The Contractor shall submit the quarterly reports by the 15th day of the month following the end of the quarter. The original of the report shall be furnished to the trainee and two copies furnished to the Engineer.

### **Method of Measurement**

**4.1** The Contractor will have fulfilled his training responsibilities if he has provided acceptable training to the number of trainees specified in the Contract.

**4.2** On this project, permission may be given by the Engineer to pay for more than the number of trainees specified in the Contract, provided the Contractor proposes acceptable training programs to meet his needs and the needs of the industry.

### **Basis of Payment**

**5.1** Progress payments may be made to the Contractor based on 80 cents for each hour of the training provided.

**5.2** No payment shall be made to the Contractor if either the failure to provide the required training, or the failure to hire the trainee as a journey worker, is caused by the Contractor and there is evidence of a lack of good faith on the part of the Contractor in meeting these requirements.

**5.3** The Bidder's attention is called to the dollar amount inserted in the proposal under this item, which dollar amount represents \$600 times the number of workers specified to be trained under the program. This figure must not be altered by the Bidder in his proposal, and must be included to obtain the grand total of the bid.

**5.4** Payment of the amount set in the proposal will not be on a lump sum basis. Payment will be made to the Contractor at the rate of \$0.80 per hour (whether or not the time worked is overtime), for the hours worked by a trainee.

**Pay item and unit:**

693.	On-the-Job Training of Unskilled Workers	Dollar
------	--	--------

**SECTION 698 -- FIELD FACILITIES****Description**

**1.1** Under this section, the Department will pay for the use of Contractor owned and Contractor maintained field offices Type A, Type B, Type C, Type D and physical testing laboratories set-up and maintained by the Contractor during the construction of the project. This work will include installing, leveling, maintaining, and removing facilities and providing the required equipment and services. The location of the facilities shall be within approximately ¼ mile of the project limits and subject to the approval of the Engineer.

**Materials**

**2.1 General.** Housing for field offices and laboratories shall be mobile office space or building office space, which meet the following minimum requirements:

**2.1.1 Field Office Type A.**

Dimensions:	Shall meet the minimum size requirements as described by the Special Provision included in the Proposal.
Interior:	Shall meet the minimum size requirements as described by the Special Provision included in the Proposal.
Lavatory:	Built-in lavatory and toilet facilities with hot and cold water.
Electrical:	Adequate overhead lighting at each work area and two power outlets per room, including one exterior outlet light near entrance.
Air Conditioner(s):	Central air conditioning or a sufficient number of individual units to maintain a maximum temperature of 78° F.
Heat:	Thermostatically controlled to maintain a minimum temperature of 68° F.
Weatherproofing:	Roof, sides, and floor shall be maintained weatherproof at all times.

**2.1.2 Field Office Type B.**

Dimensions:	Minimum of 650 ft <sup>2</sup> of nominal floor space and minimum of 7 ft. in height.
Interior:	Minimum of three partitioned areas. One area shall be approximately 120-150 ft <sup>2</sup> for the installation of all computer components with interior door and lock. Another area shall be approximately 250 ft <sup>2</sup> for use as a conference room. Each major area shall have telephone plug-in jacks. The computer area shall have an additional telephone jack for the computer.
Lavatory:	Building office space: Built-in lavatory and toilet facilities with hot and cold water. Mobile office space: Portable toilet facilities per 2.1.5
Closets:	Built in, approximately 22 in deep by 3 feet wide.
Windows:	Minimum of two per partitioned area with locks and screens providing cross ventilation.
Doors:	Minimum of two with locks.
Electrical:	Adequate overhead lighting at each work area and two power outlets per room, including one exterior outlet light near entrance.
Air Conditioner(s):	Central air conditioning or a minimum of two individual units (one in the computer area) sized to maintain a maximum temperature of 78° F.
Heat:	Thermostatically controlled to maintain a minimum temperature of 68° F.
Weatherproofing:	Roof, sides, and floor shall be maintained weatherproof at all times.

**2.1.3 Field Office Type C.**

Dimensions:	Minimum of 300 ft <sup>2</sup> of nominal floor space and minimum of 7 ft. in height.
Interior:	Minimum of two partitioned areas, one being approximately 125 ft <sup>2</sup> with interior door and lock.
Lavatory:	Building office space: Built-in lavatory and toilet facilities with hot and cold. Mobile office space: Portable toilet facilities per 2.1.5
Closets:	Built in, approximately 22 in deep by 3 feet wide.
Windows:	Minimum of four with locks and screens providing cross ventilation.

Doors:	Minimum of two with locks.
Electrical:	Adequate overhead lighting at each work area and two power outlets per room, including one exterior outlet light near entrance.
Air Conditioner(s):	Central air conditioning or a minimum of two units (one in the computer area) sized to maintain a maximum temperature of 78° F.
Heat:	Thermostatically controlled to maintain a minimum temperature of 68° F.
Weatherproofing:	Roof, sides, and floor shall be maintained weatherproof at all times.

#### 2.1.4 Field Office Type D and Field Laboratory.

Dimensions:	Minimum of 200 ft <sup>2</sup> nominal floor space and a minimum of 7 ft. in height.
Windows:	Minimum of two with locks and screens providing cross ventilation.
Lavatory:	Building office space: Built-in lavatory and toilet facilities with hot and cold water. Mobile office space: Portable toilet facilities per 2.1.5.
Closets:	Built in, approximately 22 in deep by 3 feet wide.
Doors:	Minimum of one with lock.
Electrical:	Adequate overhead lighting at each work area and two power outlets per room, including one exterior outlet.
Air Conditioner:	Central air conditioning or individual unit(s) sized to maintain a maximum temperature of 78° F.
Heat:	Thermostatically controlled to maintain a minimum temperature of 68° F.
Weatherproofing:	Roof, sides, and floor shall be maintained weatherproof at all times.

**2.1.5** Toilet facilities for mobile office space shall be a separate facility fabricated from steel, fiberglass, or wood, housing a portable chemical toilet, provided by the Contractor. This building shall be well ventilated, shall conform to State law, and shall have a vented chemical tank and a separate urinal. This facility should also be equipped with water-less hand cleaner/sanitizer.

**2.1.5.1** For mobile office space, non-operational toilets and sinks shall be removed so that the space can be used for additional storage. Any holes or exposed plumbing left behind due to the removal of the toilet and sink shall be adequately protected.

## 2.2 Field Office Equipment.

### 2.2.1 Equipment Required for all Field Offices.

Water Cooler:	1, new or like new 5 gallon capacity, bottled water supplied and maintained.
MUTCD:	The current edition of the Manual on Uniform Traffic Control Devices for Streets and Highways and any supplements or amendments thereto, available from the Superintendent of Documents, U.S. Government Printing Office, Washington, DC 20402.
Measuring Wheel:	1, 15" minimum diameter with capacity to record up to 10,000 feet to the tenth of a foot, built-in stand, and storage case.
4' direct reading level	
10' metal straight edge:	Light-weight metal straightedge with a rectangular cross-section of 2 by 4"
Marking Paint:	Adequate supply, lead-free, non-clogging; color as ordered by the Engineer.
Pencil Sharpener:	1, standard size.
Calculator/Adding Machine	1, desktop print/display with minimum of ten digits.
Facsimile Machine:	This machine shall have the capability of sending and receiving 8-1/2 x 11 in on paper on a single separate committed telephone line. The following minimum specifications shall also apply: Transmission time: 16 seconds per page at standard resolution Transmission speed: 10ms/line @ 98 lines/in. Reception speed: 20ms/line @ 98 lines/in. Document length: 14.5" maximum, 4" minimum Auto document feed: 15 pages maximum Horiz. Print resolution: 203 pixels/in. Vertical print resolution: 98 lines/in., standard All connections and supplies necessary to allow successful operation of this machine shall be provided by the Contractor.
Thermometer:	1, indoor/outdoor type.

**SECTION 698**

Trash Receptacle:	1, per portioned space including trash bags.
Three Hole Punch	1, each.
Vacuum Cleaner:	1, electric (5hp minimum), utility shop-vac (10 gal capacity minimum) with 25 ft. extension cord.
Floor Broom/Dust Pan:	1 each.
First Aid Kit:	Shall contain a minimum of: 20-adhesive bandages, 3/4" wide. 1-first aid tape, 1/2 by 180" 1-flexible gauze bandage, 2 by 126" 1-flexible gauze bandage, 4 by 126" 1-triangular bandage 10-antiseptic swabs 3-sterile pads, 3 by 3" 3-ammonia inhalants antiseptic cream aspirin eyewash kit poison ivy cream scissors tweezers 1, current first aid book bug and/or tick repellent
Rain Gauge:	1, constructed from a clear material, minimum 1/4" permanently marked graduations, minimum 6" capacity with mounting bracket.

**2.2.2 Additional Equipment for Field Office Type A, Type B, Type C, and Type D**

Water:	Type A: Water service to supply lavatory
Fire Extinguisher:	Type A, B & C: 2, multi-purpose (A, B, C), dry powder, minimum 5 lb. size. Type D: 1, multi-purpose (A, B, C), dry powder, minimum 5 lb. size.
Office Desks:	Type A: per Special Provision included in the Proposal. Type B: five furnished with drawers. Type C: four furnished with drawers. Type D: one furnished with drawers.
Desk Chairs:	Type A: Per Special Provision in the Proposal. Type B: five Type C: four Type D: one
Conference Table:	Type A: Per Special Provision included in the Proposal. Type B & C: 1, minimum dimensions 8 ft. by 2.5 ft.
Folding Chairs:	Type A: Per Special Provision included in the Proposal. Type B: ten Type C & D: four
Drafting tables	Type A: Per Special Provision included in the Proposal. Type B: 2, at least 6 ft. by 3 ft. - 3", approximately 3 ft. high, with two drafting stools per table. Type D: 1, at least 6 ft. by 3 ft.-3in., approximately 3 ft. high, with two drafting stools per table.
Copier:	1, desktop, letter and legal size, minimum of eight copies per minute, reduction and enlarging capability with supplies and maintenance.
File Cabinet:	1 four-drawer, or 2 two-drawer, fire resistant, legal size; inside dimension approximately 10 by 15 by 26" each, with lock(s) and key(s). The file shall bear an Underwriters Laboratories "C" Label - 350°F for one hour, inside surface.
Plan Rack or File:	Type A & B: two, for 2 by 3 ft. prints Type C & D: one, for 2 by 3 ft. prints



**2.2.2.1** Desk chairs and drafting stools shall be 5 pedestal on wheels and adjustable with back support. All office furniture shall be in good, safe working order and condition.

**2.2.3** The Contractor Shall Provide Additional Equipment as Required by the Special Provision Provided in the Contract Proposal.

**2.2.4** The field office Type D shall also include the following testing equipment for determining gradation of gravels. This testing equipment shall be maintained in a satisfactory condition.

- (a) Balance: triple beam, at least 2000 grams capacity, sensitive to 0.1 gram, including carrying case.
- (b) Field scale: at least 70 lb. capacity, sensitive to 0.01 lb.
- (c) Hot plate or stove: two-burner, electric or bottled gas.
- (d) Sieves: set of U.S. Standard 8" brass, 2" high, consisting of one each No. 16 and No. 200 sieves, with pan and cover.
- (e) Shaker: motor driven, for 8" sieves.
- (f) Riddles: set of 16" wood, metal or plastic consisting of one each 3", 2", 1-1/2", 1", 3/4" and No. 4.
- (g) Canvas: heavy, 5 by 5 ft, for quartering samples.
- (h) Miscellaneous small tools and containers: shovels (one round pointed and one square pointed), assorted pans such as cake tins, and two pails.
- (i) Proctor mold: 4", capacity 1/30 ft<sup>3</sup> (AASHTO T 99).
- (j) Proctor hammer: 5.5 lb, free fall of 12" (AASHTO T 99).
- (k) Straight edge: steel (1-1/2 to 2 in wide), with a 12" beveled edge.
- (l) Moisture determination apparatus (Speedy Moisture Tester): calcium carbide type, 20 gram or 26 gram size.

**2.3 Field laboratory equipment.** The physical testing laboratory shall be provided with the scientific equipment required to perform physical tests for embankment compaction and grading, and for determining the suitability of the base course materials in conformity with standard AASHTO procedure. Following is a list of minimum equipment required to be maintained in a satisfactory condition for the use of the Engineer and the Contractor:

- (a) Proctor mold: 4", capacity 1/30 ft<sup>3</sup> (AASHTO T 99).
- (b) Proctor hammer: 5.5 lb, free fall of 12" (AASHTO T 99).
- (c) Straight edge: steel (1-1/2 to 2 in wide), with a 12" beveled edge.
- (d) Balance: triple beam, at least 2000 grams capacity, sensitive to 0.1 gram, including carrying case.
- (e) Field scale: at least 70 lb. capacity, sensitive to 0.01 pounds.
- (f) Hot plate or stove: two-burner, electric or bottled gas.
- (g) Shaker: motor driven, for 8" sieves.
- (h) Sieves: set of U.S. Standard 8" brass, 2" high consisting of one each No. 4, 8, 16, 50, 100, and 2 each No. 40 and 200 sieves, with pan and cover.
- (i) Riddles: set of 16" wood or metal, consisting of sizes 3 in, 2 in, 1-1/2 in, 1 in, 3/4 in, 1/2 in, 3/8 in, and No. 4.
- (j) Canvas: heavy, 5 by 5 ft., for quartering samples.
- (k) Moisture determination apparatus (Speedy Moisture Tester): calcium carbide type, 20 gram or 26 gram size.
- (l) Sieve shaker: mechanical, for gravel, (mounted outside and independent of the laboratory building) holding 18 by 24" tray including 2 in, 1-1/2 in, 1 in, 3/4 in and No. 4 screens.
- (m) Fire extinguisher: 1, multi-purpose (A,B,C) (dry powder) minimum 5 lb. size.
- (n) Graduate: 100 mL, plastic.
- (o) Miscellaneous small tools and containers as necessary: Such as shovels (one round pointed and one square pointed), crowbar, pickaxe, 6" blade knife, sampling spoon, small trowel, measuring scoop, assorted pans similar to roasting pans and cake tins, and a floor broom.
- (p) Bench oven: electric, 110 volt, minimum volume 7.5 cubic feet.
- (q) Sample splitter: minimum chute width 1"

**2.3.1** The laboratory shall be furnished with a heavy work table approximately 3 ft. high by 3 ft. wide and extending the length of the building. Suitable shelves and benches shall be provided as directed.

**2.3.2** The laboratory shall be equipped with an elevated clean water tank having a minimum capacity of 275 gal which shall be supplied with potable water as directed. The tank shall be piped to a faucet at an approved sink within the laboratory.

**2.3.3** To provide a suitable foundation for the mold to rest on when the AASHTO T 99 density test is being performed, a solid block of concrete approximately 18" deep, having a flat top approximately 1 ft. square shall be set practically flush in the ground at an approved location near the field laboratory.

**2.3.4** This field laboratory and equipment is in addition to any other requirements specified in Sections [Section 401](#) and [520](#).

## SECTION 698

**2.4 Miscellaneous Office Supplies.** In addition to the materials listed in 2.1, 2.2 and 2.3, upon written request the Engineer may require the Contractor to furnish miscellaneous office supplies such as field books, cross section paper, loose-leaf binders, etc., as appropriate.

### Construction Requirements

#### 3.1 Facilities.

**3.1.1** Field offices and field laboratories shall be on the project, leveled and ready for use prior to the start of any operations. Acceptance of the physical testing laboratory will not be given until the equipment has been inspected and approved by representatives of the Bureau of Materials and Research. Testing equipment shall be calibrated by the Contractor in accordance with 106.03. These facilities shall be removed when the project is completed unless released earlier by the Engineer.

**3.1.2** When field offices or field laboratories are to be placed on private property, the costs incidental to such placement shall be borne by the Contractor. Prior to Acceptance of the Work, the area shall be restored to the acceptance of the property owner and the Engineer. A written release from the property owner will be required.

**3.1.3** Field offices and field laboratories shall not be combined, nor shall they be combined with the scale house or other similar structure.

**3.1.4** Field offices and toilet facilities shall be for the exclusive use of Department personnel.

#### 3.2 Maintenance, Service, and Utilities.

**3.2.1** The Contractor shall furnish the following for a field office Type A, Type B, Type C, Type D or physical testing laboratory:

- (a) Fuel. Adequate supply for heating and testing operations.
- (b) Electricity. A 3,000 watt, 115-125 volt AC facility for each field office and field laboratory. Independent generators shall be provided where commercial power is not available.
- (c) Telephone. Telephone service, telephone and telephone message recorder shall be provided in the field office. Telephone service shall include a separate line for the telephone with 2 jacks one adjacent to the computer, a separate voice-grade, touch-tone dialing line for the computer modem, and a third voice-grade, touch-tone dialing line for the FAX machine. All necessary hardware and appurtenances for the computer modem shall be provided to the computer room, when a computer is supplied.
- (d) Sanitary. Toilet facilities as described in 2.1.5 shall be serviced and maintained in a sanitary condition.
- (e) Maintenance, including trash pickup and disposal.
- (f) First Aid Kit. Shall be maintained and restocked as necessary or as directed.
- (g) Access. Parking areas, including entrances and exits shall be adjacent to the field offices and maintained for year round access. This includes snow removal as long as field offices are occupied and preparing access areas so non-paved surfaces won't track in wet conditions.

**3.2.2** The Contractor shall maintain all furnished equipment in good working condition and shall provide replacement or repair of equipment due to breakdown, damage, or theft. within two (2) working days of notice.

### Method of Measurement

**4.1** Field offices and Physical testing laboratory of the type specified and used on the project by the Engineer will be measured by the month, from the date each field office or physical testing laboratory is completely furnished and ready for occupancy, as determined by the Engineer, to the date that it is released back to the Contractor. Periods of less than one month will be computed at the rate of 1/30 of the unit price per month for each day of occupancy by the Engineer.

### Basis of Payment

**5.1** Payment for each accepted Field Office or physical testing laboratory, installed as specified, will be made at the corresponding Contract unit price per month. Such payment shall constitute full compensation for furnishing and erecting the field office or physical testing laboratory; for providing the specified utilities and maintaining the field office or physical testing laboratory and its equipment throughout the period of usage by the Engineer, including periods of project suspension and for restoration of the field office or physical testing laboratory is needed on the project.

**5.1.1** The costs of all project related telephone service, including installation; monthly fees; taxes; any activation fees; internet access as specified; unlimited local calls; and toll calls up to \$300.00 per month shall be paid by the Contractor, subsidiary to the field office. The Department will reimburse the Contractor for any toll calls incurred by State personnel above \$300.00 per month as provided for in 109.04.

**5.2** No payment will be made for periods of time in which the Contractor fails to comply with any of the requirements of this specification.

**5.3** No payment will be made for time periods for which the Contractor fails to complete the Work on time as specified in [108.07](#).

**5.4** The material cost of miscellaneous office supplies only, will be paid for as provided in [109.04](#). No payment for labor costs incidental to procuring these supplies will be authorized.

**Pay items and units:**

698.11	Field Office Type A	Month
698.12	Field Office Type B	Month
698.13	Field Office Type C	Month
698.14	Field Office Type D	Month
698.2	Physical Testing Laboratory	Month

## SECTION 699

### ***SECTION 699 -- MISCELLANEOUS TEMPORARY EROSION AND SEDIMENT CONTROL***

#### **Description**

**1.1** This work shall consist of miscellaneous temporary measures necessary to control erosion and sedimentation and protect water quality through the life of the Contract. This work includes, but is not necessarily limited to, the use of pipes, berms, dams, sluices, sediment basins, fiber mats, silt booms, filter fabrics, netting, gravel, slope drains and other erosion control devices or methods.

**1.2** The miscellaneous temporary erosion and sediment control provisions contained herein shall be coordinated with the permanent erosion control features specified elsewhere in the Contract to the extent practicable to ensure economical, effective and continuous erosion and sediment control throughout the construction and post construction periods.

**1.3** The extent of erosion and sediment control will depend upon many factors, among which are the amount and type of soils which may be exposed to erosion.

**1.4** The Department recognizes the importance of providing proactive effective erosion and sediment control and that siltation could adversely affect the ecology.

#### **Materials**

**2.1** Material requirements shall be as specified in 645.2 or as directed.

**2.2** Temporary slope drains may be constructed of rigid or flexible pipe, fiber mats, rubble, sluices, plastic sheets or other acceptable material that will protect slopes from erosion.

**2.3** Fertilizer and soil conditioners shall meet the requirements of 642 and 643.

#### **Construction Requirements**

**3.1** Construction requirements shall be as specified in 645.3 or as directed.

**3.2** No work requiring erosion control shall commence until the Storm Water Pollution Prevention Plan (SWPPP) has been approved.

#### **Method of Measurement**

**4.1** Work authorized under this section will be measured as provided in 109.01; however, when such work falls within the specifications for another Contract item, the work will be measured according to the method of measurement for that Contract item.

#### **Basis of Payment**

**5.1** Payment for work authorized under this item will be made on a dollar basis according to 109.04 Method B, C or D.

**5.1.1** The cost of construction and maintenance of temporary erosion and sediment control devices not provided for under a separate Contract item will be included for payment under this item.

**5.2** Payment for the following work will not be allowed under this item.

**5.2.1** The temporary diversion of water during culvert construction and the dewatering, pumping and discharge of water at cofferdams and bridge sites shall be subsidiary to the pertinent Contract item. However, settlement basins, detention ponds or other approved sediment treatment measures required will be included for payment under this item unless otherwise shown on the plans.

**5.2.2** Temporary erosion and sediment control measures required due to the Contractor's failure to install permanent controls as a part of the scheduled work, negligence, carelessness or type of operation outside the generally accepted standard construction practices within the State shall be at the Contractor's expense.

**5.2.2.1** Temporary erosion and sediment control measures required at off-site areas including, but not limited to, haul roads, equipment and material storage sites, material pits, material processing sites and disposal areas shall be at the Contractor's expense.

**5.2.3** Erosion control measures including dust control required for stockpiles of materials subject to wind or water erosion shall be at the Contractor's expense.

**5.2.4** Repair and maintenance of damaged or failed slopes, until project acceptance as stated in 104.13 shall be at the Contractor's expense.

**5.3** Direct costs plus project Engineering costs incurred by the Department to provide corrective temporary erosion and sediment control deemed by the Engineer to be required and not provided by the Contractor will be charged to the Contractor and appropriate deductions made from the Contractor's estimates.

**5.4** The dollar amount inserted in the Proposal under this item is the amount the Department has set for miscellaneous temporary erosion and sediment control measures. This amount must not be altered by the Bidder on the Proposal and must be included to obtain the Grand Total of the bid.

**5.4.1** Payment of the amount set in the Proposal will not be a lump sum. Only the dollar value as authorized will be paid.

**5.5** When no money for this item is included in the Proposal under this item, it is anticipated that this work will be of minor significance and will be the responsibility of the Contractor.

**Pay item and unit:**

699.	Miscellaneous Temporary Erosion and Sediment Control	Dollar
------	--	--------



## DIVISION 700 -- MATERIALS

## SECTION 702 -- BITUMINOUS MATERIALS

Table 702-1 – Anionic Asphalt Emulsion

Type Grade	Rapid-Setting											
	RS-1		RS-1h		RS-2		HFMS-2		MS-4		MS-5	
	min	max	min	max	min	max	min	max	min	max	min	max
<b>Test Requirements:</b>												
<b>Emulsions:</b>												
Viscosity, Saybolt Furol at 77 °F, s	20	100	20	100			100 see (1)		50	500	50	500
Viscosity, Saybolt Furol at 122 °F, s					75	400						
Storage stability test, 24-h, %		1		1		1		1		1		1
Coating ability and water resistance:												
Coating, dry aggregate								good		75+		75+
Coating, after spraying								fair		see (2) (3) (4)		see (2) (3) (4)
Coating, wet aggregate								fair				
Coating, after spraying								fair				
Sieve test, %		0.10		0.10		0.10		0.10		0.10		0.10
Oil Distillate, %									2.0	7.0	0	3.0
Residue by distillation, %	55		55		63		65		65		65	
<b>Residue from distillation test:</b>												
Penetration, 77 °F, 100 g, 5 s	100	200	40	90	100	200	100	200	200		150	250
Solubility in trichloroethylene, %	97.5		97.5		97.5		97.5		97.5		97.5	
Float test, 140 °F, s							1200		50		100	

Table 702-2 -- Cationic Asphalt Emulsion

Type Grade	Rapid-Setting			
	CRS-1		CRS-1h	
	min	max	min	max
<b>Test Requirements:</b>				
<b>Emulsions:</b>				
Viscosity, Saybolt Furol at 77 °F, s	20	100	20	100
Viscosity, Saybolt Furol at 122 °F, s				
Storage stability test, 24-h, %		1		1
Sieve test, %		0.10		0.10
Oil Distillate, %		3		3
Residue by distillation, %	55		63	
<b>Residue from Distillation Test:</b>				
Penetration, 77 °F, 100 g, 5 s	100	200	40	90
Solubility in trichloroethylene, %	97.5		97.5	
Suggested spraying temperature, °C	25	60	25	60

**Footnotes:**

- (1) 50 + when material is used for sealing.
- (2) **Wet Coating:** Weigh 100 ± 0.5 g of aggregate, 20 to 30 mesh (0.85 to 0.60 mm) standard Ottawa sand, into a 600 mL glass beaker and add soft tap water, approximately twice the volume of that of sand. Weigh into the beaker containing the sand and water 8 ± 0.2 g of the emulsion at room temperature and mix for two minutes with a stiff spatula. Cover the mixture with approximately twice its own volume of tap water and pour the water off without further mixing. Repeat this process. After the second rinse, at least 75 percent of the sand shall remain coated.
- (3) **Stripping:** After evaluating the wet coating, place the mixture into a clear 600 mL glass beaker, cover the mixture with tap water, let stand for 12 to 16 hours, and examine. At least 75 percent of the sand shall remain coated.
- (4) The coating and stripping tests may be waived when MS-5 is used for sand sealing.

## SECTION 703 – AGGREGATES

Table 703-1 -- Required Grading, Graded Coarse Aggregates

Standard Stone Size	#4	#357	#467	#57	#67	#7	#89
Min to Max	3/4" to 1-1/2"	No. 4 to 2"	No. 4 to 1-1/2"	No. 4 to 1"	No. 4 to 3/4"	No. 4 to 1/2"	No. 16 to 3/8"
<b>Sieve Size</b>	<b>Percentage by Weight Passing</b>						
2-1/2"	---	100	---	---	---	---	---
2"	100	95-100	100	---	---	---	---
1-1/2"	90-100	---	95-100	100	---	---	---
1"	20-55	35-70	---	95-100	100	---	---
3/4"	0-15	---	35-70	---	90-100	100	---
1/2"	---	10-30	---	25-60	---	90-100	100
3/8"	0-5	---	10-30	---	20-55	40-70	90-100
No. 4	---	0-5	0-5	0-10	0-10	0-15	20-55
No. 8	---	---	---	0-5	0-5	0-5	5-30
No. 16	---	---	---	---	---	---	0-10
No. 50	---	---	---	---	---	---	0-5



## SECTION 707

### SECTION 707 -- CEMENT MORTAR

#### Description

1.1 Cement mortar shall consist of either Portland cement or masonry cement, mortar sand, and water.

#### Materials

2.1 Portland cement shall conform to 520.2.1.

2.2 Mortar sand shall meet the requirements of AASHTO M 45 except as shown in Table 707-1.

**Table 707-1 - Gradation of Mortar Sand**

Sieve Size	Percent by Weight Passing
No. 8	100
No. 16	60 - 100
No. 50	15 - 35
No. 100	2 - 15
No. 200	0 - 5

Note: In lieu of the above, fine aggregate graded in accordance with 520.2.2.2.2 may be used in mortar for mortar rubble masonry and with concrete blocks for catch basins and drop inlets.

2.3 Testing for impurities shall comply with AASHTO T 21. Results that are darker than the standard shall be cause for rejection, except as provided in 2.3.1.1.

2.3.1 Sand for mortar not conforming to 2.3.1 shall be tested in accordance with AASHTO T 71 and shall meet the requirements of 5.2.3 of AASHTO M 45.

2.4 Water shall meet the requirements of 520.2.5.

#### Proportions and Procedures

3.1 Mortar shall be composed of one part by volume of Portland cement, except as specified in 3.4, and two parts by volume of damp loose mortar sand with water as necessary to obtain required consistency.

3.2 Hand mixing of mortar shall require thorough mixing of the dry cement and damp sand, in a clean, tight mortar box until the mixture is of a uniform color. Water shall be added in such quantity as to form a mortar having the desired consistency.

3.3 Machine mixing of mortar shall require mixing of the dry cement and damp sand, then adding water, to an approved mixer, for not less than three minutes to reach workability.

3.4 Cement for mortar in ashlar or for mortar squared stone masonry shall consist of Portland cement only.

3.5 Mortars shall be used and placed in final position within two and one-half hours after mixing.

3.6 Mortar for bridge curbs shall meet the requirements of 609.2.5 and shall be used as specified under 609.3.1.7.

**SECTION 708 -- PAINTS**

**708.01 Description.** These specifications are intended to specify paints that will meet service requirements for highway construction.

Paint shall be homogeneous, free of contaminant, and of a consistency suitable for use in the capacity for which it is specified. Finished paint shall be well ground, and the pigment shall be properly dispersed in the vehicle according to the requirements of the paint. The dispersion shall be of such nature that the pigment does not settle, does not cake or thicken in the container, and does not become granular or curdled. The paint shall be easily broken up with a paddle to form a smooth uniform product of the proper consistency and shall possess satisfactory properties in all respects which affect its application and curing.

The color shall match the established standard. The hiding power shall be sufficient to obtain complete hiding of the preceding coat with a single application when applied at normal spreading rates. The finish coat shall dry to a semi-gloss finish, unless specified otherwise.

The final color of the paint specified for the work shall conform to FED-STD-595B and the specific color number specified below. The Department may approve a manufacturer's standard color provided it is very similar to that specified and color chips are submitted for approval before the paint is shipped.

**Federal Standard Colors**

<b>Color</b>	<b>Federal Color Number</b>
Light Green	24272
Dark Green	24109
Dark Brown	20062
Aluminum	17178
White	17925
Black	27038

For paint material and application requirements for painting structural steel and steel portions of other structures, refer to 550, 556, a Special Provision for Section 550, Structural Steel, and a Special Provision for Section 556, Painting Existing Structural Steel in the project contract documents.

**708.02 Packaging.** All paint furnished must be shipped in original, sealed, strong, new containers having a capacity of not more than 5 gal each. The containers shall be equipped with a lever-type ring seal or a lug-type cover and wire bails. Each container shall be so filled that the net weight of the material in the can is the product of the weight per gallon determined at 75° F- 80° F and the specified gallon capacity of the can.

All containers of paint shall be clearly labeled with the following information:

- New Hampshire Paint Number, Name, and Color
- Name of Product
- Lot and Batch Number
- Date of Manufacture
- Volume and Weight of Contents
- Volatile Organic Compounds (VOC) Contents
- Instructions for opening, mixing, thinning and applying the paint
- Name and Address of Manufacturer

**708.03 Approval, Sampling and Testing.** The Contractor shall submit the complete paint system in writing to the Department for approval prior to use on the project. The Engineer shall be furnished with a Certificate of Compliance and Material Data Sheet for all paint prior to or upon delivery of painted structural steel to the project. (See 106.04.)

The paint may be sampled by lot either at the point of manufacture or application as required for testing by the Department to ensure compliance with material specifications prior to use. Samples of paint furnished for field use shall be submitted at least ten working days before application, in order to allow the Engineer time for testing and accepting the paint. The Engineer may permit application of the paint in a shorter time upon approval of the manufacturer's Certificate of Compliance by the Bureau of Materials & Research.

Unless otherwise provided, the materials entering into the composition of the paint shall conform to the requirements of the applicable ASTM and AASHTO standards and FSS covering such materials. Testing shall be in accordance with the latest test methods of the ASTM and AASHTO. However, the Department reserves the right to make use of any information or methods of testing to determine the quality of paint and paint materials.

**708.04 [blank]**

**708.05 Traffic Paint Identification.** To provide a means of identification, the applicable number and name taken from the following list, unless otherwise specified, shall be printed on the label.

**Traffic Paints**

NH 4.11	White Bead Binder
NH 4.12	Yellow Bead Binder

**General**

**1.1 General.** This specification describes ready-mixed traffic markings that shall be used as a base for reflective beads , or for use as a plain non-reflective marking. The marking shall be suitable for either bituminous or concrete surfaces.

**1.2** The paint shall be formulated and processed specifically for service as a binder for reflective beads, in such a manner as to produce maximum adhesion, refraction, and retroreflection. Any capillary action of the paint shall not be such as to cause complete coverage of the beads.

**1.3** The paint shall be well mixed in the manufacturing process and shall be properly ground when incorporating the pigments in order to conform to the requirements as specified.

**1.4** The paint shall not liver, thicken, curdle, gel, or otherwise show any objectionable properties during storage and shall be readily remixed manually to a smooth uniform consistency throughout.

**1.5** The paint shall dry on a road surface to a uniform noncracking film that will not darken in sunlight. It shall be formulated for application with mechanical line-marking equipment and shall meet the opacity (contrast ratio) properties specified herein. The paint is a substrate for binding glass beads so as to produce a highly weather resistant traffic line.

**Materials**

**2.1 Paint.** Paint shall be 100% acrylic, with or without methanol, rated non-combustible with the composition complying with the following:

**White Traffic Paint**

Property	Test Method	Requirements
Binder	ASTM D 2621 Infrared Analysis	Acrylic
Titanium Dioxide, Rutile Type II	ASTM D 1394	1 lb./gal. Min.
Total solids	ASTM D 3723	76% Min. by weight 62% Min. by volume
% Pigment	ASTM D 3723	58% Min. to 62% Max.
% Vehicle	ASTM D 3723	38% Min. to 42% Max
% Non-volatile in vehicle	ASTM D 3723	42% Min. by weight
Lead	ASTM D 3335	0.06% Max.
VOC	ASTM D 3960	1.25 lb./gal. Max.
Weight per gallon	ASTM D 1475	14.0 ± 0.3 lb./gal.
pH		9.6 Min.
Flash Point (Close Cup)	D 3278 Setaflash	> 140° F
Color	Without beads a minimum of 24 hours after application	Fed-Std-595B No. 37886 - White

## SECTION 708

### Yellow Traffic Paint

Property	Test Method	Requirements
Binder	ASTM D 2621 Infrared Analysis	Acrylic
Titanium Dioxide, Rutile Type II	ASTM D 1394	0.2 lb./gal. Min.
Total solids	ASTM D 3723	76% Min. by weight 62% Min. by volume
% Pigment	ASTM D 3723	58% Min. to 62% Max.
% Vehicle	ASTM D 3723	38% Min to 42% Max
% Non-volatile in vehicle	ASTM D 3723	42% Min. by weight
Lead	ASTM D 3335	0.06% Max.
VOC	ASTM D 3960	1.25 lb./gal. Max.
Weight per gallon	ASTM D 1475	13.55 ± 0.3 lb./gal.
pH		9.6 Min.
Flash Point (Close Cup)	D 3278 Setaflash	> 140° F
Color	Without beads a minimum of 24 hours after application	Fed-Std-595B No. 33538-yellow

2.2 In addition, all traffic paint shall comply with the following requirements:

Property	Test Method	Requirements
Viscosity (Krebs Units)	ASTM D 562	80 Min. to 92 Max. @ 77° F
Fineness of Grind	ASTM D 1210	4 Min.
Drying Time	-ASTM D 711 with wet film thickness of 5 mils NHDOT Test 2-Test plate-set for an hour	10 minutes Max. @ 77° F Uniformed film and no cracking or flaking
Flexibility	FSS TT-P-1952D, Section 4.5.5, using 1/2" mandrel bend	No Cracking or Flaking
Dry Opacity (contrast ratio)	ASTM D 2244 with a wet film thickness of 5 mils	0.96 Min.
Daylight Reflectance	Federal Test Method No. 141c	85% Min. for White Paint 50% Min. for Yellow Paint
Bleeding (ratio)	FSS TT-P-1952D	0.97 Min.
Scrub Resistance	ASTM D 2486	Pass 300 cycles
Freeze-Thaw Stability	FSS TT-P-1952D	≤ 10% change
Heat Stability (Krebs Units)	FSS TT-P-1952D	≤ 10% change

**2.2.1 Condition in Container:** The paint shall show no livering, skinning, mold growth, putrefication, corrosion of the container, or hard settling of the pigment in the container. Any settling shall be readily dispersed when stirred by hand with no persistent foaming.

**2.2.2 No Track Time:** Paint shall dry to a no tracking condition in no longer than 75 seconds. The “no tracking” condition shall be determined by actual application on the pavement at a wet film thickness of 20 mils with white or yellow paint covered with glass beads at a rate of 8 pounds per gallon. The paint lines for this test shall be applied with the striping equipment with the paint at temperatures between 85° - 105° F at the spray orifice. This maximum tracking time shall not be exceeded when the pavement temperature varies from 50° F to 120° F, and under humidity conditions of 80% or less providing that the pavement is dry. The “no tracking” time shall be determined by passing over the paint line three (3) minutes after paint application, in a simulated passing maneuver at a constant speed of 30 to 40 miles per hour with a passenger car. A line showing no visual deposition of the paint to the pavement surface when viewed from a distance of approximately 50 feet from the point where the test vehicle

has crossed the line shall be considered as showing “no tracking” and conforming to the requirement for field drying conditions. This field dry time test shall be used for production samples only.

**2.2.3 Dry Through (Early Washout):** A 15 mil wet film thickness paint sample placed immediately in a humidity chamber maintained at  $72.5^{\circ}\text{F} \pm 2.5^{\circ}\text{F}$  and  $90\% \pm 3\%$  relative humidity shall have a “dry-through” time less than or equal to paint film tested in accordance with ASTM D 1640, except that the pressure exerted will be the minimum needed to maintain contact between the thumb and film.

**2.3** Material Safety Data Sheets (OSHA Form 20 or equivalent) pertinent to all materials in this product shall be within the striping vehicle.

## APPENDIX A

## DUPLEX COATINGS - PAINT OVER GALVANIZING

Highlight these requirements:

- Apply galvanizing and paint within the same facility (see 1.2);
- Apply first coat of paint over galvanizing within a maximum 12-hour window (see 3.4.1).

## DESCRIPTION

**1.1 General.** This appendix specifies a duplex coating, consisting of hot dip galvanizing and a high-performance, shop-applied, paint system for fabricated steel products for exterior use, as shown on the plans or as directed.

**1.2 Duplex Coating Facility.** The galvanizer shall be qualified and have demonstrated a minimum of ten years' experience in the successful application of hot dip galvanizing using the dry kettle process, and a minimum of five years' experience in the successful application of paint over galvanizing within the same facility.

**1.3 Scope Of Work.** All fabricated products and components, as shown on the plans or as directed, shall be furnished with a duplex coating color finish as described. See Summary Table 1.3.

## MATERIALS

**2.1 Galvanizing.** Hot dip galvanizing shall conform to AASHTO M111 (ASTM A123) and utilize the dry kettle process in a bath of molten zinc. The galvanizing kettle shall contain special high grade zinc, nickel, and other earthly materials. The galvanizing process shall not include quenching with water or treatment with a chromate conversion coating. Provide thickness of galvanizing specified in the reference standards. Hardware shall be hot dip galvanized in conformance with AASHTO M232 (ASTM A153).

**2.2 Abrasives.** Provide abrasives that are dry and free of oil, grease, and corrosion-producing, or other deleterious contaminants. Provide an abrasive that is sized to produce a dense, consistent, sharp, angular, uniform anchor pattern with a profile height of 1.0-1.5 mils, unless the requirements of the coating manufacturer are more restrictive. The use of iron shot, steel shot, aluminum oxide grit, sand, or coal slag products as blast abrasives, and power wire brushes are NOT permitted. Use approved abrasives [e.g. garnet, stainless steel grit, Dupont StarBlast® XL (fractured), etc.] that will not leave a residue on the galvanized surface after blowing down with compressed air.

**2.3 Paint System.** The duplex coating shall be a two-coat shop-applied, high performance, paint system consisting of an epoxy polyamide intermediate coating and an aliphatic polyurethane topcoat applied over hot dipped galvanized (HDG) steel substrates. An alternative paint system applied over the hot dipped galvanizing consists of a single-component moisture-cure (SC MC) aromatic polyurethane intermediate coat with micaceous iron oxide, and an SC MC aliphatic polyurethane topcoat. For extra protection an additional clearcoat may be specified.

**2.3.1** Furnish intermediate and finish coat paint materials from Paint System A, B, C, or D in a NHDOT 550/556 Special Provision, or from Paint System A or B in the NEPCOAT Qualified Products List.

**2.3.2** The galvanizing-paint duplex system shall consist of the following generic type and coating thicknesses:

Coating	Description	Thickness
Galvanized:	Hot-dip galvanizing	per AASHTO
Surface prep:	SP1 Solvent Cleaning (as required); and SP7 Brush-Off Blast Cleaning, or approved mechanical means	per section 3.2.2
Intermediate	High build epoxy polyamide, or Single-component moisture-cure aromatic polyurethane with micaceous iron oxide	4-6 mils DFT
Finish	Aliphatic polyurethane, or Single-component moisture-cure aliphatic polyurethane	2-4 mils DFT

**2.3.3** Film thicknesses shall be as shown in 2.3.2 unless the paint manufacturer's recommended thickness range differs, in which case the manufacturer shall provide documentation that the range cited satisfies the Department's performance requirements.

**2.3.4** The maximum VOC limit is 2.8 lb/gal. at the time of application, including thinners.

**2.3.5** Use the same manufacturer for all coats on a given structure, including thinners and additives.

**2.3.6** Provide each coat of paint in sufficiently contrasting color to facilitate proper coverage and to distinguish it from previously applied coatings. The previous coat shall be hidden by application of each coat at the specified minimum thickness.

**2.3.7** Provide all paint materials in sealed, original, containers that are properly marked and labeled to allow verification, with applicable material safety data sheets, application precautions, instructions, and including the manufacturer's name, type of material, brand name, color, shelf life, purchase order number, lot and batch numbers, and quantity.

**2.3.8 Color.** The final color of the product shall be as specified (semi-gloss), closely matching the Federal Standard 595B, as follows:

Description	Federal Color #
DARK GREEN	24109
DARK BROWN	20062
BLACK	27038

**2.3.9 Touchup materials.** Repair and touch-up materials shall be supplied by the paint applicator and applied in accordance with the paint manufacturer's recommendations.

**2.3.10** The paint manufacturer shall certify in writing that the duplex coating facility applying the paint is certified to apply the paint by the coating manufacturer.

## 2.4 Equipment.

**2.4.1 Inspection Equipment.** Provide inspection equipment needed to verify the quality of the galvanizing, surface preparation, and paint application processes, including a Type II dry film thickness gage that can be calibrated, calibration standards, sling psychrometer and psychometric tables, and a mirror for use by the Department.

## DUPLEX COATINGS - PAINT OVER GALVANIZING

### 3.1 General.

**3.1.1** Provide all materials, equipment, and labor necessary to perform the scope of work whether or not the material or equipment is specifically identified in this Item. Conduct all galvanizing, surface preparation, paint application operations, handling, shipment, and installation in a workmanlike manner in conformance with SSPC-PA1, these requirements, and to the reasonable satisfaction of the Department.

**3.1.2 Basis of Design.** [blank]

**3.1.3 Specifications.** Perform the work in conformance to the Contract requirements, the reference standards, and the coating manufacturer's instructions, respectively.

**3.1.3.1 Reference Standards.** The latest edition of the following standards and regulations in effect at the time of the Bid form a part of this Specification. A copy of the reference standards applicable to the work shall be available at the shop facility for use by the Department's representative.

#### a. American Society for Testing and Materials (ASTM)

1. ASTM A123, Standard Specification for Zinc (Hot Dip Galvanized) Coatings on Iron and Steel Products
2. ASTM A153, Standard Specification for Zinc Coating (Hot Dip) on Iron and Steel Hardware
3. ASTM A385, Standard Practice for Providing High-Quality Zinc Coatings (Hot Dip)
4. ASTM A780, Standard Practice for Repair of Damaged and Uncoated Areas of Hot Dip Galvanized Coatings
5. ASTM D610, Standard Test Method for Evaluating Degree of Rusting on Painted Steel Surfaces
6. ASTM D6386, Standard Practice for Preparation of Zinc (Hot Dip Galvanized) Coated Iron and Steel Product and Hardware Surfaces for Painting.
7. ASTM D7803, Standard Practice for Preparation of Zinc (Hot Dip Galvanized) Coated Iron and Steel Product and Hardware Surfaces for Powder Coating

## SECTION 708

### b. American Association of State Highway & Transportation Officials (AASHTO)

1. AASHTO M111, Zinc (Hot Dip Galvanized) Coatings on Iron and Steel Products
2. AASHTO M232, Zinc Coating (Hot Dip) on Iron and Steel Hardware

### c. American Galvanizers Association (AGA)

1. The Inspection of Products Hot Dip Galvanized After Fabrication
2. *Powder Coating over Hot Dip Galvanized Steel*, Powder Coating Journal, Feb 2004, Philip Rahrig, AGA Executive Director
3. *Powder Coating over Galvanized Steel*, Tom Langill, AGA Technical Director, Feb 2010.

### d. Society for Protective Coatings (SSPC)

1. SSPC-SP 1, Solvent Cleaning
2. SSPC-SP 7 / NACE No. 4, Brush Off Blast Cleaning
3. SSPC-PA 1, Shop, Field, and Maintenance Painting
4. SSPC-PA 2, Measurement of Dry Film Thickness with Magnetic Gages

## 3.1.4 Submittals.

### 3.1.4.1 Surface Preparation and Painting Plan.

1. Provide a written plan to the Department for applying duplex coatings. Identify the manner of surface preparation, the paint system to be applied, film thickness, cure time between coats, repair materials and procedures of typical damage and defects in the duplex coating, and other information needed to successfully apply all coats of the duplex system.
2. Provide material product literature and MSD sheets for the coatings specified.
3. Verification samples. Submit two 3-inch by 6-inch samples of shop-applied duplex coatings and colors proposed for use for approval to the Department (Bureau of Bridge Design, Tel. 603-271-2731) a minimum two weeks prior to coating application. Samples shall be made of the same or comparable material and thickness as production pieces.
4. Submit a Certificate of Compliance stating that the requirements of the contract specifications have been met, in conformance to [106.04](#).

### 3.1.4.2 Substitutions or Approved Equals.

1. Substitutions or 'Approved Equals' are defined as meeting the aesthetic, durability, and all other performance criteria referenced in this specification, and shall be accompanied by proof that the Substitution or 'Approved Equal' meets or exceeds these criteria. Approval is the discretion of the Department. Coatings or processes not matching or exceeding the approved specified process and aesthetic, durability, and performance criteria shall be removed and replaced at the expense of the Contractor and all Subcontractors that were involved with the supply of and application of the non-conforming product.

## 3.1.5 Supplier Coordination.

1. **Fabricator-Galvanizer Coordination.** Prior to fabrication and final submittal of shop drawings to the Department, fabricators shall submit shop drawings to the galvanizer for all metal fabrications to receive shop-applied duplex coatings, to review fabricator's shop drawings for suitability of materials for galvanizing and coatings, and to coordinate any required modifications to fabrications required to be performed by the fabricator.
2. The supplier of steel products shall notify the galvanizer if the chemical composition of the steel to be galvanized exceeds the following limits in order to determine its suitability for processing: 0.25% carbon, 0.22% silicon, 0.04% phosphorous, and 1.3% manganese.

## 3.2 Hot Dip Galvanizing (HDG)

**3.2.1** Fabricated products shall meet the requirements of ASTM A385 (for material composition, cleanliness, drainage vents, etc.) prior to galvanizing, and galvanized surfaces shall meet the requirements of ASTM D6386 (preparing zinc surfaces for painting), as applicable and as stated herein.

1. Galvanizing: Galvanize materials in accordance with specified standards and this specification. Galvanizing shall provide an acceptable substrate for applied coatings. The dry kettle process shall be used to eliminate any flux inclusions on the surface of the galvanized material.
2. Prior to galvanizing, the steel shall be immersed in a preflux solution (zinc ammonium chloride). The preflux tank shall be 12-14 Baumé and contain less than 0.4 percent iron. The wet kettle process is prohibited.



3. Implement the following procedures to provide the appropriate surface for the material to be galvanized:
  - a) Utilize and regularly inspect a monitoring recorder to observe any variances in the galvanizing bath temperature.
  - b) The pickling tanks shall contain hydrochloric acid with an iron content less than 8 percent and zinc content less than 3 percent. Titrations shall be taken weekly at a minimum.
  - c) All chemicals and zinc content will be tested at least once a week to determine compliance with ASTM standards. All testing will be done using atomic absorption spectrometry or x-ray fluorescence (XRF) equipment at a lab in the galvanizing plant.

### 3.2.2 Surface Preparation of Hot Dip Galvanizing (HDG)

1. Prepare all surfaces in conformance to the requirements of this Item, ASTM D7803 and the approved Surface Preparation and Painting Plan provided under 3.1.4, Submittals.
2. Prior to painting, clean and prepare galvanized surfaces as necessary to remove detrimental contaminants. (See *Powder Coating over Galvanized Steel*, Feb 2010 Tom Langill for cautions regarding cleaning.) If applicable apply cleaning materials with clean lint-free rags or soft bristle brushes frequently changed to prevent reapplying contaminants. After cleaning, rinse thoroughly with hot water and allow the part to dry completely.
3. Prepare galvanized surfaces with SSPC-SP7, Brush-Off Blast Cleaning, using non-metallic abrasives at a reduced nozzle pressure as recommended by the equipment manufacturer, or abraded by approved mechanical means using sanding disks with appropriate abrasive, to thoroughly roughen the entire surface and produce a dense, consistent, sharp, angular, uniform anchor pattern with a profile height of 1.0-1.5 mils, exhibiting a uniform gray color free of any bright, shiny spangles and to an appearance and feel similar to sandpaper.
4. The required thickness of the zinc coating shall be maintained and checked prior to painting. Surface preparation shall be acceptable to the paint manufacturer's requirements. Additional surface preparation or a tie coat may be considered if required by the paint manufacturer and approved by the Department.
5. The substrate surface shall be dry and free from dust, dirt, oil, grease or other contaminants.

**3.2.3. Discontinuities.** All visually evident detrimental surface imperfections (e.g. flux inclusions, dross inclusions, oil) that are present on galvanized surfaces shall be cleaned, and any high spots, rough areas and edges, spikes, and sharp protrusions shall be removed by grinding to produce a smooth surface. Disbondment (peeling) of galvanizing is not acceptable and the piece shall be regalvanized, or investigated for extent and severity and a repair solution proposed to the Department for approval before corrective action is taken.

**3.2.4** Surface profiling shall be performed prior to the formation of “white rust” on the galvanized surface. If any “white rust” is detected by visual means, the galvanizing shall be stripped off and the steel re-galvanized in conformance with these specifications. “White rust” shall be as defined in the Inspection of Products Hot Dip Galvanized After Fabrication, Table IV, by the American Galvanizers Association.

**3.2.5** Prior to painting galvanized products shall not be nested, stacked or stored with adjacent surfaces touching but shall be kept separated to be remain dry and permit the circulation of air between products.

### 3.3 [Blank]

### 3.4 Paint Application.

**3.4.1 Time limits.** The first coat of paint shall be applied within twelve (12) hours of galvanizing and within one hour of surface preparation of the galvanized surface and outgassing, at the galvanizer’s facility, and in a controlled environment meeting applicable atmospheric requirements, as recommended by the coating manufacturer.

**3.4.2 Paint application.** Pretreatment and paint application and curing shall be performed after galvanizing in conformance with the paint manufacturer's recommendations and shall consist of the following, unless approved otherwise:

1. Verify that the galvanized surface exhibits the specified degree of cleaning immediately prior to painting.
2. The coating and curing facility shall be maintained free of airborne dust and dirt until coatings are completely cured.
3. Paint shall be applied according to the coating manufacturer's written specifications, maintaining even coverage on all parts. The paint shall only be applied when both the ambient temperature is 50° F. or above, and the part surface temperature is between 50° and 95° F., is 5° F. (min.) higher than the dew point, and the relative humidity is less than 85 percent (max.). For the SC moisture-cure urethane use 2° F dew point differential and 98% maximum R.H.
4. Only apply paint to surfaces that are thoroughly dry.
5. During cure, the paint coats shall be maintained in a protected environment within a min-max temperature range of 60-95°F for the duration of the cure-to-recoat cycle listed on the paint product data sheet, unless the paint manufacturer’s requirements are more restrictive.

## SECTION 708

6. Apply all coats by airless or conventional spray, unless other methods are necessary. If conventional spray is used, verify that the compressed air supply is clean and dry as determined by the blotter test in accordance with ASTM D 4285.
7. Apply each coat of paint only after the previous coat has been allowed to dry as required by the manufacturer's written instructions, but as soon as possible to minimize the length of time that the coating is exposed to dust and contamination. Do not allow any coat to remain exposed for longer than 14 days prior to overcoating.
8. Apply each coat in a workmanlike manner to assure thorough wetting of the substrate or underlying coat, and to achieve a smooth, streamline surface free of dryspray, overspray, and orange peel. Shadow-through, pinholes, bubbles, skips, misses, lap marks between applications, or other visible discontinuities in any coat are unacceptable. Runs or sags may be brushed out while the material remains wet.
9. Remove dryspray and overspray (e.g. by sanding) prior to the application of the next coat. When present on the finish, remove as directed by the Department and apply another coat of finish to the area. Remove all other defective coating to sound material and reapply.
10. Thoroughly coat all surfaces with special attention to hard-to-reach areas, and irregular surfaces. When coating configurations such as bolts, apply the material from multiple directions to assure complete coverage.
11. Apply all coats in such a manner to assure that they are well adhered to each other and to the substrate. If the application of any coat causes lifting of an underlying coat, or there is poor adhesion between coats or to the substrate, remove the coating in the affected area to adjacent sound, adherent coating, and reapply the material.
12. Use wet film thickness gages in conformance to ASTM D4414 to verify the thickness of each coat at the time of application.
13. Paint shall be applied to the minimum dry film thickness specified, and in a manner that will ensure a uniform coating without holidays, runs, or detrimental build at edges.
14. Each coated part shall be visually inspected. Measure the coating thickness with a thickness gauge. Any part that does meet the specified coating thickness may be recoated immediately after lightly abrading (sanding) the surface. All parts shall be allowed to cure sufficiently before further handling.

**3.4.3 Surface smoothness - Duplex coatings** shall exhibit a smoothness (i.e. rugosity) not greater than 4 rug (16-20 microns of variation) when measured by a profilometer over a 1-inch straight line on the surface of metal products less than 24 lbs/ linear foot. The profilometer shall be capable of operating in 1 micron increments.

**3.4.4 Hardware** shall be galvanized and fasteners exposed to view after installation shall receive the painted or powder coated duplex coating. Furnish an application procedure to the Department. Coating procedures for fasteners are not restricted to the same-facility (1.2) and 12-hour maximum window (3.4.1) restrictions, due to the different nature of fastener supply.

1. Bolts - Paint/powder coat bolt heads. Minor overspray is permitted on the threads.
2. Nuts - Paint/powder coat exterior nut surfaces and mask off interior surfaces.
3. Washers - Paint/powder coat all washer surfaces.

### 3.5 Inspection.

**3.5.1 Quality Control (QC).** The applicator is required to conduct and document quality control inspection of the cleaning and painting operations including at a minimum, measurements of surface profile, surface cleanliness, dry film coating thickness, and visual inspection for coating defects. The data shall be recorded in a log maintained at the site and available for the Department's review during working hours.

**3.5.2 Quality Assurance (QA).** The work is subject to QA inspection by the Department.

1. Facilitate QA inspection as required, including proper notification, allowing adequate time for inspections, and providing access to the work. Furnish, until final acceptance of the coating system, all equipment, reference documents, and instrumentation needed to inspect all phases of the work.
2. Measure the thickness of each coat using nondestructive magnetic dry film thickness gages. Comply with SSPC-PA2 for the calibration and use of gages and the minimum frequency of thickness measurements. QA Inspectors will not be limited by the frequency of thickness measurements of PA2 but will take measurements sufficient to assure that proper thickness is achieved on all surfaces as specified.
3. The presence or activity of Department QA inspections in no way relieves the Contractor of the responsibility to comply with all requirements of this Item, and to provide adequate inspections of its own to assure compliance with the requirements of this Item.
4. Finished products will be stamped "Approved" only after the loading has been completed and approved. No material shall be shipped without the prior approval of the Department.

### 3.6 Handling / Shipping / Installation.

**3.6.1.** Duplex-coated materials shall not be lifted, placed on supports, or loaded for shipment until the shop coating has been adequately cured and inspected.

**3.6.2. Protective measures.** Exercise care in handling shop-coated materials in the shop, and during storage, shipping, field installation, and subsequent construction to protect the coating from any scraping, marring, or other damage to the surface finish. Coated material shall be insulated from lifting devices and from the scraping and rubbing of parts that would damage the coating, by the use of lifting softeners, nylon slings, padded cables, storage pallets, separators, cushioners, tie-downs, and other approved supports. Individual parts shall be wrapped or padded with effective protective material (e.g. foam, not paper or cardboard).

**3.6.3. Installation.** Comply with fabricator's and galvanizer's requirements for installation of materials and fabrications, including use of nylon slings or padded cables for handling shop-coated materials.

### 3.7 Touch-Up and Repairs.

**3.7.1** The total repair area shall be less than one quarter of one percent ( 0.25% ) of the area of an individual member, or the member shall be rejected and regalvanized and recoated with the duplex coating. [The repair area definition is comparable to Rust Grade 7 in ASTM D610, *Standard Test Method for Evaluating Degree of Rusting on Painted Steel Surfaces.*]

**3.7.2 HDG-** Repair damaged galvanizing and bare steel surfaces in accordance with ASTM A780, Standard Practice for Repair of Damaged Hot Dipped Galvanized Coatings, Annex A2. Thoroughly clean damaged areas to produce a clean, bare and dry bright metal surface with a roughened profile and feather into the edges of adjacent undamaged galvanizing. Use a power sanding disk per SSPC-SP3. For bolts use a thorough hand wire brushing and SP1 cleaning as a minimum.

**3.7.3** Apply an approved organic zinc-rich repair paint containing 92 percent (min.) zinc by weight in the dry film, according to the manufacturer's recommendations, in two to four coats to a thickness equivalent to the surrounding galvanizing. Silver paint, brite paint, or aluminum paint is not acceptable.

**3.7.4 Paint -** The repair to the paint may be a liquid and brushed on or an aerosol and sprayed, whichever is appropriate to achieve an aesthetic finish and as long as the coats, cure, and minimum thickness of the original system are achieved. The Contractor shall provide a dry film thickness gage and check the thickness of the repair areas. Touch-ups shall be such that the repair is not noticeably visible from a distance of six feet.

1. The field-touch-up of shop-applied finish coatings shall be performed or supervised by personnel from the duplex coating facility for the warranty to apply.
2. Touch up fasteners in the field after installation, assuming there may be mechanical damage to nuts during tensioning fasteners.
3. Touch-up repair kits in sufficient quantity and touchup instructions shall be provided to the field for each type of shop-applied finish. Additional touchup repair kits and instructions shall be furnished to the Department for use after project acceptance for maintenance repairs.

### 3.8 Final Acceptance.

Although the Department's QA Inspector may accept the finished duplex coated fabricated products before shipment to the jobsite, final acceptance of the duplex coat system by the Department will occur at the jobsite after installation of the product, and after all coats and repairs have been completed.

### 3.9 Three-Year Warranty.

Should the duplex system fail within three years after the project has been accepted, the coating shall be repaired or replaced by the Contractor at no cost to the State. The extent and method of repair must be acceptable to the Department. System failure does not include damage from external agents, such as scraping from snow removal equipment, vandalism, debris impacts, collisions, etc., or normal loss of gloss and color. Once the duplex system has been accepted, a failure shall mean any visible corrosion, blistering, checking, cracking, or delamination (peeling) of the galvanizing or paint resulting from the installation of the product or from the performance of the duplex coating.

## APPENDIX B

## DUPLEX COATINGS - POWDER COATING OVER GALVANIZING

Highlight these requirements:

- Apply galvanizing and powder coating within the same facility (see 1.2);
- Apply first powder coating over galvanizing within a maximum 12-hour window (see 3.4.1).

## DESCRIPTION

**1.1 General.** This appendix specifies a duplex coating, consisting of hot dip galvanizing and high-performance, shop-applied, thermosetting-based, super-durable powder coatings, for fabricated steel products for exterior use, as shown on the plans or as directed.

**1.2 Duplex Coating Facility.** The galvanizer shall be qualified and have demonstrated a minimum of ten years' experience in the successful application of hot dip galvanizing using the dry kettle process, and a minimum of five years' experience in the successful application of powder coatings over galvanizing within the same facility.

**1.3 Scope Of Work.** All fabricated products and components, as shown on the plans or as directed, shall be furnished with a duplex coating color finish as described. See Summary Table 1.3.

## MATERIALS

**2.1 Galvanizing.** Hot dip galvanizing shall conform to AASHTO M111 (ASTM A123) and utilize the dry kettle process in a bath of molten zinc. The galvanizing kettle shall contain special high grade zinc, nickel, and other earthly materials. The galvanizing process shall not include quenching with water or treatment with a chromate conversion coating. Provide thickness of galvanizing specified in the reference standards. Hardware shall be hot dip galvanized in conformance with AASHTO M232 (ASTM A153).

**2.2 Abrasives.** Provide abrasives that are dry and free of oil, grease, and corrosion-producing, or other deleterious contaminants. Provide an abrasive that is sized to produce a dense, consistent, sharp, angular, uniform anchor pattern with a profile height of 1.0-1.5 mils, unless the requirements of the coating manufacturer are more restrictive. The use of iron shot, steel shot, aluminum oxide grit, sand, or coal slag products as blast abrasives, and power wire brushes are NOT permitted. Use approved abrasives [e.g. garnet, stainless steel grit, Dupont StarBlast® XL (fractured), etc.] that will not leave a residue on the galvanized surface after blowing down with compressed air.

**2.3 Powder Coating.** The duplex coating shall be a two-coat shop-applied, oven-cured, high performance, exterior thermosetting powder coating consisting of a durable zinc-rich powder coating primer, and a super-durable powder coating topcoat applied over hot dipped galvanized (HDG) steel substrates. For extra protection a third coat consisting of a powder clearcoat may be specified.

SCOPE OF WORK - SUMMARY TABLE 1.3

Treatment	Surfaces to be powder coated, as shown on the plans *	Duplex System (2.3)	Final Color (satin)
Standard (use u.n.o.)	<u>example:</u> Item 606.000, Steel Beam for Beam Guardrail	Hot Dip Galvanizing, plus durable powder primer, and super durable powder topcoat	Dark Brown u.n.o. Fed # 20062
Extra Protection	<u>example:</u> Item 563.5208, Bridge Pedestrian Rail (Galv-Powder Coated)	Hot Dip Galvanizing, plus durable powder primer, super durable powder topcoat, and powder clearcoat	Dark Brown u.n.o. Fed # 20062

\* Fasteners exposed to view after installation shall receive duplex coating per section 3.4.4 and 3.7.4.(2).

**2.3.1** Furnish powder coating materials from one of the following approved suppliers:

1. AkzoNobel
2. PPG
3. Sherwin Williams
4. TIGER Drylac

**2.3.2** The powder coating manufacturer shall certify in writing that:

1. The duplex coating facility applying the powder coating is certified to apply the powder by the coating manufacturer;

2. The powder coating meets or exceeds the following minimum performance requirements for use over hot dip galvanized surfaces:

**Powder Coating (min.) Performance Requirements**

Test	Powder Primer	Powder Topcoat
1. Thickness (SSPC PA2)	3 mils (min.)	5 mils (min.)
2. Adhesion (ASTM D4541)	1050 psi (min)	1050 psi (min)
3. Impact Resistance (ASTM D2794 Direct)	160" lbs.	160" lbs.
4. Flexibility (ASTM D522)	pass	pass
5. Pencil Hardness (ASTM D3363)	3B	2H
6. Humidity (ASTM D4585) 100° F, 2000 hrs	Pass, no cracking or delamination	Pass, no cracking or delamination
7. Corrosion Weathering (ASTM D5894, 13 cycles, 4000 hours)	blister rating: 10 rust rating: 7	---
8. Dry Heat Resistance (ASTM D2485)	250° F	---
9. Abrasion Resistance (ASTM D4060)	200 mg loss (max)	---
10. Salt Spray (ASTM B117) 2000 hrs	---	pass
11. Color Retention (ASTM D2244) 10 years	---	3ΔE (based on inorganic resins)
12. Chalk Resistance (ASTM D4214)	---	none
13. Gloss Retention (ASTM D523) 10 years	---	45% loss (max)
14. Xenon Arc Test (ASTM D 4798) 400 hrs	---	pass

**2.3.3** Provide each coat of powder coating in sufficiently contrasting color to facilitate proper coverage and to distinguish it from previously applied coatings. The previous coat shall be hidden by application of each coat at the specified minimum thickness.

**2.3.4** Provide all powder coating materials in sealed, original, containers that are properly marked to allow verification, with applicable material safety data sheets, application instructions and precautions, including the manufacturer's name, type of material, brand name, color, shelf life, purchase order number, lot and batch numbers, and quantity.

**2.3.5 Color.** The final color of the painted product shall be (see Table 1.3) (satin) unless specified otherwise, closely matching the Federal Standard 595B or RAL Color Standard number, as follows:

Description	Fed Color #
Dark Green	24109
Dark Brown	20062
Black	27038

**2.3.6 Touchup materials.** Repair and touch-up materials shall be supplied by the powder coating applicator and applied in accordance with the powder coating manufacturer's recommendations.

## 2.4 Equipment.

**2.4.1 Inspection Equipment.** Provide inspection equipment needed to verify the quality of the entire galvanizing, surface preparation, and powder coating processes, including a Type II dry film thickness gage that can be calibrated, calibration standards, and a mirror for use by the Department.

## Duplex Coatings - Powder Coating Over Galvanizing

### 3.1 General.

**3.1.1** Provide all materials, equipment, and labor necessary to perform the scope of work whether or not the material or equipment is specifically identified in this Item. Conduct all galvanizing, surface preparation, powder coating operations, handling, shipment, and installation in a workmanlike manner in conformance with SSPC-PA1, these requirements, and to the reasonable satisfaction of the Department.

## SECTION 708

### 3.1.2 Basis of Design. [blank]

**3.1.3 Specifications.** Perform the work in conformance to the Contract requirements, the reference standards, and the coating manufacturer's instructions, respectively.

**3.1.3.1 Reference Standards.** The latest edition of the following standards and regulations in effect at the time of the Bid form a part of this Specification. A copy of the reference standards applicable to the work shall be available at the shop facility for use by the Department's representative.

#### a. American Society for Testing and Materials (ASTM)

1. ASTM A123, Standard Specification for Zinc (Hot Dip Galvanized) Coatings on Iron and Steel Products
2. ASTM A153, Standard Specification for Zinc Coating (Hot Dip) on Iron and Steel Hardware
3. ASTM A385, Standard Practice for Providing High-Quality Zinc Coatings (Hot Dip)
4. ASTM A780, Standard Practice for Repair of Damaged and Uncoated Areas of Hot Dip Galvanized Coatings
5. ASTM D610, Standard Test Method for Evaluating Degree of Rusting on Painted Steel Surfaces
6. ASTM D6386, Standard Practice for Preparation of Zinc (Hot Dip Galvanized) Coated Iron and Steel Product and Hardware Surfaces for Painting.

#### b. American Association of State Highway & Transportation Officials (AASHTO)

1. AASHTO M111, Zinc (Hot Dip Galvanized) Coatings on Iron and Steel Products
2. AASHTO M232, Zinc Coating (Hot Dip) on Iron and Steel Hardware

#### c. American Galvanizers Association (AGA)

1. The Inspection of Products Hot Dip Galvanized After Fabrication
2. *Powder Coating over Hot Dip Galvanized Steel*, Powder Coating Journal, Feb 2004, Philip Rahrig, AGA Executive Director
3. *Powder Coating over Galvanized Steel*, Tom Langill, AGA Technical Director, Feb 2010.

#### d. Society for Protective Coatings (SSPC)

1. SSPC-SP 1, Solvent Cleaning
2. SSPC-SP 7 / NACE No. 4, Brush Off Blast Cleaning
3. SSPC-PA 1, Shop, Field, and Maintenance Painting
4. SSPC-PA 2, Measurement of Dry Film Thickness with Magnetic Gages

### 3.1.4 Submittals.

#### 3.1.4.1 Surface Preparation and Powder Coating Plan.

1. Provide a written plan to the Department for applying duplex coatings. Identify the manner of surface preparation, the powder coat system to be applied, film thickness, cure time between coats, repair materials and procedures of typical damage and defects in the duplex coating, and other information needed to successfully apply all coats of the duplex system.
2. Provide material product literature and MSD sheets for the coatings specified, along with test data indicating conformance to the performance criteria required.
3. Verification samples. Submit six 3-inch by 6-inch samples of shop-applied duplex coatings and colors proposed for use for approval to the Department (Bureau of Bridge Design, Tel. 603-271-2731) a minimum four weeks prior to coating application. Samples shall be made of the same or comparable material and thickness as production pieces.
4. Submit a Certificate of Compliance stating that the requirements of the contract specifications have been met, in conformance to [106.04](#).

#### 3.1.4.2 Substitutions or Approved Equals.

1. Substitutions or 'Approved Equals' are defined as meeting the aesthetic, durability, and all other performance criteria described in this specification, and shall be accompanied by proof that the Substitution or 'Approved Equal' meets or exceeds these criteria. Approval is the discretion of the Department. Coatings or processes not matching or exceeding the approved specified process and aesthetic, durability, and performance criteria shall be removed and replaced at the expense of the Contractor and all Subcontractors that were involved with the supply of and application of the non-conforming product.

### 3.1.5 Supplier Coordination.

1. **Fabricator-Galvanizer Coordination.** Prior to fabrication and final submittal of shop drawings to the Department, fabricators shall submit shop drawings to the galvanizer for all metal fabrications to receive shop-applied duplex coatings, to review fabricator's shop drawings for suitability of materials for galvanizing and coatings, and to coordinate any required modifications to fabrications required to be performed by the fabricator.
2. The supplier of steel products shall notify the galvanizer if the chemical composition of the steel to be galvanized exceeds the following limits in order to determine its suitability for processing: 0.25% carbon, 0.22% silicon, 0.04% phosphorous, and 1.3% manganese.

### 3.2 Hot Dip Galvanizing (HDG)

**3.2.1** Fabricated products shall meet the requirements of ASTM A385 (for material composition, cleanliness, drainage vents, etc.) prior to galvanizing, and galvanized surfaces shall meet the requirements of ASTM D6386 (preparing zinc surfaces for painting), as applicable and as stated herein.

1. Galvanizing: Galvanize materials in accordance with specified standards and this specification. Galvanizing shall provide an acceptable substrate for applied coatings. The dry kettle process shall be used to eliminate any flux inclusions on the surface of the galvanized material.
2. Prior to galvanizing, the steel shall be immersed in a preflux solution (zinc ammonium chloride). The preflux tank shall be 12-14 Baumé and contain less than 0.4 percent iron. The wet kettle process is prohibited.
3. Implement the following procedures to provide the appropriate surface for the material to be galvanized:
  - a) Utilize and regularly inspect a monitoring recorder to observe any variances in the galvanizing bath temperature.
  - b) The pickling tanks shall contain hydrochloric acid with an iron content less than 8 percent and zinc content less than 3 percent. Titrations shall be taken weekly at a minimum.
  - c) All chemicals and zinc content will be tested at least once a week to determine compliance with ASTM standards. All testing will be done using atomic absorption spectrometry or x-ray fluorescence (XRF) equipment at a lab in the galvanizing plant.

#### 3.2.2 Surface Preparation of Hot Dip Galvanizing (HDG)

1. Prepare all surfaces in conformance to the requirements of this Item, and the approved Surface Preparation/Powder coating Plan provided under 3.1.4, Submittals.
2. Prior to powder coating, clean and prepare galvanized surfaces as necessary to remove detrimental contaminants. (See *Powder Coating over Galvanized Steel*, Feb 2010 Tom Langill for cautions regarding cleaning.) If applicable apply cleaning materials with clean lint-free rags or soft bristle brushes frequently changed to prevent reapplying contaminants. After cleaning, rinse thoroughly with hot water and allow the part to dry completely.
3. Prepare galvanized surfaces with SSPC-SP7, Brush-Off Blast Cleaning, using non-metallic abrasives at a reduced nozzle pressure as recommended by the equipment manufacturer, or abraded by approved mechanical means using sanding disks with appropriate abrasive, to thoroughly roughen the entire surface and produce a dense, consistent, sharp, angular, uniform anchor pattern with a profile height of 1.0-1.5 mils, exhibiting a uniform gray color free of any bright, shiny spangles and to an appearance and feel similar to sandpaper.
4. The required thickness of the zinc coating shall be maintained and checked prior to powder coating. Surface preparation shall be acceptable to the powder coating manufacturer's requirements. Additional surface preparation or a tie coat may be considered if required by the powder coating manufacturer and approved by the Department.
5. The substrate surface shall be dry and free from dust, dirt, oil, grease or other contaminants.

**3.2.3 Discontinuities.** All visually evident detrimental surface imperfections (e.g. flux inclusions, dross inclusions, oil) that are present on galvanized surfaces shall be cleaned, and any high spots, rough areas and edges, spikes, and sharp protrusions shall be removed by grinding to produce a smooth surface. Disbondment (peeling) of galvanizing is not acceptable and the piece shall be regalvanized, or investigated for extent and severity and a repair solution proposed to the Department for approval before corrective action is taken.

**3.2.4** Surface profiling shall be performed prior to the formation of “white rust” on the galvanized surface. If any “white rust” is detected by visual means, the galvanizing shall be stripped off and the steel re-galvanized in conformance with these specifications. “White rust” shall be as defined in the Inspection of Products Hot Dip Galvanized After Fabrication, Table IV, by the American Galvanizers Association.

**3.2.5** Prior to powder coating galvanized products shall not be nested, stacked or stored with adjacent surfaces touching but shall be kept separated to remain dry and permit the circulation of air between products.

## SECTION 708

### 3.3 Galvanized Steel Outgassing.

**3.3.1** The galvanized parts shall be subjected to a thermal cycle (i.e. outgassing) after surface profiling and before powder coating application. The thermal cycle should be set at the appropriate temperature and duration for the thickness of the product recommended by the powder coating manufacturer.

### 3.4 Powder Coat Application.

**3.4.1 Time limits.** The first coat of powder coating shall be applied within twelve (12) hours of galvanizing and within one hour of surface preparation of the galvanized surface and outgassing, at the galvanizer's facility, and in a controlled environment meeting applicable atmospheric requirements, as recommended by the coating manufacturer.

**3.4.2 Powder coating application.** Pretreatment and powder coating application and curing shall be performed after galvanizing in conformance with the powder coating manufacturer's recommendations and shall consist of the following, unless approved otherwise:

1. Verify that the galvanized surface exhibits the specified degree of cleaning immediately prior to powder coating.
2. The coating and curing facility shall be maintained free of airborne dust and dirt until coatings are completely cured.
3. The powder coating shall be electrostatically applied according to the coating manufacturer's written specifications, maintaining even coverage on all parts. The powder shall only be applied when both the ambient temperature is 65° F. or above, and the part surface temperature is between 60° and 95° F., and is (min.) 5° F. higher than the dew point. Relative humidity shall be less than 85 percent (max.).
4. After applying the powder, all parts shall be placed in an oven, cured and bonded at the manufacturer's recommended levels (e.g. approximately 392° F. for 25 minutes). The Contractor shall ensure that a stable transfer exists between the powder application system and the curing oven to prevent the loss of powder from the parts.
5. The powder coating shall be applied to a minimum dry film thickness of 3 mils primer and 5 mils topcoat, and in a manner that will ensure a uniform coating without holidays, runs, or detrimental build at edges. A clear coat shall be applied at the manufacturer's recommended thickness.
6. Each coated part shall be visually inspected. Measure the coating thickness with a thickness gauge. Any part that does not meet the specified coating thickness may be recoated immediately after lightly abrading (sanding) the surface. Once cured, all parts shall be allowed to cool sufficiently before further handling.

**3.4.3 Surface smoothness - Duplex coatings** shall exhibit a smoothness (i.e. rugosity) not greater than 4 rug (16-20 microns of variation) when measured by a profilometer over a 1-inch straight line on the surface of metal products less than 24 lbs/ linear foot. The profilometer shall be capable of operating in 1 micron increments.

**3.4.4 Hardware** shall be galvanized and powder coated as follows. Furnish an application procedure to the Department. Coating procedures for fasteners are not restricted to the same-facility (1.2) and 12-hour maximum window (3.3.1) restrictions, due to the different nature of fastener supply.

1. Bolts - Powder coat bolt heads. Minor overspray is permitted on the threads.
2. Nuts - Powder coat exterior nut surfaces and mask off interior surfaces.
3. Washers - Powder coat all washer surfaces.

### 3.5 Inspection.

**3.5.1 Quality Control (QC).** The applicator is required to conduct and document quality control inspection of the cleaning and powder coating operations including at a minimum, measurements of surface profile, surface cleanliness, dry film coating thickness, and visual inspection for coating defects. The data shall be recorded in a log maintained at the site and available for the Department's review during working hours.

**3.5.2 Quality Assurance (QA).** The work is subject to QA inspection by the Department.

1. Facilitate QA inspection as required, including proper notification, allowing adequate time for inspections, and providing access to the work. Furnish, until final acceptance of the coating system, all equipment, reference documents, and instrumentation needed to inspect all phases of the work.
2. Measure the thickness of each coat using nondestructive magnetic dry film thickness gages. Comply with SSPC-PA2 for the calibration and use of gages and the minimum frequency of thickness measurements. QA Inspectors will not be limited by the frequency of thickness measurements of PA2 but will take measurements sufficient to assure that proper thickness is achieved on all surfaces as specified.



3. The presence or activity of Department QA inspections in no way relieves the Contractor of the responsibility to comply with all requirements of this Item, and to provide adequate inspections of its own to assure compliance with the requirements of this Item.
4. Finished products will be stamped “Approved” only after the loading has been completed and approved. No material shall be shipped without the prior approval of the Department.

### 3.6 Handling / Shipping / Installation.

**3.6.1.** Duplex-coated materials shall not be lifted, placed on supports, or loaded for shipment until the shop coating has been adequately cured and inspected.

**3.6.2. Protective measures.** Exercise care in handling shop-coated materials in the shop, and during storage, shipping, field installation, and subsequent construction to protect the coating from any scraping, marring, or other damage to the surface finish. Coated material shall be insulated from lifting devices and from the scraping and rubbing of parts that would damage the coating, by the use of lifting softeners, nylon slings, padded cables, storage pallets, separators, cushioners, tie-downs, and other approved supports. Individual parts shall be wrapped or padded with effective protective material (e.g. foam, not paper or cardboard).

**3.6.3. Installation.** Comply with fabricator's and galvanizer's requirements for installation of materials and fabrications, including use of nylon slings or padded cables for handling shop-coated materials.

### 3.7 Touch-Up And Repairs.

**3.7.1** The total repair area shall be less than one quarter of one percent ( 0.25% ) of the area of an individual member, or the member shall be rejected and regalvanized and recoated with the duplex coating. [The repair area definition is comparable to Rust Grade 7 in ASTM D610, *Standard Test Method for Evaluating Degree of Rusting on Painted Steel Surfaces.*]

**3.7.2 HDG-** Repair damaged galvanizing and bare steel surfaces in accordance with ASTM A780, Standard Practice for Repair of Damaged Hot Dipped Galvanized Coatings, Annex A2. Thoroughly clean damaged areas to produce a clean, bare and dry bright metal surface with a roughened profile and feather into the edges of adjacent undamaged galvanizing. Use a power sanding disk per SSPC-SP3. For bolts use a thorough hand wire brushing and SP1 cleaning as a minimum.

**3.7.3** Apply an approved organic zinc-rich repair paint containing 92 percent (min.) zinc by weight in the dry film, according to the manufacturer's recommendations, in two to four coats to a thickness equivalent to the surrounding galvanizing. Silver paint, brite paint, or aluminum paint is not acceptable.

**3.7.4** Powder coating - The repair to the powder coat may be a liquid and brushed on or an aerosol and sprayed, whichever is appropriate to achieve an aesthetic finish and as long as the coats, cure, and minimum thickness of the original system are achieved. The Contractor shall provide a dry film thickness gage and check the thickness of the repair areas. Touch-ups shall be such that the repair is not noticeably visible from a distance of six feet.

1. The field-touch-up of shop-applied finish coatings shall be performed or supervised by personnel from the duplex coating facility for the warranty to apply.
2. Touch up fasteners in the field after installation, assuming there may be mechanical damage to nuts during tensioning fasteners.
3. Touch-up repair kits in sufficient quantity and touchup instructions shall be provided to the field for each type of shop-applied finish. Additional touchup repair kits and instructions shall be furnished to the Department for use after project acceptance for maintenance repairs.

### 3.8 Final Acceptance.

Although the Department's QA Inspector may accept the finished duplex coated fabricated products before shipment to the jobsite, final acceptance of the duplex coat system by the Department will occur at the jobsite after installation of the product, and after all coats and repairs have been completed.

### 3.9 Five-Year Warranty.

Should the duplex system fail within five years after the project has been accepted, the coating shall be repaired or replaced by the Contractor at no cost to the State. The extent and method of repair must be acceptable to the Department. System failure does not include damage from external agents, such as scraping from snow removal equipment, vandalism, debris impacts, collisions, etc., or normal loss of gloss and color. Once the duplex system has been accepted, a failure shall mean any visible corrosion, blistering, checking, cracking, or delamination (peeling) of the galvanizing or powder coating resulting from the installation of the product or from the performance of the duplex coating.

## APPENDIX C

**DUPLEX COATINGS - METALLIZING AND SEALER**  
**DUPLEX COATINGS - METALLIZING AND PAINT**

This Appendix amends the Special Provision for Section 550, Structural Steel, (Spec Prov 550) and specifies a duplex coating, consisting of metallizing and sealer, or metallizing, sealer, and paint for a color finish, for fabricated structural steel components, as shown on the plans or as directed. The requirements of Spec Prov 550 apply, except as modified herein. Use of the term *Thermal Spray Coating (TSC)* is intended to mean the same as, and to be used interchangeably with, the term *metallizing*.

Point of Emphasis:

- Blast steel, and apply metallizing and sealer/paint, within the same facility (see 1.2)
- Apply metallizing to steel surface within six hours (max.) after blasting (see 3.3.4.2)
- Apply sealer coat to metallizing within eight hours (max.) after metallizing (see 3.4.2)

**DESCRIPTION**

**1.1 GENERAL.** The work to apply a metallizing duplex coating shall meet the requirements of the Joint Standard, SSPC CS 23.00/ AWS C2.23/ NACE No. 12, Specification for the Application of Thermal Spray Coatings (Metallizing), and the applicable requirements of Spec Prov 550 as modified herein. (Joint Standard references herein are abbreviated, e.g. JS 6.1).

**1.2 DUPLEX COATING FACILITY.** The facility performing the work shall be qualified (3.1.2) and have demonstrated a minimum of five years' experience within the same facility in successful surface preparation and the application of thermal spray coatings (TSC) over blasted steel surfaces, and application of a sealer/paint over TSC.

**1.3 SCOPE OF WORK.** See Spec Prov 550 Scope of Work Summary Table 1.3 for the specific structural steel components and duplex coating(s) required. Furnish structural steel components complete in place and accepted, using approved TSC materials, equipment, and procedures by qualified applicators.

**MATERIALS**

**2.1 ABRASIVES.** Provide a 100% steel grit abrasive sized to prepare steel surfaces to an SSPC-SP5 White Metal Blast condition, and produce a dense, uniform, sharp, angular anchor pattern with a profile height of 3-5 mils, unless the requirements of the TSC manufacturer are more restrictive, and having hardness of 50 Rockwell C or higher. Shot is not permitted even if mixed with angular grit abrasive.

**2.2 METALLIZING.** The TSC material shall conform to Joint Standard Sect 6 and the following:

1. Apply TSC by the electric arc thermal spray metallizing process;
2. Use 99.9% Zinc wire manufactured per ASTM B 833 or AWS C2.25;
3. Use wire Classification W-Zn-1; UNS No. Z13005; max. lead .003, with low lead potential (less than 100 ppm);
4. Apply TSC at a min. target average thickness of 10 mils, within +/- 2 mil application range;
5. TSC to have less than 10% porosity;
6. TSC to have less than 4 mils surface roughness.

**2.2.1 Slip B Coefficient Testing** - The TSC shall meet Slip Coefficient requirements for Class B, per the RCSC specification for Structural Joints Using High Strength Bolts, Appendix A, required to apply to slip-critical bolted connections. See 3.6, Bolted Connections.

**2.2.2 Porosity** - The TSC Applicator shall demonstrate by means of metallographic examination per ASTM E2109, that the mean average area of porosity in the TSC is less than 10%. (JS Table 1, Footnote F).

**2.3 CLEAR SEALER.** All TSC zinc coated surfaces (except bolted faying surfaces) shall receive one coat of clear sealer at 1.5-2 mils DFT, thinned per manufacturer's instructions, with the intent of sealing porosity in the TSC, reducing zinc oxide staining, and improving adhesion of the TSC to the steel substrate. This sealer coat is not interpreted as providing barrier protection.

**2.3.1** The duplex system (TSC/Sealer) shall consist of the following type and coating thicknesses:

Coating	Description	Thickness (mils DFT)
Primer:	Thermal Spray Coating (metallizing)	10 mils target $\pm$ 2
Clear Sealer	Carboline Carbothane 134 Clear Coat, or as recommended by coating manufacturer	1.5-2 mils DFT

**2.4 PAINT SYSTEM.** When a color finish is desired and specified, the duplex coating shall include a two-coat shop-applied, high-performance, paint system consisting of an intermediate and top coat applied over the TSC and sealer coat.

**2.4.1** Furnish the intermediate and finish coat paint materials from Paint System A, B, or C in Spec Prov 550, or from Paint System List A or B in the current NEPCOAT Qualified Products List, and as recommended by the Coating Manufacturer.

**2.4.2** The duplex system (TSC/Sealer/Paint) shall consist of the following type and coating thicknesses:

Coating	Description	Thickness
Primer:	Thermal Spray Coating (metallizing)	10 mils target $\pm$ 2
Sealer	As recommended by coating manufacturer	1.5-2 mils DFT
Intermediate	High build epoxy polyamide, or Single-component moisture-cure polyurethane w/ MIO	4-6 mils DFT
Finish	Aliphatic polyurethane, or Single-component moisture-cure aliphatic polyurethane	2-4 mils DFT

**2.4.3 Color.** The final color of paint, if required, shall be as specified in Spec Prov 550 Table 1.3, closely matching the Federal Standard 595B, as follows:

Description	Federal Color #
DARK BROWN	20062
LIGHT GRAY (to match TSC)	26373

**2.4.4 Touchup materials.** Repair and touch-up materials for TSC, sealer coat, and paint shall be supplied by the paint applicator and applied in accordance with the paint manufacturer's recommendations.

**2.5 GALVANIZING.** Structural fasteners (i.e. bolts) will not be coated with TSC but shall be coated in accordance with ASTM B695 Class 50 for mechanically-deposited galvanizing.

**2.6 EQUIPMENT.** In addition to inspection equipment listed in Spec Prov 550 Sect. 2.6, provide a Surface Profile Comparator.

### DUPLIX COATINGS - METALLIZING AND SEALER DUPLIX COATINGS - METALLIZING AND PAINT

#### 3.1 GENERAL

**3.1.1** Provide all materials, equipment, and labor necessary to perform the scope of work whether or not the material or equipment is specifically identified in this Item. Conduct all surface preparation, metallizing, sealer and paint application operations, handling, shipment, and installation in a workmanlike manner in conformance with the Joint Standard (SSPC CS 23.00, AWS C2.23, NACE No. 12), the requirements of Spec Prov 550, this Appendix, the coating manufacturer's instructions, and to the reasonable satisfaction of the Department.

1. Summary of Practice. (JS Section 4, and Table 1)

## SECTION 708

### 3.1.2 Facility and Personnel Qualification.

1. The TSC Applicator Facility shall be qualified to SSPC-QP6, Contractor Metallizing Certification Program, or demonstrate a comparable level of approved qualification, having five years (min.) experience, having completed at least three projects on structures with TSC, sealer, and paint, and including at least one bridge. Supplement lack of experience as required with subcontracted on-site TSC expertise.
2. Furnish a list of work history of completed projects with client contacts.
3. Abrasive blasting Operators shall have a minimum of 6 months experience.
4. TSC Operators shall have a minimum of 6 months experience on bridges,
5. Blasting Supervisors and TSC Supervisors shall have a minimum of 1 year experience;
6. Field application shall meet the same or comparable requirements as for shop application.

#### 3.1.2.1 Sub-Contractors.

1. Work shall not be sub-contracted to another facility without prior Department approval. An approved sub-Contractor shall meet qualification requirements, comply with the same requirements, standards, specifications, use the same materials, and use the same or comparable equipment as the approved Facility.

**3.1.3 Reference Standards.** The latest edition of the applicable standards of Special Provision 550, and the following standards and regulations in effect at the time of the Bid form a part of this Specification. A copy of the reference standards applicable to the work shall be available at the shop facility for use by the Department's representative. (JS Section 2)

1. American Society for Testing and Materials (ASTM)
  - a. ASTM A153, Standard Specification for Zinc Coating (Hot Dip) on Iron and Steel Hardware
  - b. ASTM B833, Standard Specification for Zinc and Zinc Alloy Wire for TSC
  - c. ASTM D4228, Qualification for Applicators of Coatings
  - d. ASTM E3, Standard Practice for Preparation of Metallographic Specimens
  - e. ASTM E2109, Test Methods for Determining Area Percentage Porosity in TSC
2. American Welding Society (AWS)
  - a. AWS C2.16, Guide for TSC Operator Qualification (2002)
  - b. AWS C2.18, Guide for the Protection of Steel with TSC of Zn;
  - c. AWS C2.25, Specification for Solid and Composite Wires for TSC;
3. Society for Protective Coatings (SSPC)
  - a. SSPC-CS 23 / AWS C2.23 / NACE No. 12, Specification for the Application of Thermal Spray Coatings (Metallizing) of Aluminum, Zinc, and Their Alloys and Composites for the Corrosion Protection of Steel, July 2003 edition),
  - b. SSPC-SP 5, White Metal Blast Cleaning
  - c. VIS 1, Guide and Visual Reference Photographs for Steel Surfaces Prepared by Dry Abrasive Blast Cleaning

#### 3.1.4 Submittals.

##### 3.1.4.1 Surface Preparation/Coating Plan.

1. Provide a written plan to the Department for applying duplex coatings. Submit detailed procedures for surface preparation, TSC application, sealer/paint application, and in-process quality control, job control record, equipment, materials, and repair procedures, etc. for work in the shop and field.
2. Identify the coating materials to be applied and furnish Product Data sheets and MSD sheets.
3. Submit required verification documents and certificates to the Department (Joint Standard, Table 1 Footnote B).

4. Verification samples. Submit two 3-inch by 6-inch samples of all required shop-applied duplex coatings and colors proposed for use, for approval to the Department (Bureau of Bridge Design, Tel. 603-271-2731) a minimum two weeks prior to coating application. Samples shall be made of the same or comparable material and of a thickness sufficient to represent the process.
5. Submit a Certificate of Compliance stating that the requirements of the contract specifications have been met, in conformance to 106.04.
6. Substitutions or 'Approved Equals' are defined as meeting the aesthetic, durability, and performance criteria referenced in this specification, and shall demonstrate by documentation that the Substitution or 'Approved Equal' meets or exceeds these criteria. Approval is at the discretion of the Department. Coatings or processes not matching or exceeding the approved specified process and aesthetic, durability, and performance criteria shall be removed and replaced at the expense of the Contractor and all Subcontractors that were involved with the supply of and application of the non-conforming material.

### 3.2 STEEL SURFACE PREPARATION REQUIREMENTS.

#### 3.2.1 Surface Preparation.

1. Blasting steel surfaces and surface preparation shall conform to Joint Standard Section 5.
2. Prepare the steel substrate to an SSPC-SP 5 White Metal finish. Confirm with SSPC VIS 1.
3. All flame cut edges of structural steel shall be conditioned with light grinding prior to blasting to remove the hardened flame-cut surface in order to achieve the desired blast profile. Corners shall be blunted by grinding to a beveled edge.
4. Blast by hand-held open nozzle methods rather than automatic centrifugal wheels, unless approved otherwise.
5. The steel substrate shall have a sharp angular dense profile with a 3-5 mil profile depth using 100% sharp angular grit. Shot is not permitted even if mixed with angular grit abrasive. The Joint Standard indicates blasting media and mesh size found suitable for TSC on steel substrates. (JS Table 2).
6. The blast profile shall be measured using replica tape (X-course) according to the following minimum frequency for manual blasting: take one profile depth measurement for every 10-20 ft<sup>2</sup> of blasted surface. Check the profile density with a Surface Profile Comparator. (JS 6.3)
7. A complete visual examination of the blasted surface shall be performed by QC/QA Inspection.
8. Check the blasted steel surface for chloride contamination to condition SC2, per SSPC-SP12, at a random frequency (e.g. twice per project), using the Chlor\*Test™ as manufactured by Chlor\*Rid International Inc. (Tel. 800-422-3217).

### 3.3 METALLIZING APPLICATION

#### 3.3.1 Job Reference Standard (JRS) pre-production test plate

1. Metallizing materials and application shall conform to the Joint Standard.
2. Prepare a pre-production Job Reference Standard (JRS) plate in the presence of a Department representative. The JRS shall be used as a “comparator” to evaluate the suitability of the application process. (JS 3.9, 13.2)
2. The JRS shall be made on a steel plate with minimum dimensions of 18” x18” x1/4” using the same Thermal Spray Coating (TSC) equipment, process parameters, and procedures, and under the same environmental conditions, to be used in production. (JS 13.2)
3. Record the environmental conditions, process parameters, surface profile measurement results, TSC DFT. readings, TSC adhesion test results (per ASTM D4541), and sealer/paint application parameters.

## SECTION 708

4. The TSC DFT. readings and adhesion tests for the JRS shall be performed according to Joint Standard Fig. 5.
5. A metallographic examination shall be performed on the JRS plate (or companion plate) to quantify the mean average of the area of porosity in the TSC (JS Table 1 Footnote F). The Applicator Facility may use results from previous testing using the same TSC materials and equipment operating parameters.
6. If automatic blasting is proposed, it may be considered with an open nozzle blast finish. The suitability of the profile with 100% grit for automatic blasting shall be confirmed with a metallographic examination per ASTM E 3 and ASTM E 2109 (JS Table 1 Footnote F).
7. The JRS is to be used as a pass/fail reference for the applicator's in-process QC and the Owner's representative.
8. The TSC equipment for production work shall be set up per the coating manufacturer's instructions and according to the parameters used and documented while preparing the JRS plate. QC and QA shall verify that the proper parameters are used. (JS 13.2)

**3.3.2 Production Bend Test Coupons.** Five bend test coupons shall be prepared per each TSC operator, once at the start of each shift, prior to applying the TSC to the production pieces. Bend tests are performed on coupons without a sealer coat. (JS 6.5)

1. Use a mandrel diameter for the TSC thickness required (JS Table 4).
2. The bend tests shall be witnessed by QC and QA.
3. No cracking or spalling of TSC is permitted on a bend coupon. The test passes if there is only minor cracking that cannot be lifted from the substrate with a knife blade. (JS 3.2, 6.5)
4. If any one of the bend tests fails, the operator shall check the equipment for errors in set-up with QC participation, and re-make five additional bend coupons for testing. All five coupons must pass the bend test before production work may begin.

**3.3.3 Production Companion Plates.** A "companion plate" shall be blast cleaned to the proper finish at the same time as the production piece being metallized. One companion plate shall be prepared, metallized, and tested for every 500 ft<sup>2</sup> surface area of production pieces being metallized. (JS 3.4)

1. Apply TSC using the same spray patterns as on the production piece. (JS D6)
2. QC shall verify the TSC DFT. thickness on the companion plate.
3. QC shall perform adhesion testing per ASTM D4541 on the companion plate and document that the minimum required pull-off adhesion strength is observed. This value shall be based on the average of three adhesion tests for each companion plate.
4. The required minimum pull-off adhesion strength is 500 psi (JS Table 3).
5. A cut-test shall be used once per companion plate to test adhesion prior to the application of the sealer coat. A sharp chisel and hammer shall be used to strike and "cut" the TSC coating at a shallow angle. No peeling or delamination of the TSC is permitted. (JS 3.6)
6. All destructive (e.g. adhesion and cut) tests performed on the Companion Plate shall pass. If any of the tests fail, the 500 ft<sup>2</sup> of TSC applied on the production piece shall be removed and re-applied. (JS 6.4.1.2 and 6.5)

**3.3.4 Production TSC Application**

1. The steel surface temperature shall be at least 5° above the dew point of the ambient air temperature, and between 50 and 100 deg F. (JS 7.3.1)
2. The time between the completion of the blasting operation and the completion of the TSC application operation shall be no longer than six hours. (JS 7.3.2.1)

- a. Handlers involved in any part of the TSC process shall wear gloves that are clean and will not transmit any contamination to the steel.
  - b. If the production pieces being metallized are too large for completion of the TSC application within six hours of the completion of the blasting operation:
    - (1) One option is to use a 1-2 mil “ flash coat” of the TSC which may be applied within six hours of surface preparation to extend the hold time four hours, giving the piece a total time of 10 hours within which final TSC application must be finished, provided the surface can be maintained free of contaminants. Validate the use of the flash coat with additional adhesion and bend tests as described. (JS 7.4.1.1)
    - (2) Another option is to use a “ brush blast” to “ freshen” up the White Metal blast profile using suitably-sized Sponge Jet® abrasive media. [This option is outside the Joint Standard but may be approved with validation of the procedure per 7.4.2 furnishing an additional companion plate and bend coupons and testing.]
  - c. “ Brush blasting” of the steel surface with steel grit is the preferred method to ensure that no rust bloom occurs. QC shall perform a complete visual examination of the “ brush blast” for evidence of rust bloom or TSC degradation.
3. Apply TSC in a cross-hatch pattern (i.e. second set of passes at 90 degrees to the first set) to the specified coating thickness, to ensure the proper coating thickness, thorough coverage, and adhesion strength to the steel substrate. (JS 8.2.1)
    - a. The TSC gun shall be held at an offset distance so the metal is still molten on impact. (JS Table D1)
    - b. QC shall use a calibrated SSPC-PA 2, Type 2 electronic fixed probe gauge to measure the TSC thickness. (JS 6.1.3 and 6.2)
    - c. For flat surfaces, use the five-in-line method to take DFT. measurements (JS Fig. 3).
    - d. For complex geometries, use spot measurement (JS 6.3.2 and Fig. 3).
    - e. One five-in-line or spot measurement shall be taken per every 100-200 ft<sup>2</sup> of TSC applied. (JS 6.3.4)
  4. If the TSC DFT. thickness is too low, apply additional TSC to the production piece. (JS 6.2.1)
  5. If the TSC DFT. thickness is above 150% more than specified, this area shall be documented and supplied to the owner. If any damage of this area occurs during shipment or erection, the TSC Facility shall be liable for the repair costs. Repair to this area may be made prior to shipment. (JS 6.2.2)
  6. A complete visual examination of the TSC surface shall be performed by QC and QA. The TSC shall be uniform, without blisters, cracks, loose particles, or exposed steel examined under 10x magnification. (JS 6.6)

### 3.4 SEALER APPLICATION.

1. Apply the sealer according to the coating manufacturer’s recommendations and the Joint Standard Section 9 and D8.
2. Apply the sealer as soon as possible and within 8 hours of the completion of the TSC coating application. (JS 9.2.2)
3. Check the TSC surface for contamination and clean as required. (JS 9.2.3)
4. The thickness of the sealer coat, 1.5-2 mils DFT, is anticipated to be less than the surface roughness of the TSC and, therefore, the dry film thickness cannot be measured directly. Demonstrate by some means or procedure that the minimum sealer thickness is achieved. It is recommended that the wet film thickness (WFT) of the sealer be measured on a piece of plastic or cardboard at 4 mils WFT, and then use the same parameters and spray techniques to apply the sealer to the TSC on the production work piece to ensure proper coverage of the sealer.

## SECTION 708

5. Note: It may be necessary to apply the clear sealer coat in a two-step process. First apply a “mist coat” that is thinned at the maximum allowable thinning rate as listed on the product data sheet. The intent of the mist coat is to saturate the porous TSC surface and displace entrapped air within the porosity of the TSC. After allowing the mist coat to flash off for 20 minutes, apply a second full coat of clear sealer to achieve the intended total thickness.

### 3.5 PAINT APPLICATION

**3.5.1 Paint application.** The duplex coating consists of TSC and sealer coat plus a two-coat paint system. Surface preparation, i.e. retreatment if required, and paint application and curing shall be performed after the TSC and sealer are applied, in conformance with the Spec Prov 550 Sections 3.3 and 3.4, the paint manufacturer's recommendations and shall consist of the following, unless approved otherwise (JS 9.1.2):

7. Verify that the TSC surface exhibits the specified degree of cleanliness immediately prior to painting. The coating and curing facility shall be maintained free of airborne dust and dirt until coatings are completely cured.
8. Paint shall be applied according to the coating manufacturer's written specifications, maintaining even coverage on all parts. The paint shall only be applied when both the ambient temperature is 50° F. or above, and the part surface temperature is between 50° and 95° F., is 5° F. (min.) higher than the dew point, and the relative humidity (RH) is less than 85 percent (max.). For the SC moisture-cure urethane use 2° F (min.) dew point differential and 98% maximum RH.

**3.5.2** Faster hardware (i.e. bolts) shall be galvanized and fasteners exposed to view after installation shall be painted for a color match with the intermediate and finish coats of the approved paint system. Furnish an application procedure to the Department. Coating procedures for fasteners are not restricted to the same-facility (1.2) due to the different nature of fastener supply.

### 3.6 BOLTED CONNECTIONS

#### 3.6.1 Bolted Connections

1. Within 3” of bolt holes, faying surfaces (i.e. inside of connecting plates) shall receive a maximum of 10 mils TSC for 99.9% Zinc.
2. Do not apply the sealer coat to interior faying surfaces of bolt-connected plates.
3. The outer surfaces of bolted connection plates are to receive the same coating as adjacent structural steel for consistency of appearance with adjacent steel surfaces.
4. All bolted splice plates shall have sealer coat applied in manner that ensures that the sealer is on the outside surfaces only.

### 3.7 HANDLING / SHIPPING / INSTALLATION

1. Duplex-coated materials shall not be lifted, placed on supports, or loaded for shipment until the shop coating has been adequately cured and inspected.
2. Exercise care while handling coated steel members not to damage the coating, whether in the shop, during shipping, field erection, or subsequent construction of the bridge. Coated steel shall be insulated from lifting devices and from the scraping and rubbing of parts that would damage the coating by the use of lifting softeners, nylon slings, storage pallets, separators, cushions, tie-downs, and other approved supports.
3. The fabricator shall be responsible for the condition of the coating until the structural members arrive at the jobsite.
4. The General Contractor shall exercise the same degree of care during field operations as was required in the shop and during shipping to protect the coating, as described above.



### 3.8 TOUCH-UP AND REPAIRS

#### 3.8.1 General

1. The General Contractor is responsible for field touchups, repairs, etc. using the same level of quality in the field as in the shop for equipment, procedures, personnel, supervision, and inspection until final acceptance of the work.
2. Furnish a Field Repair Plan of damaged TSC conforming to AWS C2.18. (JS 6.2.2).
3. Repairs to damaged TSC areas four square inches or less may be made with an approved paint system following approved surface preparation.
4. Repairs to damaged TSC areas greater than four square inches shall be made by metallizing following approved surface preparation.

**3.8.2** Apply an approved organic zinc-rich repair paint containing 92 percent (min.) zinc by weight in the dry film, according to the manufacturer's recommendations, in multiple coats as required to achieve a thickness equivalent to the surrounding TSC. Silver paint, bright paint, or aluminum paint is not permitted.

**3.8.3** Paint - The repair to damaged paint shall be a liquid and brushed on to achieve an aesthetic finish and minimum thickness of the original system. The Contractor shall provide a dry film thickness gage and check the thickness of the repair areas. Touch-ups shall be such that the repair is not noticeably visible from a distance of six feet.

1. The field-touch-up of shop-applied finish coatings shall be performed or supervised by personnel from the duplex coating facility, or approved SSPC QP2 applicator, for the warranty to be accepted.
2. Touch up fasteners in the field after installation, assuming there may be mechanical damage to nuts when tensioning fasteners.
3. Furnish touch-up repair kits in sufficient quantity with instructions to the field for each type of shop-applied finish.

**3.9 FINAL ACCEPTANCE.** Although the Department's QA Inspector may accept the finished duplex coated fabricated products before shipment to the jobsite, final acceptance of the duplex coat system will occur at the jobsite by the Department after installation of the product, and after all coats and repairs have been completed.

**3.10 THREE-YEAR WARRANTY.** Should the duplex system fail within three years after the project has been accepted, the coating shall be repaired or replaced by the Contractor at no cost to the State. The extent and method of repair must be acceptable to the Department. System failure does not include damage from external agents, such as scraping from snow removal equipment, vandalism, debris impacts, collisions, etc., or normal loss of gloss and color. Once the duplex system has been accepted, a failure shall mean any visible corrosion, blistering, checking, cracking, or delamination (peeling) of the TSC or paint resulting from the installation of the product or from the performance of the duplex coating.

**SECTION 716 -- WELDING OF  
ALUMINUM ALLOYS FOR HIGHWAY STRUCTURES**

**General**

**1.1 Description.** These specifications apply to the welding of aluminum alloys used in bridge railing, structural supports for highway signs, luminaires, traffic signals, and the like.

**1.2 Specifications.**

**1.2.1** The welding terms used in these specifications shall be interpreted in accordance with the definitions given in the latest edition of Welding Terms and Definitions, ANSI/AWS A3.0.

**1.2.2** The welding symbols used on the plans will be those shown in the latest edition of Symbols for Welding, Brazing and Nondestructive Examination, ANSI/AWS A2.4. Special conditions will be fully explained by added notes or details.

**1.2.3** The welding of aluminum bridge railing shall conform to Section 10 of the ANSI/AWS D1.2 “Structural Welding Code – Aluminum” including Part E “Workmanship Class II Structures”. The fabrication and erection of bridge railing shall conform to Section 6 of the Specifications for Aluminum Structures, published by the Aluminum Association.

**1.2.4** The welding of aluminum sign supports, luminaires, and traffic signals shall conform to Section 10 of the ANSI/AWS D1.2 “Structural Welding Code – Aluminum” including Part D “Workmanship Class I Structures”. The fabrication and erection of aluminum sign supports, luminaires, and traffic signals shall conform to the requirements of the AASHTO Standard Specifications for Structural Supports for Highway Signs, Luminaires and Traffic Signals. Special consideration may be given to certain support structures, which may be fabricated according to the provisions of 1.2.3.

**Base Metals**

**2.1** The aluminum alloys to be welded under these specifications may be any of the following alloy designations:

Wrought non-heat-treatable alloys

Alloy 3003  
Alloy 3004  
Alloy 5052  
Alloy 5083  
Alloy 5086  
Alloy 5456

Wrought heat-treatable alloys

Alloy 6061  
Alloy 6063

Cast heat-treatable alloy

Alloy 356.0

**2.2** Material used for permanent backing shall be at least equivalent in weldability to the base metal being welded.

**Welding Processes.**

**3.1** These specifications include provisions for welding by the gas metal-arc process and the gas tungsten-arc process. Other processes may not be used except as permitted.

**Filler Metal.**

**4.1** Bare wire electrodes for use with the gas metal-arc process and welding rods for use with the gas tungsten-arc process shall conform to the requirements of the latest edition of Specification for Bare Aluminum and Aluminum Alloy, Welding Electrodes and Rods, ANSI/AWS A5.10.

**4.2** Tungsten electrodes for the gas tungsten-arc process shall conform to the requirements of the latest edition of Specification for Tungsten and Tungsten Alloy Electrodes for Arc Welding, ANSI/AWS A5.12.

**4.3** Filler metals to be used with particular base metals shall be as shown in Table 1. Other filler metals may be used as approved.

**Table 1 - Filler Metal Guide for Gas Shielded Arc Welding**

<b>Base Metals</b>	<b>Filler Metal</b>
3003 to 3003	ER1100
3004 to 3004	ER4043
5052 to 5052	ER5654*
5083 to 5083	ER5183*
5086 to 5086	ER5356*
5456 to 5456	ER5556*
6061 to 6061	ER4043*
6063 to 6063	ER5356*
356.0 to 6061	ER4043
356.0 to 6063	ER4043

\* ER5183, ER5356, and ER5556 may be used interchangeably for these base metals.

**4.4** Filler metals shall be kept covered and stored in a dry place at relatively uniform temperatures. Original rod or wire containers shall not be opened until ready for use. Rod and wire shall be free of moisture, lubricant, or other contaminants. Spools of wire temporarily left unused on the welding machine shall be kept covered to avoid contamination by dirt and grease collecting on the wire. If a spool of wire is to be unused for more than a short length of time, the spool shall be returned to the carton, and the carton shall be tightly resealed.

#### **Shielding Gases.**

**5.1** Shielding gases shall be welding grade or better.

**5.2** Shielding gas for gas metal-arc welding shall be argon, helium, or a mixture of the two (at least 50 percent helium).

**5.3** Shielding gas for gas tungsten-arc welding done with alternating current shall be argon.

**5.4** Shielding gas for gas tungsten-arc welding done with direct current, straight-polarity, shall be helium.

**5.5** Hoses used for shielding gases shall be made of synthetic rubber or plastic. Natural rubber hoses shall not be used. Hoses that have been previously used for acetylene or other gases shall not be used.

#### **Preparation of Materials.**

**6.1** Joint details shall be in accordance with design requirements and detail drawings. The locations of joints shall not be changed without approval.

**6.2** Edge preparation shall be by sawing, machining, clipping, or shearing. Gas tungsten-arc or gas metal arc cutting may also be used. Cut surfaces shall meet the ANSI surface roughness rating value of 1000. Oxygen cutting shall not be used.

**6.3** Surfaces and edges to be welded shall be free from fins, tears, and other defects which would adversely affect the quality of the weld.

**6.4** Dirt, grease, forming or machining lubricants, or any organic materials shall be removed from the areas to be welded by cleaning with a suitable solvent or by vapor degreasing.

**6.5** On all edges and surfaces to be welded, the oxide shall be removed just prior to welding by wire brushing or by other mechanical methods, such as rubbing with steel wool or abrasive cloth, scraping, filing, rotary planing, or sanding. If wire brushing is used, the brushes shall be made of stainless steel. Hand or power driven wire brushes which have been used on other materials shall not be used on aluminum.

**6.6** Where mechanical methods of oxide removal are found to be inadequate, a standard chemical method shall be used. Welding shall be done within 24 hours after chemical treatment.

## SECTION 716

6.7 When gas tungsten-arc welding with direct current, straight polarity, is being used, all edges and surfaces to be welded shall have the oxide removed by a standard chemical method.

6.8 Welding shall not be done on anodically treated aluminum unless the condition is removed from the joint area to be welded.

### Welding Procedure.

7.1 All butt welds requiring 100 percent penetration, except those produced with the aid of backing, shall have the root of the initial weld chipped or machined out to sound metal before welding is started from the second side. Butt welds made with the use of backing shall have the weld metal thoroughly fused with the backing. Where accessible, backing for welds that are subject to computed stress or that are exposed to view on the completed structure, and that are not otherwise parts of the structure, shall be removed and the joints ground or machined smooth. In tubular members, butt welds subjected to computed stresses shall be made with the aid of permanent backing rings or strips.

7.2 The procedure used for production welding of any particular joint shall be the same as used in the procedure qualification for that joint.

7.3 All welding operations, either shop or field, shall be protected from air currents or drafts so as to prevent any loss of gas shielding during welding. Adequate gas shielding shall be provided to protect the molten metal during solidification.

7.4 The work shall be positioned for flat position welding whenever practicable.

7.5 In both shop and field, all weld joints shall be dry at the time of welding.

7.6 The size of the electrode, voltage, amperage, welding speed, gas or gas mixture, and gas flow rate shall be suitable for the thickness of the material, design of joint, welding position, and other circumstances attending the work.

7.7 Gas metal-arc welding shall be done with direct current, reverse polarity.

7.8 Gas tungsten-arc welding shall be done with alternating current or with direct current, straight polarity.

7.9 When the joint to be welded requires specific root penetration, the Contractor shall make a sample joint and a macroetched cross-section of the weld to demonstrate that the joint welding procedure to be used attains the required root penetration. The sample joint shall have a length of at least 1 ft. ) and shall be welded with the electrode, polarity, amperage, voltage, speed, gas mixture, and gas flow rate that are proposed to be used in production welding. The Engineer, at his discretion, may accept evidence on record in lieu of the preceding test.

7.10 Where preheat is needed, the temperature of preheat shall not exceed 350 °F for heat-treated alloys and 600 °F for non-heat-treated alloys. The temperature shall be measured by temperature-indicating crayons or by pyrometric equipment. Heat-treated alloys shall not be held at the maximum preheat temperature or at temperatures near the maximum for more than 30 minutes.

### Weld Quality.

8.1 Regardless of the method of inspection, the acceptance or rejection of welds shall be determined by the following conditions:

- (a) Cracks in welds or adjacent base metal will not be acceptable.
- (b) Copper inclusions will not be acceptable.
- (c) Porosity in excess of that permitted by Section 3 and Section 10 of the ANSI/AWS D1.2 “ Structural Welding Code – Aluminum” will not be acceptable.
- (d) Lack of fusion, incomplete penetration, or tungsten or oxide inclusion will be acceptable only if small and well dispersed.

8.2 Undercut shall not be more than 0.01” deep when its direction is transverse to the primary stress in the part that is undercut. Undercut shall not be more than 1/32” deep when its direction is parallel to the primary stress in the part that is undercut.

8.3 No overlap shall be allowed.

8.4 All craters shall be filled to the full cross-section of the welds.

8.5 Welds having defects greater than the levels of acceptance specified above shall be considered as rejected unless corrected in accordance with 716.10.

### Inspection.

9.1 To determine compliance with Section 7, all welds shall be visually inspected, and in addition, all welds subject to computed stress shall be inspected by the dye penetrant method except as specified in 9.4.

9.2 For truss-type highway sign structures, the dye penetrant method shall be used on butt welds in columns and main chord members, on fillet welds connecting columns to bases and main chord members, including the associated flanges, gussets, or main load carrying brackets or members, and also on fillet welds connecting flanges to the main truss chord members. On pole type and

common light standards, the dye penetrant method shall be used on butt welds in columns and on fillet welds connecting columns to bases.

**9.3** The dye penetrant tests shall be performed in accordance with the requirements of ASTM E 165, Method B, Procedures B-2 or B-3.

**9.4** Dye penetrant inspection may be omitted provided that the Inspector examines each layer of weld metal with a magnifier of 3X minimum before the next successive layer is deposited.

#### **Corrections.**

**10.1** In lieu of rejection of an entire piece or member containing welding that is unacceptable, the corrective measures listed below may be permitted by the Engineer, whose approval shall be obtained prior to making each repair.

**10.2** Defective welds shall be corrected by removing and replacing the entire weld, or as follows:

- (a) Cracks in welds of base metal: Determine the full extent of the crack by the dye penetrant method or other positive means, then remove the crack throughout its length and depth, and rewelded.
- (b) Excessive porosity, lack of fusion: Remove the defective portions and reweld.
- (c) Copper or tungsten inclusions: Remove the defective portions and reweld.
- (d) Excessive concavity of the crater, undercut, or undersize weld: Clean and deposit additional weld metal.
- (e) Overlap: Reduce by removal of excess weld metal.

**10.3** The defective areas shall be removed by chipping or machining. Oxygen cutting shall not be used. Before rewelding, the joint shall be inspected to ensure that all of the defective weld has been removed. If dye penetrant has been used to inspect the weld, all traces of penetrant solutions shall be removed with solvent, water, heat, or other suitable means before rewelding.

#### **Qualification of Procedures, Welders, and Welding Operators.**

**11.1** Joint welding procedures that are to be employed in executing Contract work under these specifications shall be previously qualified by tests prescribed in Section 5 of the ANSI/AWS D1.2 “Structural Welding Code – Aluminum”. The qualifications shall be at the expense of the Contractor. At the Engineer’s discretion, evidence may be accepted of previous qualification of the joint welding procedures to be employed.

The fabrication shop shall maintain a file of certificates of qualification for its welders and welding operators and make the file available to the Engineer upon request. Each certificate of qualification shall state the name of the welder or welding operator, the name and title of the person who conducted the examination, the kind of specimens, the position of the welds, the results of the tests, and the date of the examination.

Upon request, the fabrication shop shall submit a letter of compliance to the Engineer listing by name all welders and welding operators employed on the fabrication of material for the project. The letter shall certify that these welders or welding operators have been prequalified and that they have been continuously engaged in gas metal-arc or gas tungsten-arc welding with no lapse in such employment in excess of six months since being prequalified.

**11.2** All welders and welding operators to be employed under these specifications shall be previously qualified by tests as prescribed in Section 5 of the ANSI/AWS D1.2 “Structural Welding Code – Aluminum”. At the Engineer’s discretion, evidence may be accepted of previous qualification of the welders and welding operators to be employed. The same process and type of equipment that are required for execution of the construction work shall be used in qualifying welders and welding operators.

**SECTION 718 -- RETROREFLECTIVE SHEETING**

**1.1 Description.** Retroreflective sheeting shall consist of a retroreflective microprismatic system having a smooth outer surface. When adhesive backing is used, the sheeting shall have a pre-coated adhesive on the back side protected by an easily removable liner.

**2.2 Detail Requirements.** Reflective sheeting and overlay film shall be selected from the [Qualified Products List \(QPL\)](#). Reflective sheeting and overlay film products will be included on the QPL after the Department determines conformance to the specifications and the manufacturer has supplied written information indicating conformance to the warranty requirements as noted under the acceptance criteria of the QPL. Determination of conformance will include, but will not be limited to, the evaluation of test data from AASHTO's National Transportation Product Evaluation Program (NTPEP) or other Department approved facilities except when otherwise indicated.

Retroreflective sheeting shall conform to the requirements of ASTM D 4956 including supplementary requirement and any exceptions and/or additions included herein.

**3.1** Retroreflective sheeting used on all Type A, AA, B, BB, C and CC signs, shall conform to the requirements of Type IV material except those specifically indicated otherwise herein.

**3.1.1** Retroreflective sheeting for the copy, border, and shields on overhead structures including bridge mounts shall conform to Type IV, VIII, IX, or XI material unless otherwise noted in the plans.

**3.2** Blank.

**3.3** Fluorescent Retroreflective sheeting for the following signs shall conform to Type VIII, IX, or XI material.

- Fluorescent yellow sheeting shall be used for all Horizontal Alignment Warning signs as defined by the MUTCD.
- Fluorescent orange sheeting shall be used on permanent orange construction and maintenance activity signs as prescribed under Section 619.

**3.5** Overlay films shall consist of highly durable, transparent, acrylic colored films coated with a transparent pressure sensitive adhesive protected by a removable translucent, synthetic, release liner.

**3.5.1 Test Methods:** Testing conditions and panels for the following test shall follow ASTM D 4956.

**3.5.1.1 Color Requirements.** When electronic cuttable film is applied to retroreflective sheeting, the resulting color of the composite sheeting will conform to Federal Specification FP-92, Section 718.01 and ASTM D 4956.

**3.5.1.2 Coefficient of Retroreflection,  $R_A$ .** When transparent colored electronic cuttable film is applied per the manufacturer's recommendations over white retroreflective sheeting, the colored composite will conform to the percentage specified in Table 1. The coefficient of retroreflection shall be determined in accordance with ASTM E-810.

**Table 1**

Coefficient of Retroreflection  $R_A$  \* for applied Overlay Films  
(expressed as % of white retroreflective sheeting background )

Transparent Color	Minimum	Maximum
Green	13.0	20
Blue	6.5	20
Red	14	24
Yellow	60.0	80
Orange	30	-
Brown	5.0	-

$R_A$  (cd/lux/m<sup>2</sup>) measurements shall be made at 0.2° observation angle, -4° entrance angle, and 0° rotation, per ASTM E-810. The ratio of the  $R_A$  (color) to  $R_A$  (white) shall be calculated and converted to a percentage to determine the film transmission values.

**3.5.1.5** The following ASTM D 4956 requirements shall meet the specific color of overlay film: Daytime Color

- Accelerated Outdoor Weathering
- Color Fastness
- Shrinkage
- Flexibility
- Liner Removal
- Adhesion
- Impact Resistance
- Specular Gloss

**3.6 Adhesive Liner.** The protective lay flat liner shall be a synthetic film liner resistant to moisture absorption and curl. The liner shall be printed with an indelible mark indicating the name of the film manufacturer.





AASHTO Specifications .....	1-24, 1-33	Buildings, Demolishing .....	2-4
Abbreviations .....	1-1	Catch Basins .....	6-13
<b>Acceptance</b>		Cement	
<b>accept</b> .....	1-2	Mortar .....	7-3
Final .....	1-2	Storage of .....	5-30
Final Payment .....	1-68	Certificate	
Partial .....	1-28	Insurance .....	1-48
Project .....	1-29	Of Compliance .....	1-39
Adjustment, Claims for .....	1-29	Channel Excavation .....	2-27
Admixtures for Cement .....	5-29	Character of Workers .....	1-54
Aggregate(s)		Civil Rights .....	1-50
Stockpiles .....	3-3	Claim	
Agreement		Resolution .....	1-31
Disposal .....	1-41	Claims	
Air Pollution .....	1-44	For Adjustment .....	1-29
Altered Quantities, Compensation for .....	1-63	For Extension of Time .....	1-55
Approval of Working Drawings .....	1-22	On Final Estimate .....	1-68
Assigning of Contract .....	1-50	Responsibility for Damage .....	1-48
Attachment, Exemption from .....	1-46	Time Limit for .....	1-68
Authority of		Cleaning Up, Final .....	1-18
Engineer .....	1-22	Clearing .....	2-1
Representatives of the Engineer .....	1-26	Cofferdams .....	5-4, 5-7
Award		Collusion Among Bidders .....	1-9
Cancellation of .....	1-11	Combination Proposals .....	1-9
Of Contract .....	1-11	Common Excavation .....	2-8
Bankruptcy .....	1-58	Compensation for Altered Quantities .....	1-63
Barricades and Warning Signs .....	1-47, 6-69	Complete on Time, Failure to .....	1-58
Barrier Membrane .....	5-80	Completion .....	1-3
Peel and Stick .....	5-80	Completion Date .....	1-3
Base Courses .....	3-1	Compliance, Certificate of .....	1-39
Beneficiary, No Third Party .....	1-50	Computing Volumes .....	1-61
Bid Proposal, Quantities in .....	1-6	Concrete Masonry	
Bid(s)		Classification .....	5-26
Opening of .....	1-9	Cold Weather .....	5-44
Opening of, Time Limit for Award After .....	1-11	Forms and Falsework, Construction of .....	5-39
Bidders		Forms and Falsework, Removal of .....	5-48
Disqualification of .....	1-9	Hot Weather .....	5-45
Prequalification of .....	1-6	Repairs, Bridge Deck, Preparation .....	5-22
Bidding Requirements and Conditions .....	1-6	Slope Paving .....	5-150
Bituminous		Under Water .....	5-42
Materials, Measurement .....	1-61	Waterproofing Surfaces .....	5-76
Blasting		Conduit, Electrical .....	6-42
Care in .....	1-47	Conformity with Plans and Specifications .....	1-23
Blotter Material .....	4-34	Conservation of	
Bond, Contract .....	1-11	Gravel .....	1-41
Borings .....	1-7	Growth, Roadside Trees and Shrubs .....	2-8
Borrow		Construction	
Free .....	5-155	Equipment .....	1-54
Measurement in Vehicles .....	1-61	Maintenance During .....	1-28
Bounds .....	6-74	Over or Adjacent to Navigable Waters .....	1-18
Bridge		Signs and Warning Devices .....	6-69
Approach Rail .....	5-141	Stakes, Lines, and Grades .....	1-25
Backfill .....	5-6	Zone(s) .....	1-27
Deck Repairs, Preparation .....	5-22	Contract .....	1-3
Excavation .....	5-6	Acceptance and Final Payment of .....	1-68
Opening to Traffic .....	1-27	Assigning of .....	1-50
Railing .....	5-138	Award of .....	1-11
Removal of Existing .....	5-3	Bond, Requirement of .....	1-11
Temporary .....	5-1	Concurrence by Governor and Council .....	1-11

# INDEX

Default of.....	1-58	Engineer	
Execution and Approval of .....	1-13	Authority and Duties of Representatives of.....	1-26
Failure to Complete on Time .....	1-58	Authority of .....	1-22
Failure to Execute .....	1-13	Field Facilities for .....	6-125
Intent of.....	1-14	Term Implied.....	1-5
Partial Payments .....	1-67	Environmental Protection.....	1-19
Revision .....	1-4, 1-14, 1-23	Epoxy Coating .....	5-78
Subletting of.....	1-51	Equipment	
Termination of.....	1-59	Other than Specified.....	1-55
Time, Determination and Extension of.....	1-55	Publicly-Owned.....	1-62
Contractor		Size and Condition .....	1-54
Cooperation by.....	1-24	Sufficient.....	1-58
To Furnish Labor, etc. to Complete Contract Items..	1-14	Erosion Control .....	6-94
Contractor's Responsibility		Errors, Inaccuracies.....	1-23, 1-26
For Work.....	1-18	Examination of Plans and Work Site .....	1-7
Taxes .....	1-44	Excavation	
Termination of.....	1-60	And Embankment .....	2-8
To Public.....	1-42	Bridge.....	5-6
Contractors, Cooperation Between .....	1-25	Channel.....	2-27
Control of		Structure.....	2-25
Materials .....	1-32	Exploratory Trench.....	2-26
Work.....	1-22	Explosives	
Cooperation		Insurance .....	1-49
Between Contractors .....	1-25	Use of.....	1-47
By Contractor .....	1-24	Extension of Contract	
With Utilities .....	1-24	Time.....	1-55
Coordination of Specifications.....	1-23	Extra Work .....	1-15
Critical Path Method		fabric	
Progress Schedule .....	1-52	geotextile.....	5-160
Requirements.....	1-52	Failure to	
Crushed Gravel .....	3-1	Begin the Work .....	1-58
Culverts and Storm Drains.....	6-1	Complete Work on Time.....	1-58
Curbs.....	6-38	Maintain Roadway or Structure.....	1-28
Damage Claims, Responsibility for .....	1-48	Restore Property.....	1-48
Damages, Liquidated .....	1-58	Falsework .....	5-39, 5-118
Default of Contract .....	1-58	Federal Participation.....	1-46
Defective Materials .....	1-27, 1-41	Fences .....	6-31
Definitions .....	1-1	Fertilizer .....	6-88, 6-107
Delay.....	1-4	Final	
Delineators .....	6-22, 6-72	Acceptance .....	1-29
Demolishing Buildings .....	2-4	Cleaning Up.....	1-18
Density Requirements .....	2-20	Payment.....	1-68
Determination of Contract Time.....	1-55	Final Pay Quantity .....	1-69
Detours .....	1-16, 1-22	Fine Grading.....	2-31
Differing Site Conditions.....	1-14	Fire Control .....	1-48
Disadvantaged Business Enterprise Program .....	1-11	Force Account .....	1-62
Discrepancies.....	1-23	Forest Protection .....	1-48
Disposal		General Provisions .....	1-1
Of Surplus and Waste Materials.....	1-41, <u>2-21</u>	GEOTEXTILES.....	5-160
Disputed Work.....	1-29, 1-68, See Claims	Grades, Construction .....	1-25
Disqualification of Bidders.....	1-9	Grading, Fine.....	2-31
Drawings, Working or Shop.....	1-22, 5-4, 5-39, 5-100, 5-129, 5-134, 5-139	Granular Backfill.....	2-28
Dredging .....	1-43	Grass Seed.....	6-90
Drop Inlets.....	6-13	Gravel.....	3-1
Dust Control		Conservation of.....	1-41
Roadway.....	6-67, 6-68	Pits Adjoining Highways.....	1-32
Earthwork .....	2-1	Grubbing .....	2-1
Electrical Conduit.....	6-42	Guaranty	
Embankments.....	2-8, 2-20, 2-21	Bid1-8	
Employees, Character of.....	1-54	Return of Bid.....	1-11
		Guardrail .....	6-21

Hazardous Materials .....	1-50	Inspected, Sampled and Tested .....	1-32
Health Provisions .....	1-46	Local Sources of.....	1-32
Highways Closed to Traffic.....	1-47	Not on Hand, Payment for .....	1-67
Hot Bituminous		On Hand, Payment for.....	1-67
Pavement.....	4-30	Rejected .....	1-41
Humus .....	6-103	Storage of .....	1-41
impact attenuators .....	6-22	Sufficient, for Completion on Time .....	1-58
Incidental Construction.....	6-1	Unacceptable .....	1-41
Insolvency .....	1-58	Measurement	
Inspection		and Payment .....	1-61
Of Welds, Nondestructive.....	5-105	of Quantities.....	1-61
Of Work.....	1-26	Methods and Equipment.....	1-54
Plant.....	1-40	Mobilization.....	6-121
Inspectors.....	See Representatives of the Engineer	Muck Excavation.....	2-19
Insurance		Municipally-Owned Equipment.....	See Publicly
Certificates.....	1-48	Navigable Waters .....	1-18
Explosives.....	1-49	Notice to Proceed.....	1-51
Public Liability and Property Damage .....	1-48	Notification	
Worker’s Compensation .....	1-49	Contractor .....	1-15
Intent of Contract.....	1-14	Numbers, Item and Section .....	1-2
Irregular Bids.....	1-8	Office, Field.....	6-125
Item Numbers .....	1-2	Officials, Personal Liability of Public .....	1-50
Items, Eliminated .....	1-15	Opening	
joint sealant		Bids.....	1-9
silicone .....	5-137	Concrete Bridge Decks .....	1-27
Laboratory, Physical Testing (Field).....	6-125	To Traffic .....	1-28
Laws		Openings in Highway .....	1-18
Familiarity with .....	1-7	Operations	
Observance of.....	1-42	Limitations.....	1-54
Legal		Schedule of.....	1-51
Relations .....	1-42	Paint .....	7-4
Rights, No Waiver of .....	1-50	Painting Existing Structural Steel.....	5-124
Liability		Partial	
For Subcontractors, Contractor’s.....	1-42	Acceptance of Project .....	1-28
Insurance .....	1-48	Payments.....	1-67
Of Public Officials, Personal .....	1-50	Participation, Federal .....	1-46
Licenses, Permits, and Taxes.....	1-44	Patented Devices, Materials, and Processes .....	1-46
Light Pole Bases.....	6-77	Pavement Markings, Retroreflectorized.....	6-79
Limestone.....	6-87	Pavements.....	4-1
Limitation of Operations .....	1-54	Aggregate .....	4-1
Lines and Grades .....	1-25	Hot Bituminous .....	4-30
Liquidated Damages.....	1-58	Hot Bituminous, Hand Method .....	4-30
Load Restrictions.....	1-27	Sawed.....	6-78
Loam .....	6-86	Payment	
Local Material Sources .....	1-32	Contingent Upon Funds.....	1-60
Lump Sum Work.....	1-62	Final.....	1-68
Maintain Roadway or Structure, Failure to .....	1-28	For Material, Found on the Work.....	1-17
Maintenance		For Material, Not on Hand .....	1-67
During Closure .....	1-47	For Material, On Hand.....	1-67
During Construction.....	1-17, 1-28	Force Account .....	1-63
During Suspension .....	1-54	Negotiated Prices .....	1-63
Of Traffic .....	1-16, 6-67	Partial .....	1-67
Manholes .....	6-13	Revisions to Contract .....	1-63
Markers		Scope of.....	See Intent of Contract
Witness .....	6-74	Permit(s)	
Material(s)		Licenses and Taxes .....	1-44
Control of.....	1-32	Restoration of Surfaces Opened by.....	1-18
Department-Furnished .....	1-41	Personnel	
Found on the Work, Rights and Use of .....	1-17, 2-8	During Suspension.....	1-54
Handling.....	1-41	Removal of .....	1-54
Hazardous .....	See Hazardous Materials	Skill and Experience.....	1-54

# INDEX

Pile Locations, Fill Material at.....	2-20
Piling, Sheet .....	5-9
Pipe(s)	
Culverts .....	6-1
Plate .....	5-156
Removal.....	2-5
Removal for Relaying.....	6-9
Sleeve.....	6-8
Structural Plate.....	5-156
Underdrain .....	6-18
Pit(s)	
Limits.....	1-32
Plans	
Conformity With.....	1-23
Coordination with Specifications.....	1-23
Examination of, by Bidder .....	1-7
Interpretation of, by Engineer.....	1-22
Working Drawings .....	See Drawings
Plant Inspection.....	1-40
Plant Material	
General.....	6-106
Inspection of.....	1-40
Transplanting.....	6-120
Pollution Control	
Air 1-44	
Water .....	6-131
Prefabricated Compression Joint.....	5-129, 5-132
Preparation	
For Concrete Bridge Deck Repairs .....	5-22
For Concrete Repairs .....	5-25
Prequalification of Bidders .....	1-6
Proceed, Notice to.....	1-51
Progress Schedule.....	1-52
Bar Chart Method.....	1-53
Critical Path Method .....	1-52
Progress Schedules .....	1-51
Critical Path .....	1-4
Property	
Damage Insurance.....	1-48
Protection and Restoration of.....	1-47
Proposal(s)	
Combination.....	1-9
Consideration of.....	1-11
Contents of.....	1-6
Delivery of .....	1-8
Electronic.....	1-8, 1-9
Guaranty, Forfeiture of .....	1-13
Irregular.....	1-8
Issuance of.....	1-6
Opening of.....	1-9
Paper .....	1-7
Preparation of .....	1-7
Quantities in .....	See Bid Proposal
Return of Guaranty.....	1-11
Signed.....	1-7
Unit Prices .....	1-7
Value Engineering, by Contractor.....	1-19
Withdrawal of.....	1-9
Protection	
Environmental.....	1-19
Forest .....	1-48
Of Property and Landscape .....	1-47
Provisions	
General .....	1-1
Sanitary, Health, and Safety.....	1-46
Public	
Convenience and Safety .....	1-47
Liability Insurance .....	1-48
Officials, Personal Liability of.....	1-50
Responsibility to .....	1-42
Utilities.....	1-24
Publicly-Owned Equipment.....	1-62
Quality Requirements .....	1-32
Quantities	
Altered .....	1-63
In Bid Schedule, Interpretation of.....	1-6
Measurement of.....	1-61
Rail	
Bridge Approach .....	5-141
Guard .....	6-21
Railing	
Bridge.....	5-138
Rebuilding Damaged Work .....	1-48
Reclaimed Stabilized Base.....	3-7
Reinforcing Steel.....	5-84
Release of Contractor .....	1-60
Removal of	
Abandoned Road Surface .....	2-8
Existing Bridge Structure.....	5-3
Hazardous Materials .....	1-50
Structures and Obstructions .....	2-4
Unacceptable Materials.....	1-41
Unauthorized Work .....	1-26
Underground Storage Tanks and Hazardous Materials.....	2-5
Rental Charge, Equipment .....	1-65
Repairs	
Preparation for Concrete.....	5-25
Preparation for Concrete Bridge Deck.....	5-22
Representatives of the Engineer, Authority of.....	1-26
Responsibility	
For Damage Claims .....	1-48
For the Work.....	1-18
Termination of Contractor's .....	1-60
To Public .....	1-42
Restoration of	
Property and Landscape .....	1-47
Surfaces Opened by Permit .....	1-18
Restrictions, Load.....	1-27
Retest of Materials.....	1-33
Revisions	
to the Contract.....	1-14
Rights	
Civil .....	1-50
In Materials Found on the Work.....	1-17
No Waiver of Legal.....	1-50
Roadside Cleanup .....	2-2
Roadway, Failure to Maintain .....	1-28
Rock Excavation .....	2-8
Safety	
Public .....	1-47
Sanitary and Health Provisions .....	1-46
Samples.....	1-32
Sand .....	3-1
Sanitary Provisions.....	1-46

Sawed Pavement.....	6-78	Suspensions of Work .....	1-15
Schedule		Taxes	
Of Operations .....	1-51	Contractor's.....	1-44
Quantities in .....	1-6	Permits and Licenses .....	1-44
Seed, Grass.....	6-90	Subcontractor's .....	1-45
Shear Connectors .....	5-87	User's .....	1-46
Sheet Piling.....	5-9	Telephone Service .....	6-129
Shop Drawings .....	See Drawings	Temporary Bridge.....	5-1
Shrubs		Temporary Water Pollution Control.....	6-131
Care While Excavating .....	2-8	Termination	
Deciduous .....	6-117	Of Contract.....	1-59
Evergreen.....	6-116	Of Contractor's Responsibility.....	1-60
Sidewalks.....	6-35	Terms, Definitions and.....	1-1
Signals, Traffic .....	6-53	Tests .....	1-32
Significant Changes in the Character of Work.....	1-14	Third Party Beneficiary, No.....	1-50
Signs		Timber, Structural.....	5-142
And Barricades.....	1-47, 6-67	Time	
Construction .....	6-67	Determination and Extension of Contract.....	1-55
Guide .....	6-68	Failure to Complete on.....	1-58
Traffic.....	6-46	Tolerances, Manufacturing.....	1-62
silicone joint sealant.....	5-137	Town Highways.....	1-27
Site of Work, Examination of .....	1-7	Traffic	
Slope Paving with Concrete.....	5-150	Maintenance of.....	1-16
Sod .....	6-104	Opening Sections of Project to.....	1-28
Source of Supply, Requirements .....	1-32	Signals .....	6-53
Sources, Local Material .....	1-32	Signs .....	6-46
Special Provisions		Traffic Control Plan.....	1-54
Coordination of.....	1-23	Training Programs .....	6-122
Examination of.....	1-7	Transplanting Plant Material .....	6-120
Specialty Items .....	1-51	Tree(s)	
Specifications		Care While Excavating .....	2-8
Cited.....	1-32	Deciduous.....	6-115
Conformity With .....	1-23	Evergreen .....	6-114
Coordination of.....	1-23	Trimming .....	2-2
Examination of.....	1-7	Trench Excavation .....	See Structure Excavation
Interpretation of.....	1-22, 1-23	Turbidity .....	1-43
Stakes, Construction .....	1-25	Turf Establishment.....	6-102
Stone		Unacceptable	
Masonry.....	5-145	Materials .....	1-41
Walls .....	5-148	Work, Removal of.....	1-26
Storage of Materials.....	1-41	Unauthorized Work, Removal of.....	1-26
Storm Water Pollution Prevention Plan .....	6-94	Unclassified Excavation .....	2-8
Structural		Underdrains.....	6-18
Fill 5-10		Underground Facilities .....	1-24
Plate Pipes .....	5-156	Underground Storage Tanks and Hazardous Materials, Removal of.....	2-5
Timber.....	5-142	Understanding of Parties Regarding Department's Performance 1-60	
Structure(s) .....	5-1	Unsuitable Material .....	2-21
Excavation.....	2-25	User's Taxes.....	1-46
Failure to Maintain .....	1-28	Utilities, Cooperation with.....	1-24
Stumps, Removing .....	2-1	Value Engineering Proposals by the Contractor .....	1-19
Subcontract .....	1-51	Vines and Ground Covers .....	6-119
Subcontractors, Contractor's Liability for .....	1-42	Volumes, Computing .....	1-61
Subletting of Contract .....	1-51	Waiver of Legal Rights, No.....	1-50
Sunday Work.....	1-54	Warning Signs.....	1-47
Superintendent .....	1-24	<u>Waste, Disposal of</u> .....	<u>2-21</u>
Supplemental		Water	
Plans.....	See Drawings	Pollution .....	6-131
Specifications, Coordination of.....	1-23	Repellent .....	5-77
Supply, Source of .....	1-32	Water Diversion Structures .....	5-4
Surety.....	1-59		
<u>Surplus Material, Disposal of</u> .....	<u>2-21</u>		

# INDEX

Waterproofing .....	5-76	Examination of Site .....	1-7
Waterstops .....	5-83	Holiday .....	1-54
Weight and Weighing .....	1-61	Inspection of .....	1-26
Welding		Removal of Unacceptable and Unauthorized .....	1-26
Aluminum Alloys .....	7-28	Scope of .....	1-14
Winter Construction .....	2-20, 3-5	Start of .....	1-51
Witness Markers.....	6-74	Sunday .....	1-54
Work		Use of Materials Found on.....	1-17, 2-8
Complete in Place.....	1-2	Worker's Compensation Insurance .....	1-49
Contractor's Responsibility for .....	1-18	Working Drawings.....	See Drawings
Control of .....	1-22	Zone, Construction.....	1-27