

# Best Management Practices for Routine Roadway Maintenance Activities in New Hampshire



2019

## Acknowledgements

A number of engineering and environmental professionals contributed in the development of this updated manual. Without the assistance of the following individuals, the compilation of information and preparation of this manual would not have been possible:

Kevin Nyhan, Administrator, NHDOT Bureau of Environment  
Melilotus Dube, Environmental Manager, NHDOT Bureau of Environment  
Matt Urban, Chief Operations Management Section, NHDOT Bureau of Environment  
NHDOT District Operations: Districts 1, 2, 3, 4, 5, & 6.  
Bureau of Bridge Maintenance

Jocelyn Degler, Public Highway Specialist, NHDES Wetlands Bureau  
Karl Benedict, Wetlands Specialist, NHDES Wetlands Bureau  
Mary Ann Tilton, Assistant Administrator, NHDES Wetlands Bureau

**Prepared by: Matt Urban**  
Chief, Operation Management Section  
New Hampshire Department of Transportation  
Bureau of Environment

This manual represents many working hours in a joint effort between the New Hampshire Department of Environmental Services and the New Hampshire Department of Transportation.

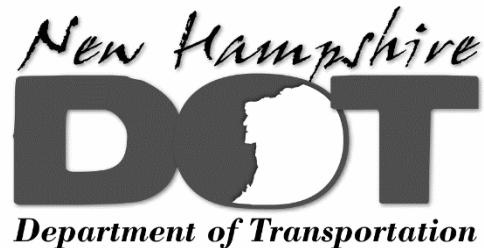

**For more copies, contact:**  
DOT Bureau of Environment  
PO Box 00483, 1 Hazen Drive  
Concord, NH 03302-00483  
(603)271-3226

**This manual is also available online at:**

[WWW.NHDOT.COM](http://WWW.NHDOT.COM)

# Table of Contents

## Contents

Introduction and Purpose of this Manual.....	6
Background .....	6
Purpose .....	6
Certified Culvert Maintainer Program (CCMP) .....	7
Planning Section: Culvert Assessments .....	7
Identifying when there is a need to do work.....	7
Plan annual maintenance inspections .....	7
Improve Safety .....	8
Appropriately sizing a structure.....	8
Planning Section: Environmental Considerations.....	9
Wetlands .....	9
Aquatic Organism Passage (AOP) and Connectivity .....	12
Avoidance and Minimization .....	12
Aquatic Restoration Mapper.....	13
Designated Rivers.....	14
Natural Heritage Bureau (NHB) .....	15
Invasive Species .....	18
Construction.....	18
General Criteria for Project Activities .....	19
Project Activities that Qualify for the Routine Roadway Notification Process/Activity Sketches .....	21
General Conditions that apply to All Routine Roadway and Railway Maintenance Activities: .....	23
Activity RR-1: Culvert Replacement or Repair .....	24
Activity RR-2: Culvert Extension.....	25
Activity RR-4: Embankment Stabilization.....	27
Activity RR-5: IN-KIND Headwall Repair Only, on Any Size Culvert.....	28
Activity RR-6: Headwall Construction, Repair or Replacement .....	29
Activity RR-7: Roadside Ditch Maintenance .....	30

Activity RR-8: Culvert Inlet and Outlet Maintenance.....	31
Activity RR-9: Temporary Scaffolding .....	32
Best Management Practices .....	33
BMP #1: Silt Fence.....	34
BMP #2: Erosion Control Mix Berm .....	35
BMP #3: Continuous Contained Berm (Staked Filter Sock/Straw Wattle).....	38
BMP #4: Temporary Storm Drain Inlet Protection.....	40
BMP #5: Temporary Stone Check Dam .....	43
BMP #6: Temporary Cofferdam (Temporary Diversion/Clean Water Bypass) .....	45
BMP #7: Sediment Filter Bag .....	48
BMP #8: Sediment Retention Basin .....	50
BMP #9: Outlet Protection.....	52
BMP #10: Turbidity Curtain.....	53
BMP #11: Erosion Control Blanket/Matting .....	54
BMP #12: Surface Roughening and Slope Tracking .....	57
BMP #13: Temporary and Permanent Mulching (Hay, Straw, Wood Chip, Bark) .....	59
BMP #14: Permanent Vegetation (Seeding) .....	61
Appendix A:.....	64
GPS Data Collection .....	64
Appendix B: Wetland Resource Identification .....	66
B.1 Wetland Types .....	66
B.2 Forested Wetlands.....	67
B.3 Scrub-Shrub Wetlands .....	67
B.4 Emergent Wetlands .....	68
B.4.1 Marshes .....	68
B.4.2 Wet Meadows.....	68
B.4.3 Bogs.....	68
B.5 Streams and their Banks .....	69
B.6 Vernal Pools .....	69
B.7 Wetland Buffers.....	70
B.8 Wetland Vegetation.....	70
Common Plants Found in Different Wetlands in New Hampshire .....	72

Trees.....	72
Shrubs .....	72
Herbs.....	73
Hydric Soils.....	74
Wetland Hydrology .....	75
How to Identify Wetlands.....	75
Appendix D: Invasive Species Plant Identification .....	76
Common Reed.....	76
Glossy Buckthorn .....	77
Japanese Knotweed .....	77
Oriental Bittersweet.....	78
Purple Loosestrife .....	78
Appendix E: New Hampshire Designated Rivers Map .....	80
Appendix F: Prime Wetlands.....	80
Definitions.....	80

# Introduction and Purpose of this Manual

## **Background**

The New Hampshire Department of Transportation (NHDOT) and other state municipalities maintain approximately 17,029 miles of roadway in this state. Many of these roads are on locations originally laid out by New Hampshire's settlers while others are new roadways constructed in recent years. In both instances, routine maintenance activities are necessary to preserve the integrity of the roadway infrastructure. An important component of the maintenance program is drainage control. This is principally conducted through the replacement of culverts, cleanout of the channels leading to the culverts and repair of erosion caused by flowing water.

Many of these routine maintenance activities require a wetland permit for dredge or fill in areas commonly associated with roadway drainage. In order to provide better management of routine maintenance activities in the future, NHDOT, in conjunction with the New Hampshire Department of Environmental Services Wetlands Bureau (NHDES Wetlands Bureau), has developed this manual of Best Management Practices (BMPs). The original 2001 BMPs were revised to provide consistency with the changes to [RSA 482-A](#) and the [wetlands rules](#).

## **Purpose**

The State of New Hampshire is faced with the critical challenge of maintaining, and improving its existing infrastructure. The majority of the State's infrastructure has aged in the last 30 years to the point of being structurally deficient and functionally obsolete. The intent and goal of this manual is to address the needs of New Hampshire's infrastructure while protecting the environment by improving aquatic organism passage and considering hydrologic and other environmental constraints.

Roadway maintenance personnel are trained to identify roadway drainage structures in need of improvement. This manual will act as a management tool and as a technical guide for routine maintenance activities in areas under the jurisdiction of RSA 482-A. These routine maintenance activities include: **1) Culvert Replacement or Repair, 2) Culvert Extension, 3) Culvert Relocation, 4) Embankment Stabilization, 5) In-kind Headwall Repair, 6) Headwall Construction, Repair or construction, 7) Roadside Ditch Maintenance, 8) Maintenance of Culvert Inlets and Outlets, and 9) Temporary Scaffolding.**

This manual can be used by State Highway Maintainers, Municipal Road Agents, and/or private landowners (note: Some restrictions may apply to certain activities for landowners).

The purpose of this manual is to provide a menu of activities paired with best management practices from which all roadway maintenance personnel may select practices appropriate to specific sites, specific conditions and employ the most effective control measures for protecting the environment. It is important to meet the goals of this manual for many reasons primarily including the protection of roadway infrastructure from future storm events, improving water quality within the State's watercourses, protecting wetland resources and improving aquatic organism passage.

It is equally important to note that this is NOT a technical engineering manual. Design recommendations and/or specifications for individual activities must originate from qualified representatives, designated as an activity sponsor.

### **Certified Culvert Maintainer Program (CCMP)**

Public Employees of Municipalities, the State of New Hampshire or the Federal Government may become Certified Culvert Maintainers in accordance with RSA 482-A and the Rules Adopted in Env-Wt-900 – Stream Crossings.

For more information on becoming certified, please refer to the [UNH Technology Transfer Website](#).

**Note: Some activities proposed in the revised manual are not allowed under the Certified Culvert Maintainer Program (CCMP). Specifically, activities RR-4, RR-5, RR-7 and RR-9 cannot be completed under the CCMP. Also, please note specific criteria and conditions may be different for projects being completed through the CCMP. Conditions and Criteria that differ from the Routine Roadway Maintenance Activities will be called out on each activity sheet.**

## **Planning Section: Culvert Assessments**

Good planning can make the difference between a successful job and one that ends in possible disaster. Take the time to understand all the activities allowed in this manual and then plan accordingly. Whether you work for the State, a municipality, and/or if you are a private landowner, this manual can guide you towards a successful job.

### **Identifying when there is a need to do work**

- Conduct annual maintenance inspections to identify any problems.
- Know the condition of the existing infrastructure.
- Look for signs of deterioration.
- Are there opportunities to improve safety?
- Is the structure appropriately sized?
- Ask questions that help you understand the problem and lead towards a solution.
- What is the scope of work?
- What are the site conditions like?
- What resources are in the area?
- What are the limitations (time, budget, resources, technology, etc.)?

### **Plan annual maintenance inspections**

Planning regular annual maintenance inspections is the best way to monitor the deterioration of assets and the surrounding resources in the field, while identifying structures that are in need of repair/replacement. In addition to annual maintenance inspections, an inspection should be done after any major rainstorm event that may have compromised the integrity of a structure and/or roadway safety.

It is important to monitor and recognize the continued deterioration of a structure over a course of time so that adequate time for planning is available to allocate pull together a budget, obtain necessary permits and collect the materials needed to do the work.

**Indications of significant deterioration and/or loss of function include, but are not limited to:**

- Varying degrees of rust
- A collapsed pipe
- A separated pipe segment/joint
- Sink holes
- A sag in the road
- A structure that is full of sediment/ blockages
- Scour underneath and/or around the pipe
- Loss of embankment

**Improve Safety**

One driving force for routine roadway maintenance is the need to address safety concerns that currently exist. Routine roadway maintenance allows for infrastructure to be brought back up to the current safety standards. Well maintained roads are safer and improve the quality of life for the traveling public, pedestrians and cyclists, while improving the economy for the state and local businesses.

**Appropriately sizing a structure**

When sizing a structure, there are numerous factors that go into the decision, such as:

- Streambed type
- Slope
- Structure material
- Flow characteristics
- Volume of water
- Aquatic organism passage
- Geomorphic Compatibility

**Before replacing a culvert with a larger structure, it is essential to consider impacts to:**

- Upstream and downstream flooding
- Potential for erosion and headcutting
- Channel dimension, pattern, and profile in the vicinity of the structure  
Sediment transport capacity
- Stability of the existing structure
- Stream stability (vertical and lateral)
- Upstream and downstream habitat (in stream habitat, wetlands, riparian buffer, riparian areas)

The replacement crossing will need to be designed in order to maximize the benefits and minimize the potential for problems as a result of the larger culvert.



**Indications that a structure may be undersized and in need of being upsized include, but are not limited to:**

- Significant headwater at the inlet of a culvert
- Perched condition at inlet or outlet
- Downstream ponding
- Overtopping of stream banks
- Roadway flooding
- Downstream scour and erosion
- Accelerated deterioration

**Anticipating site conditions and surrounding resources:**

- *Conduct a field investigation of the site prior to developing a scope of work to understand the known resources within the project area.*
- Avoid and/or minimize the impacts to the resource area to meet the standard of the least impacting alternative to the resource while meeting project goals. Specific measures to control, minimize and protect the surrounding resources are required and are an important part of your planning process.
- Expand the limits of your field investigation to determine what limitations there may be at the site, such as:
  - Accessibility of the work area
  - Constructability
  - Small wetlands adjacent to or near the project area
  - Invasive species
  - Viable dewatering locations
  - Aerial/underground utilities
  - Traffic control
  - Determine if the proposed method of access and construction will impact a resource that would otherwise not be allowed under the activities covered in this manual.

## **Planning Section: Environmental Considerations**

### **Wetlands**

Good planning, regardless of the need for a permit, requires all projects follow clear and enforceable environmental performance standards. The BMPs in this manual have been compiled in an effort to help you meet these performance standards. BMPs should be chosen to meet the site-specific conditions of your project and to best protect aquatic resources and water quality during construction.

#### **What is a Wetland?**

Wetlands are defined as those areas that are inundated or saturated with surface or groundwater at a frequency and duration sufficient to support, and that under normal circumstances do support, a prevalence of vegetation typically adapted for life in saturated soil conditions.

Wetlands are generally found in depressions, fringes of streams, at the toe of slopes or in other areas where water seems to collect. Wetlands in New Hampshire are identified using a three-parameter approach of 1) hydrophytic (wetland) vegetation, 2) hydric soils and 3) wetland hydrology.

There are several kinds of wetlands, including forested wetlands (swamps), scrub-shrub wetlands, emergent wetlands (marshes), wet meadows and vernal pools. Detailed descriptions and photographs of these wetlands can be found in [Appendix B – Wetland Resource Identification](#).

For an official wetland plant list, see <https://plants.usda.gov/java/>.

Streams are also within the jurisdiction of the NHDES Wetlands Bureau. NHDES defines three different types of streams:

***Ephemeral stream*** means a watercourse that is located above the water table year round and is not fed by groundwater, such that runoff from rainfall and snowmelt is the primary source of stream flow and so the stream has flowing water only during, and for a short duration after, precipitation or spring thaw events., but which has less flow than an intermittent stream and no evidence of riffles, meander bends, point bars, or braiding.

***Intermittent stream*** means a watercourse that is fed by groundwater but is not in the groundwater table throughout the year, where runoff from rainfall and snowmelt is a supplemental source of water for flow, such that the stream typically does not have flowing water during dry portions of the year.

***Perennial stream*** means a watercourse that is in the groundwater table for most of the year and so has groundwater as its primary source of water for stream flow, with runoff from rainfall and snowmelt as a supplemental source of water, so that it contains flowing water year-round during a typical year.

#### **How do I know if I am in a Wetland?**

Identification of wetlands is done according to the USACOE 1987 method, using the current North Central and North East Regional Supplement. In accordance with the law, wetland delineations can only be done by Wetland Scientists certified by the New Hampshire Board of Licensure, or by employees of the government of the United States or the State of New Hampshire if the project is for a government entity. The Wetlands Type Section of the appendix contains specific and detailed information for identifying wetland plants, soils and hydrology; however, some basic guidelines for determining if an area is a wetland are listed below.

#### **Does the area have standing water?**

During most times of the year, if there is standing water, the area is most likely a wetland. It is important to note, however, that in the spring when water tables are at their highest, many areas that are not wetlands may have standing water. These areas are still of concern because of the high water table. Any excessive activity in these areas may cause rutting and soil disturbance that can lead to erosion and water quality issues.

**Is the area void of any woody plants?**

Typically areas that don't have woody plants, such as shrubs or trees, are marsh or wet meadow wetlands. Marsh areas are dominated by herbaceous plants such as grasses, sedges and reeds, and the water table is at or above the surface throughout the year but can fluctuate seasonally. "Wet meadow" means an herb-dominated area typically with non-woody vegetation less than three feet in height, saturated for long periods during the growing season, but seldom flooded. Wet meadows develop on predominantly poorly-drained soils and are often found in agricultural areas.

**Is there a defined channel?**

A defined channel is one of the criteria that NHDES uses to identify streams, whether they are perennial, intermittent or ephemeral streams.

**Do plants typically found in wetlands dominate the area?**

Knowing a few key species of plants will help in determining if an area is a possible wetland. Areas dominated by shrub species, such as speckled alder, willow, high bush blueberry and meadowsweet, are typical of wetlands. Also, areas with certain tree species, such as red maple, or large fern species, such as cinnamon fern, are indicators of a wetland. (<https://extension.unh.edu/Marsh-and-Shrub-Wetlands#resources>)

**Does the area look like it ponds water during wetter times of the year?**

While working in an area during dryer summer months, it may seem more difficult to determine if an area is a wetland but the ground will provide clues. Areas with gray or black-stained leaves on the ground mean that the area was ponded. Look for pit and mound micro-topography where trees and shrubs are growing on the mounds. Carefully investigate low lying areas where it looks like water would collect.

**Does the area display indications of hydric soils?**

It can sometimes be easy to identify certain hydric soils without performing a full soil analysis. Soils that are obviously saturated and mucky, clay-like, light to dark grey in color, contain black or reddish concentrations or have a distinctly sulfuric odor may indicate the presence of hydric soils. Unless prepared to perform a soil analysis, always look for other wetland indicators.

## **Aquatic Organism Passage (AOP) and Connectivity**

“Aquatic Organism Passage” is the ability of aquatic life to migrate upstream and downstream through a stream crossing.

Stream crossing designs or existing conditions that cause barriers to aquatic organism passage include stream crossings that are:

- Undersized,
- Perched,
- Shallow crossings,
- Dams or blockages, or
- Steep Culvert Slopes.

The inability for aquatic life to migrate through a stream crossing may lead to habitat fragmentation. Stream crossing structures that are undersized relative to the natural width and depth of a stream, especially those crossings that do not have natural substrate within them, tend to have high velocities compared to what is typical elsewhere in the stream. These higher velocities reduce aquatic organism passage during periods of high flow, and also often create a scour pool immediately downstream. A scour pool can worsen over time, resulting in a perched condition at the outlet. Perched crossings have outlets that are elevated above the level of the downstream channel. This can occur when the streambed is gradually eroded downstream of the crossing until the end of the culvert is well above the streambed, creating a drop (waterfall) at all but the highest flows. Perching can also result from improper design and/or installation. This condition limits aquatic life passage through the culvert, especially as many aquatic species do not jump. Even without a perch, culverts with shallow water within the structure can restrict aquatic organism passage at low flows. It is important to design crossings large enough to prevent downstream scour and positioned appropriately to maintain connectivity during low flow.

Undersized crossings also restrict natural stream flows, particularly during flood events. This results in high velocities within the structure which fish and other aquatic species cannot negotiate. Other problems involving undersized crossings include increased scouring and erosion as well as clogging and upstream ponding. High velocities may scour the streambed in and downstream of the crossing. They may cause upstream eddying and overtopping of banks. This all degrades habitat for aquatic and other wildlife. It also may result in property loss or damage to infrastructure. Crossings should be large enough to pass aquatic organisms, wildlife, debris and floods. The most common cause of catastrophic culvert failure is the plugging of undersized culverts with debris during flood events. When this occurs, the culvert and road fill act as a dam, ponding water upstream, the water will eventually overtop the road eroding a new channel through or along the roadway.

## **Avoidance and Minimization**

Measures should always be taken to avoid impacts to wetlands, waterways, and sensitive areas. If avoidance is not possible, then the wetland rules require minimization of impacts to the maximum extent practicable. Examples of ways to minimize impacts include:

- Use of alternate access routes or staging areas located outside of jurisdiction.
- Timing work to cause the least impacts (e.g., during the regulatory low-flow period, or when water/ground is frozen).
- Limit the removal of vegetation along the banks of streams and wetlands.
- Limit rip rap apron length to the minimum extent necessary to protect the outlet of the culvert.
- Emulate natural conditions observed in upland and downstream reference reaches.

### **Aquatic Restoration Mapper**

The [Aquatic Restoration Mapper](#) is a web based map that may be used to explore stream crossing data in your community to identify structures that are candidates for replacement to meet the goals of aquatic restoration, infrastructure safety, and flood resiliency. The stream crossing data presented in this mapper has been collected using the New Hampshire Stream Crossing Assessment Protocol and scores for the structure's compatibility with river processes (Geomorphic Compatibility) and overall ability to pass aquatic organisms (AOP). Environmental and biological layers have been included to provide guidance on additional criteria that are often used to determine a culvert's eligibility for funding under several local, state, federal, and non-profit programs.

The New Hampshire Stream Crossing Initiative is an interagency collaboration that manages stream crossing assessment efforts across the state this multiagency collaboration approach enables towns and agencies to efficiently collect, analyze, and distribute stream crossing data to make decisions on structure upgrades and replacements.

The NHDOT recommends that any and all users of the Best Management Practices for Routine Road Maintenance Activities in New Hampshire Manual utilize the Aquatic Restoration Mapper in their planning and environmental consideration for any activity allowed in this manual. The information available in the Aquatic Restoration Mapper is ideal for planning and targeting priority crossings for maintenance/replacement.

### **Timing of Work**

Work should be conducted during the "low flow" period or "in the dry." The U.S. Army Corps of Engineers (US ACOE) regulatory low-flow period is designated as July 15 through October 1.

Careful planning to work during the low-flow period can reduce impacts to surface water and generally avoid spawning and breeding seasons of aquatic organisms. If work must be completed outside of this seasonal window then it must always be under a low flow condition, such that you would normally see during the US ACOE regulatory low-flow time period. This implies a dry stream bed if the resource is an intermittent stream or if the stream is perennial the stream would be at its lowest capacity or diverted with a temporary cofferdam and appropriately sized pump. Work should not be attempted when flows are high due to rainfall runoff or seasonal fluctuations. It is also advised to review weather reports for the length of your project duration to determine if flows may increase due to precipitation events.

In order to minimize stream sedimentation, flow interruption, and disturbance of fish during sensitive

seasons, carefully consider the time and duration of culvert installation and repair. In general, in-stream work should occur during low flow conditions and should be scheduled so that it doesn't coincide with fish migrations, spawning and egg incubation period. Consult with local fish or water resource biologists in order to plan for the best times to avoid fish mating and migration activities in a particular stream.

Work during frozen conditions: Activities conducted once wetland areas are frozen can minimize rutting and other impacts to the surrounding environment. Work during this time also generally reduces the risk of disturbing aquatic and terrestrial wildlife movement by avoiding breeding and nesting seasons. It is difficult to stabilize the area in frozen conditions, which may result in the need for long-term monitoring of the site, particularly as the area begins to thaw and water begins to flow more freely.

## Designated Rivers

A number of rivers throughout the state have been recognized by the New Hampshire legislature as "important natural resources, historically vital to New Hampshire's commerce, industry, and tourism, and the quality of life of New Hampshire people" ([RSA 483](#)). As such, these rivers, designated into the New Hampshire Rivers Management and Protection Program, are afforded additional protections and consideration in order to ensure their continued ecologic and economic value for present and future generations. Each Designated River is overseen by its own Local River Management Advisory Committee (LAC), which advises NHDES and municipalities on matters pertaining to the management of the river and its tributary drainage areas. LACs are required "To consider and comment on any federal, state, or local governmental plans to approve, license, fund or construct facilities, or applications for permits, certificates, or licenses, that may alter the resource values and characteristics for which the river... is designated" (RSA 483:8-a). These facilities include culverts and bridges over, or within ¼-mile of, any designated river.

### How do I know if a project is within ¼-mile of a Designated River?

NHDES has created an interactive online [map of Designated Rivers](#) in New Hampshire. All applicants are required to determine if their project is located within ¼-mile of a Designated River. The map can be found on the Rivers Management and Protection Program page of the NHDES website at <http://des.nh.gov/organization/divisions/water/wmb/rivers/>.

Type in the project address or latitude/longitude coordinates into the search field of the map. The map will zoom in to this location. If any portion of the project falls within the red-shaded corridor along a Designated River, the project is within the protected area of a Designated River.

### What do I do if a project is within ¼ mile of a Designated River?

Some projects within ¼-mile of a Designated River **cannot** be completed under this Manual, and instead require a Wetlands Permit Application. To determine whether a Standard Dredge and Fill application is required, click on the shaded area of the map at the project location. The pop-up box will list the Designated River's classification. Note the classification, and then check **the general criteria for Project Activities**. A measurement tool is included in the upper right corner of the map to help determine the distance of the project from the Designated River. If a Wetlands Permit Application is not required,

follow the requirements outlined for each Routine Roadway Activity for projects near a Designated River, including submitting a copy of the Routine Roadway Notice to the relevant Local River Management Advisory Committee. Contact information for each Committee can be obtained by clicking on the river in the [map of Designated Rivers](#), and following the Contact Information link in the pop-up box.

**Project activities occurring within ¼-mile of a Designated River are expected to implement the following design *recommendations* from Local River Management Advisory Committees:**

- Fully Support Aquatic Organism Passage - Stream crossings are functionally no different than the river/stream channel upstream or downstream of them and aquatic organisms can pass through them effectively.
- Full Geomorphic Compatibility - Stream crossing structures are fully compatible with river channel dimension, pattern, and profile, support river flow and sediment transport processes, and are at low risk of failure.
- Projects are carried out in a way that minimize impacts to riparian buffers and the river's flora, fauna, and water quality.
- Riparian areas disturbed during construction are immediately replanted with native species.
- The hydraulic capacity of replaced culverts is increased to the maximum extent allowed in order to better accommodate flood flows and reduce risk of culvert failure.
- Bank stabilization is done with native vegetation unless proof is provided that vegetative stabilization will not achieve the necessary effect.
- Perched culverts passing perennial streams near Designated Rivers are reconstructed to eliminate the perch. (See the *Special Criteria that apply to Correcting Perched Culverts* in the General Criteria for Project Activities.)

**Natural Heritage Bureau (NHB)**

The New Hampshire Department of Natural and Cultural Resources (DNCR) Natural Heritage Bureau (NHB) finds, tracks and facilitates the protection of New Hampshire's rare plants and exemplary natural communities (types of forests, wetlands, grasslands, etc.). As a bureau within the Division of Forests & Lands, it is fundamentally a service to New Hampshire landowners and land managers. It is not a regulatory agency; instead, it works with landowners and land managers to help protect the State's natural heritage while meeting land-use needs.

The mission of NHB, as mandated by the New Hampshire Native Plant Protection Act of 1987 ([RSA 217-A](#)), is to determine protective measures and requirements necessary for the survival of native plant species in the state, to investigate the condition and degree of rarity of plant species, and to distribute information regarding the condition and protection of these species and their habitats. It also maintains information on rare wildlife in cooperation with the New Hampshire Fish and Game Department's (NHFG) Nongame and Endangered Wildlife Program, which has legal jurisdiction over New Hampshire wildlife.

## When is a NHB data check required?

A NHB data check is required for all Routine Roadway Maintenance Activity Notifications.

NHB, in cooperation with NHDES and NHFG, are in the process of updating the Data Check tool to accommodate Routine Roadway & Railway Maintenance Activities.

Use Notification feature at the following link: [https://www2.des.state.nh.us/nhb\\_datacheck/](https://www2.des.state.nh.us/nhb_datacheck/)

## All project activities, regardless of needing a NHB search, are expected to implement the following recommendations from NHB and NHFG:

### NHFG Recommendations:

- Utilize concrete pipes and/or corrugated metal pipes rather than smooth plastic, when possible. If plastic is the only available alternative, consider the possibility of roughening the interior of the pipe. *(This can improve aquatic passage and reduces flow velocities that may contribute to downstream erosion and stream turbidity.)*
- Utilize coco matting or loose straw (free of invasive species) for slope stabilization rather than other matting types. *(Some types of matting are non-biodegradable and constructed with plastic netting that can sometimes trap and kill snakes and other small species).*
- Minimize vegetation disturbance around riparian zones. *(This can preserve potential sensitive habitat and helps maintain terrestrial connectivity up to and sometimes through the crossings).*
- Upsizing when practicable to improve aquatic passage *(Upsizing an undersized crossing can improve aquatic organism passage and also reduce stream erosion.)*
- Address culvert perches. (See Special Criteria that apply to Perched Culverts in the General Criteria for Project Activities.)
- Carefully consider the time and duration of culvert installation and repair. In general, in-stream work should occur during low-flow conditions and should be scheduled so that it doesn't coincide with fish migrations, spawning and egg incubation period. Consult with local fish or water resource biologists in order to plan for the best times to avoid fish mating and migration activities in a particular stream.

### NHB Recommendations:

- Flag out rare plant populations and/or exemplary natural communities/systems prior to work to minimize impacts. Fence off exemplary natural communities and/or rare native plants adjacent to impact areas as needed to prevent impacts beyond the permitted work zone.
- Provide contractors with site-specific requirements for limiting activities to approved work areas.
- Treat locations of rare native plants as confidential. The identity and precise location of rare species will not be shown on permitting maps, sketches, or photographs available to the public.
- Familiarize crews with the species/communities that will require special consideration and their locations.



- Limit vegetation removal to that necessary for construction of the project. Limit tree clearing to the minimum required width to meet safety clearances, and leave root systems in place, except where other earthwork must be conducted. Leave herbaceous and shrub vegetation intact wherever practicable.
- Any soil used as fill during construction should be free of invasive plant material.
- Use certified weed and invasive-free straw bales for erosion and sediment control.
- Train construction contractors to identify common invasive plant species.
- If invasive species are removed due to construction activity, cut when dormant or prior to seed set, and dispose of appropriately in a manner and location that precludes spread.
- Within sensitive areas, take care during construction to insure that the surficial soil is, to the extent practicable, not compacted. At the conclusion of construction in a particular area, seek to restore the native topsoil that was present prior to construction.
- **Seasonal Avoidance:** Conduct work during times of the year when plants are dormant and/or conditions minimize disturbance of the habitat. Conduct maintenance during frozen-ground conditions to avoid/minimize impacts to exemplary (wetland) natural communities/systems.
- Rare native plants and exemplary natural communities within the right-of-way: Conducting ditch maintenance outside of the growing season or after a plant has produced mature fruit is the preferred way to avoid/minimize impacts to rare plants.
- If seasonal avoidance is not possible, flag rare plant populations within the work area to avoid impacts.
- Work may need to be done by hand in the vicinity of rare plant species to minimize impacts.
- Consider alternate forms of access when the work area is in the vicinity of a threatened or endangered plant, or an exemplary natural community/system. For example, if a site may be accessed from two different directions, select the approach that is least likely to change local hydrology or cause direct damage (plan routes to avoid a local concentration of rare plant species).
- Use coco matting. Avoid using timber matting on top of rare plants during the growing season and flag any known rare plant populations prior to applying matting. Use loose weed free straw.
- Avoid placing BMPs (i.e., silt fence, coir logs, swamp mats, corduroy, swamp mat bridges, poled fords, culverts, rock fords, turbidity curtains, erosion control blankets, etc.) within, or in such a way that they would negatively affect rare plant populations.
- If project-related soil disturbance occurs in the vicinity of rare plants or exemplary natural communities/systems, the disturbed area should be allowed to re-vegetate naturally to prevent competition from introduced, fast-growing or invasive species.
- Any seed mix proposed to be used near known locations of rare plants or exemplary natural communities/systems should contain only non-aggressive and non-invasive plant species (ideally those that are native). Any species that form dense mats, shade out, grow on top of, or would otherwise out-compete the native vegetation within the sensitive area should not be used.
- Fertilizers and pH balancers should not be used in areas with rare plants or exemplary natural communities/systems, as these sensitive natural features often have unique soil chemistry

requirements. Changing the soil chemistry of sensitive areas can eliminate populations of rare plants plant species of cause a transition to a different plant community.

- Any mulch used in the vicinity of rare plants or exemplary natural communities/systems should be free of invasive plant seeds or fragments. Contact NHB before applying mulch in these areas.
- Take particular care to avoid introducing invasive plant species to areas with rare plants or exemplary natural communities/systems. Ensure that any equipment, tools, footwear and clothing are clean prior to entering a sensitive area.

## **Invasive Species**

An invasive plant is a non-native plant that is able to persist and proliferate outside of cultivation, resulting in ecological and/or economic harm. All invasive plant species are aggressive competitors with the ability to significantly reduce diversity of native plant and animal species. The land adjacent to roadways tends to be ideal habitat for invasive plants because of its high level of disturbance and abundant sunlight.

NHDOT has developed Best Management Practices (BMPs) to address mounting concerns over invasive plants and the role roadway maintenance activities play in the spread of these plants along roadsides. Best Management Practices (BMPs) have been developed and the implementation of these BMPs will help prevent the spread of invasive plants caused by maintenance and construction activities. All activities undertaken using this manual must also comply with the [Best Management Practices for the Control of Invasive and Noxious Plant Species \(2018\) Manual](#).

A copy of the New Hampshire Invasive Species Committee's, [New Hampshire Invasive Prohibited Plant Species List](#), approved by the ISA March 17, 2016, is available in the appendices.

## **Construction**

### **Pre-Construction and Daily Coordination Briefings**

It is recommended that regular communication and coordination occur between individuals who designed the project and those who will be conducting the work prior to the commencement of all work. It is important to appoint responsible parties, discuss timing of work, and further consider options to avoid and/or minimize impacts to sensitive areas. These meetings are important to review details of plans and conditions of the project. Regular meetings keep everyone up to date, confirm there is consensus on work methods and responsibilities, and ensure that tasks are being fulfilled with as little cost and impact to the environment as possible.

# General Criteria for Project Activities

## Criteria that Apply to All Project Activities:

- The activity would not qualify for this process if it impacts any of the following resources or conditions:
  - Bog.
  - Exemplary Natural Community/S1 or S2 as designated by NHB.
  - Sand dune, flat or tidal wetland or Undisturbed Tidal Buffer Zone.
  - In or within 100 ft. (See the list of towns in appendix with 100-foot setback) of a designated prime wetland.
  - Tier 3 Stream (Exceptions Activities RR5 and RR9).
  - Designated Rivers: An activity will not qualify for the Routine Roadway Notification process if within 250 feet of a Designated River.
    - Exception 1: If the activity is located on a Tier 1 stream.
    - Exception 2: If the structure does not convey a direct surface water or hydrologic connection to the Designated River.
  - **NOTE: If the work is within ¼-mile of any Designated River, a copy of the Routine Roadway Notice must be submitted to the River’s Local Advisory Committee a minimum of five days prior to the start of work.**
  - If “**High Bank Erosion**” exists, where erosion processes have scoured the toe of the stream bank to an extent that the upper portion of the stream bank has collapsed within 150 linear feet of the crossing.
- The project may not direct new flows into the structure or resource, nor may sources of untreated stormwater be introduced into the structures or resources; examples include but are not limited to new swales, catch basins or underdrains.
- Any culvert crossing that has a history of causing or contributing to flooding may not be replaced using this process.
- The culvert or culverts have a combined opening up to 48 inches in diameter (or 12.5 square feet) and shall not be on a Tier 3 stream, where the watershed above a stream crossing is 640 acres or greater in size. (Exempting Activities 5.0, and 9.0)
- If a rare, endangered or threatened species are identified as possibly being impacted by the project, then the proposed activity shall implement any comments or recommendations from NHB or NHFG in regards to threatened and endangered species ([NHB Section](#) of this manual).
- The existing structures must be considered legal, either through previous permitting or the structure would be **grandfathered**, and has not been **abandoned**.
- The proposed work shall be done during low water periods and “in the dry,” when the resource is not flowing or behind temporary diversions as depicted in this manual if necessary.

### Criteria that Apply to ALL Stream Activities:

- Any stream crossing shall be designed and constructed to improve sediment transport, **or if that is not practicable**, the new crossing shall at least **maintain** the sediment transport capacity of the original crossing.
- Any stream crossing shall be designed and constructed so as to not restrict high flows and to consider downstream infrastructure.
- Any stream crossing shall maintain the existing low flows.
- Any stream activity shall be designed and constructed to not increase in the frequency of flooding or overtopping the banks.
- Any stream activity shall not cause erosion, aggradation or **scouring** upstream or downstream of the crossing and not cause water quality degradation.
- The activity shall not diminish the **hydraulic capacity** of the crossing or the ability of the crossing to accommodate **aquatic organism passage**.

### Special Criteria that apply to Correcting Perched Culverts:

- A Professional Engineer shall design and approve any activity to a culvert any time the slope of a culvert changes in order to match the inlet and outlet elevation of the existing stream bed.
- The height of the distance to be corrected between the stream bed and the culvert invert shall not exceed one foot.
- The slope of the culvert to correct the perch shall not exceed 5%, unless the natural stream slope is greater than 5% in an undisturbed reach.
- The impacts associated with the activity shall not exceed 50 feet in length of impact, including any outlet protection aprons.
- The activity sponsor shall monitor the site one calendar year from the date of completion to ensure no further erosion has occurred.
- The applicant shall provide photo documentation of the inlet, outlet, a view upstream, and a view downstream. This shall be done each quarter for one year after the project has been completed. This information shall be submitted to the NHDES file number within two weeks of the photo date.
- If the original problem or a new problem is observed in the monitoring period the applicant shall provide a Standard Dredge and Fill Application: with proposed long term solutions to the problem.

**Project Activities that Qualify for the Routine Roadway  
Notification Process/Activity Sketches**

### **Activity Sketches**

These sketches have been developed for your convenience and to streamline the permitting process. You are not required to use these pre-developed sketches but you must provide a sketch with all the information shown on these sketches with your Routine Roadway notification form. Please be sure to fill out all of the requested information or, if you are providing your own sketch, include all of the information found on these sketches for your project.

### **For Multi Activity Sketches:**

These sketches have been developed for your convenience when the project proposes one or more qualifying activities. It is not mandatory to have all of the activities on these sketches as part of your project. Simply indicate which of the activities you will be doing as part of your project and fill all the pertinent information for the activity on the sketch.

## **General Conditions that apply to All Routine Roadway and Railway Maintenance**

### **Activities:**

1. Appropriate siltation/erosion controls shall be in place prior to any excavation, shall be maintained during construction, and remain until the area is stabilized.
2. Work shall be done with the equipment located outside of surface waters or wetlands, and at no time shall equipment be staged in the water. The contractor shall avoid locating equipment on jurisdictional bank, except when no other non-jurisdictional work areas are available to complete the work.
3. Work shall be done during the low flow time of the year and must be done in the dry. Work in the dry can be achieved by installation of by-pass system, or when the resource is not flowing.  
(Excluding Activity RR-9)
4. Discharge from dewatering of work areas shall be to sediment basins that are: a) located in uplands b) have an acceptable sediment trapping liner and c) have a 50-foot vegetated buffer, if possible, and in all cases have a minimum of 20 feet of undisturbed vegetated buffer. (Excluding Activity RR-9)
5. Dredged materials, whether to be stockpiled or disposed of, shall be dewatered in sedimentation basins lined with siltation and erosion controls, and located outside of areas subject to RSA 482-A jurisdiction. (Excluding Activity RR-9)
6. Dredged materials shall be placed outside of the jurisdiction of the NHDES Wetlands Bureau.
7. Within three days of final grading or temporary suspension of work in an area that is in or adjacent to wetlands or surface waters, all exposed soil areas shall be stabilized by seeding and mulching during the growing season, or if not within the growing season, by mulching with tackifiers. Stabilization shall include mulching with tackifiers on slopes less than 3:1 or netting and pinning on slopes steeper than 3:1.
8. Channel matting and seeding shall be installed within all disturbed soil areas along watercourses prior to receiving flow.
9. Siltation and erosion controls must be removed once the area is stabilized.

## Activity RR-1: Culvert Replacement or Repair

**Activity Description:** Replacement of a culvert or culverts that have been damaged and/or are no longer able to perform its intended function.

**Recommended BMPs:** 1, 2, 3, 4, 6, 7, 8, 9, 11, 12, 13, 14.

**In addition to the General Criteria for Project Activities on pages 18 and 19, the following shall apply:**

### Activity-Specific Criteria:

- The culvert or culverts have a combined opening up to 48 inches in diameter (or 12.5 square feet).
- Work shall be done with the equipment located outside of surface waters or wetlands.
- There is no change in the location, configuration or length of the pre-existing culvert in single culvert crossings.
- There is no change in the location, or length of a multiple culvert crossing. However, if it is practicable any multi-culvert crossings shall be replaced as single culvert crossings with an equal or greater functional hydraulic opening up to a single 48-inch culvert (or 12.5 sq. ft.). The opening of the replacement culvert may be increased 50% up to the equivalent of a single 48-inch diameter culvert or the functional equivalent hydraulic opening (12.5 sq. ft.)
- Designated Rivers: An activity will not qualify for the Routine Roadway Notification process if within 250 feet of a Designated River.  
Exception 1: If the activity is located on a Tier 1 stream whose contributing watershed above the stream crossing is 200 acres or smaller.  
Exception 2: If the structure does not convey a direct surface water connection to the Designated River.  
**NOTE: If the work is within ¼-mile of any Designated River, a copy of the Routine Roadway Notice must be submitted to the River's Local Advisory Committee a minimum of five days prior to the start of work.**
- *To qualify for the Certified Culvert Maintainer Program the project must not be within ¼-mile of a Designated River or segment of river designated under RSA-483.*

### General Conditions:

1. Appropriate siltation/erosion controls shall be in place prior to any excavation, shall be maintained during construction, and remain until the area is stabilized.
2. Work shall be done with the equipment located outside of surface waters or wetlands, and at no time shall equipment be staged in the water. The contractor shall avoid locating equipment on jurisdictional bank, except when no other non-jurisdictional work areas are available to complete the work.
3. Work shall be done during the low flow time of the year and must be done in the dry. Work in the dry can be achieved by installation of by-pass system, or when the resource is not flowing.
4. Discharge from dewatering of work areas shall be to sediment basins that are: a) located in uplands b) have an acceptable sediment trapping liner and c) have a 50-foot vegetated buffer, if possible, and in all cases have a minimum of 20 feet of undisturbed vegetated buffer.
5. Dredged materials, whether to be stockpiled or disposed of, shall be dewatered in sedimentation basins lined with siltation and erosion controls, and located outside of areas subject to RSA 482-A jurisdiction.
6. Dredged materials shall be placed outside of the jurisdiction of the NHDES Wetlands Bureau.
7. Within three days of final grading or temporary suspension of work in an area that is in or adjacent to wetlands or surface waters, all exposed soil areas shall be stabilized by seeding and mulching during the growing season, or if not within the growing season, by mulching with tackifiers. Stabilization shall include mulching with tackifiers on slopes less than 3:1 or netting and pinning on slopes steeper than 3:1.
8. Channel matting and seeding shall be installed within all disturbed soil areas along watercourses prior to receiving flow.
9. Siltation and erosion controls must be removed once the area is stabilized.

### Activity Specific Conditions:

10. There is no change in the location, configuration or length of the pre-existing culvert.
11. The replacement culvert shall preserve watercourse connectivity where it currently exists.
12. The replacement culvert shall restore watercourse connectivity where connectivity was previously disrupted as a result of human activity(ies); and restoration of connectivity will benefit aquatic life upstream or downstream of the crossing or both.



## Activity RR-2: Culvert Extension

**Activity Description:** Extension of a culvert or culverts up to 10 feet at the inlet and the outlet for various safety reasons including roadway widening, slope stabilization, guardrail installation or safety lanes on a public roadway.

In addition to the General Criteria for Project Activities on pages 18 and 19, the following shall apply:

Recommended BMPs: 1, 2, 3, 4, 6, 7, 8, 9, 11, 12, 13, 14.

### Activity-Specific Criteria:

- The culvert or culverts have a combined opening up to 48 inches in diameter (or 12.5 square feet).
- The work must be located on a publicly maintained roadway, public property, or easement held by the state or a municipality.
- Work shall be done with the equipment located outside of surface waters or wetlands.
- The culvert or culverts have not been extended using this process previously.
- If it is practicable any multi-culvert crossings shall be replaced as single culvert crossings with an equal or greater functional hydraulic opening up to a single, 48-inch culvert (or 12.5 sq. ft.).
- The proposed work may be a culvert extension to an existing pipe or a complete replacement of the pipe with the extension.
- The opening of the replacement culvert may be increased 50% up to the equivalent of a single 48-inch diameter culvert or the functional equivalent hydraulic opening (12.5 sq. ft.).
- Designated Rivers: An activity will not qualify for the Routine Roadway Notification process if within 250 feet of a Designated River.  
Exception 1: If the activity is located on a Tier 1 stream whose contributing watershed above the stream is 200 acres or smaller.

Exception 2: If the structure does not convey a direct surface water connection to the Designated River.

**NOTE: If the work is within ¼-mile of any Designated River, a copy of the Routine Roadway Notice must be submitted to the River's Local Advisory Committee a minimum of five days prior to the start of work.**

- *To qualify for the Certified Culvert Maintainer Program the project must not be within a ¼-mile of a Designated River or segment of river designated under RSA-483.*

### General Conditions:

1. Appropriate siltation/erosion controls shall be in place prior to any excavation, shall be maintained during construction, and remain until the area is stabilized.
2. Work shall be done with the equipment located outside of surface waters or wetlands, and at no time shall equipment be staged in the water. The contractor shall avoid locating equipment on jurisdictional bank, except when no other non-jurisdictional work areas are available to complete the work.
3. Work shall be done at the low flow time of the year and must be done in the dry. Work in the dry can be achieved by installation of by-pass system, or when the resource is not flowing.
4. Discharge from dewatering of work areas shall be to sediment basins that are: a) located in uplands b) have an acceptable sediment trapping liner and c) have a 50-foot vegetated buffer if possible and in all cases have a minimum of 20 feet of undisturbed vegetated buffer.
5. Dredged materials, whether to be stockpiled or disposed of, shall be dewatered in sedimentation basins lined with siltation and erosion controls, and located outside of areas subject to RSA 482-A jurisdiction.
6. Dredged materials shall be placed outside of the jurisdiction of the NHDES Wetlands Bureau.
7. Within three days of final grading or temporary suspension of work in an area that is in or adjacent to wetlands or surface waters, all exposed soil areas shall be stabilized by seeding and mulching during the growing season, or if not within the growing season, by mulching with tackifiers. Stabilization shall include mulching with tackifiers on slopes less than 3:1 or netting and pinning on slopes steeper than 3:1.
8. Channel matting and seeding shall be installed within all disturbed soil areas along watercourses prior to receiving flow.
9. Siltation and erosion controls must be removed once the area is stabilized.

### Activity Specific Conditions:

10. The replacement culvert shall preserve watercourse connectivity where it currently exists.
11. The replacement culvert shall restore watercourse connectivity where connectivity was previously disrupted as a result of human activity(ies); and Restoration of connectivity will benefit aquatic life upstream or downstream of the crossing or both.

## Activity RR-3: Culvert Relocation

**Activity Description:** Replacement and/or relocation of a culvert or multiple culverts, on an intermittent stream to prevent erosion, provide better drainage control and/or improve hydrologic connectivity through an intersection.

**Recommended BMPs:** 1, 2, 3, 4, 6, 7, 8, 9, 11, 12, 13, 14.

**In addition to the General Criteria for Project Activities on pages 18 and 19, the following shall apply:**

### Activity-Specific Criteria:

- The culvert or culverts have a combined opening up to 48 inches in diameter (or 12.5 square feet).
- The crossing is an intermittent stream. The crossing may not be a perennial stream.
- The work must be located on a publicly maintained roadway, public property, or easement held by the state or a municipality.
- Work shall be done with the equipment located outside of surface waters or wetlands.
- Neither the relocated (skewed) inlet nor outlet (nor the sum of their differences) is greater than 50 feet from their original locations.
- The total length of streambed channel that is to be impacted (filled/abandoned and any proposed scour protection at the culvert inlet and outlet) must be less than 50 linear feet.
- If it is practicable any multi-culvert crossings shall be replaced as single culvert crossings with an equal or greater functional hydraulic opening up to a single 48-inch culvert (or 12.5 sq. ft.).
- If both the inlet and outlet are relocated (skewed), their elevations shall be at the pre-existing stream bed elevation at both the inlet and the outlet.
- The opening of the replacement culvert may be increased 50% up to the equivalent of a single 48-inch diameter culvert or the functional equivalent hydraulic opening (12.5 sq. ft.).
- Designated Rivers: An activity will not qualify for the Routine Roadway Notification process if within 250 feet' of a Designated River. Exception 1: If the activity is located on a Tier 1 stream whose contributing watershed above the stream is 200 acres or smaller. Exception 2: If the structure does not convey a direct surface water connection to the Designated River.

**NOTE: If the work is within ¼-mile of any Designated River, a copy of the Routine Roadway Notice must be submitted to the River's Local Advisory Committee a minimum of five days prior to the start of work.**

- *To qualify for the Certified Culvert Maintainer Program the project must not be within a ¼-mile of a Designated River or segment of river designated under RSA-483.*

### General Conditions:

1. Appropriate siltation/erosion controls shall be in place prior to any excavation, shall be maintained during construction, and remain until the area is stabilized.
2. Work shall be done with the equipment located outside of surface waters or wetlands, and at no time shall equipment be staged in the water. The contractor shall avoid locating equipment on jurisdictional Bank, except when no other non-jurisdictional work areas are available to complete the work.
3. Work shall be done at the low flow time of the year and must be done in the dry. Work in the dry can be achieved by installation of by-pass system, or when the resource is not flowing.
4. Discharge from dewatering of work areas shall be to sediment basins that are: a) located in uplands b) have an acceptable sediment trapping liner and c) have a 50-foot vegetated buffer if possible and in all cases have a minimum of 20 feet of undisturbed vegetated buffer.
5. Dredged materials, whether to be stockpiled or disposed of, shall be dewatered in sedimentation basins lined with siltation and erosion controls, and located outside of areas subject to RSA 482-A jurisdiction.
6. Dredged materials shall be placed outside of the jurisdiction of the NHDES Wetlands Bureau.
7. Within three days of final grading or temporary suspension of work in an area that is in or adjacent to wetlands or surface waters, all exposed soil areas shall be stabilized by seeding and mulching during the growing season, or if not within the growing season, by mulching with tackifiers. Stabilization shall include mulching with tackifiers on slopes less than 3:1 or netting and pinning on slopes steeper than 3:1.
8. Channel matting and seeding shall be installed within all disturbed soil areas along watercourses prior to receiving flow.
9. Siltation and erosion controls must be removed once the area is stabilized.

### Activity Specific Conditions:

10. The impacted resource is an intermittent stream.
11. The inlet and outlet elevations for the culvert shall be set at the same elevation as the pre-construction stream bed.
12. The total length of streambed channel impacted is less than 50 linear feet including any scour protection.

## Activity RR-4: Embankment Stabilization

**Activity Description:** Installation of stone rip-rap, humus and seed to restore an eroded roadway embankment adjacent to an intermittent stream or a wetland.

**Recommended BMPs:** 1, 2, 3, 5, 10, 11, 12, 13, 14

**In addition to the General Criteria for Project Activities on pages 18 and 19, the following shall apply:**

### Activity-Specific Criteria:

- The work shall be done only on intermittent streams or wetlands.
  - The work must be located on a publicly maintained roadway, public property, or easement held by the state or a municipality.
  - Work shall be done with the equipment located outside of surface waters or wetlands.
  - The proposed work area shall be less than 50 feet along the bank and the height of the work area shall be limited to what can be reached from outside of wetlands jurisdiction.
  - If rip-rap stone is used, loam and vegetation shall be planted over the stone or within the interstitial spaces to promote shading and/or treatment.
  - Designated Rivers: An activity will not qualify for the Routine Roadway Notification process if within 250 feet of a Designated River.  
Exception 1: If the activity is located on a Tier 1 stream whose contributing watershed above the stream crossing is 200 acres or smaller.  
Exception 2: If the structure does not convey a direct surface water connection to the Designated River.
- NOTE: If the work is within mile of any Designated River, a copy of the Routine Roadway Notice must be submitted to the River's Local Advisory Committee a minimum of five days prior to the start of work.**
- *This activity does not qualify for the Certified Culvert Maintainer Program.*

### General Conditions:

1. Appropriate siltation/erosion controls shall be in place prior to any excavation, shall be maintained during construction, and remain until the area is stabilized.
2. Work shall be done with the equipment located outside of surface waters or wetlands, and at no time shall equipment be staged in the water. The contractor shall avoid locating equipment on jurisdictional bank, except when no other non-jurisdictional work areas are available to complete the work.
3. Work shall be done at the low flow time of the year and must be done in the dry. Work in the dry can be achieved by installation of by-pass system, or when the resource is not flowing.
4. Discharge from dewatering of work areas shall be to sediment basins that are: a) located in uplands b) have an acceptable sediment trapping liner and c) have a 50-foot vegetated buffer if possible and in all cases have a minimum of 20 feet of undisturbed vegetated buffer.
5. Dredged materials, whether to be stockpiled or disposed of, shall be dewatered in sedimentation basins lined with siltation and erosion controls, and located outside of areas subject to RSA 482-A jurisdiction.
6. Dredged materials shall be placed outside of the jurisdiction of the NHDES Wetlands Bureau.
7. Within three days of final grading or temporary suspension of work in an area that is in or adjacent to wetlands or surface waters, all exposed soil areas shall be stabilized by seeding and mulching during the growing season, or if not within the growing season, by mulching with tackifiers. Stabilization shall include mulching with tackifiers on slopes less than 3:1 or netting and pinning on slopes steeper than 3:1.
8. Channel matting and seeding shall be installed within all disturbed soil areas along watercourses prior to receiving flow.
9. Siltation and erosion controls must be removed once the area is stabilized.

### Activity Specific Conditions:

10. The resource must be an intermittent stream or wetland, which is not a marsh or surface water
11. The work area shall be 50 linear feet or less along the bank of the intermittent stream.
12. Rip rap stone shall be properly sized, by a qualified professional.
13. Rip rap stone shall be properly keyed into the toe of the slope.
14. If a stream channel exists no dredging or fill within the channel is permitted.
15. Rip rap stone shall be covered with loam or humus and planted with appropriate species to promote shading and treatment.

## Activity RR-5: IN-KIND Headwall Repair Only, on Any Size Culvert

**Activity Description:** IN KIND repair only, of an existing headwall on any size structure. (This activity does not allow replacement or reconstruction of an existing headwall. The intended use of this activity is to allow the ability for superficial repairs such as, but not limited to re-pointing, re-facing, crack sealing, joint repairs, etc. to an existing headwall of any size. If you need to replace or reconstruct a headwall refer to activity RR-6).

**Recommended BMPs:** 1, 2, 3, 4, 6, 7, 8, 9, 11, 12, 13, 14.

In addition to the General Criteria for Project Activities on pages 18 and 19, the following shall apply:

### Activity-Specific Criteria:

- The work is on any size stream, but only involves headwall repair in the dry.
- The work must be located on a publicly maintained roadway, public property, or easement held by the state or a municipality.
- Work shall be done with the equipment located outside of surface waters or wetlands.
- The existing stream crossing shall not have any "high bank erosion."
- The existing stream crossing must accommodate aquatic organism passage.
- The existing stream crossing shall accommodate low flow.
- The existing stream crossing does not overtop at the 50-year storm event.
- There are no new permanent impacts associated with the proposed work.
- Designated Rivers: An activity will not qualify for the Routine Roadway Notification process if within 250 feet of a Designated River. Exception 1: If the activity is located on a Tier 1 stream whose contributing watershed above the stream crossing is 200 acres or smaller. Exception 2: If the structure does not convey a direct surface water connection to the Designated River. **NOTE: If the work is within ¼-mile of any Designated River, a copy of the Routine Roadway Notice must be submitted to the River's Local Advisory Committee a minimum of five days prior to the start of work.**
- *This activity does not qualify for the Certified Culvert Maintainer Program.*

### General Conditions:

1. Appropriate siltation/erosion controls shall be in place prior to any excavation, shall be maintained during construction, and remain until the area is stabilized.
2. Work shall be done with the equipment located outside of surface waters or wetlands, and at no time shall equipment be staged in the water. The contractor shall avoid locating equipment on Jurisdictional Bank, except when no other non-jurisdictional work areas are available to complete the work.
3. Work shall be done at the low flow time of the year and must be done in the dry. Work in the dry can be achieved by installation of by-pass system, or when the resource is not flowing.
4. Discharge from dewatering of work areas shall be to sediment basins that are: a) located in uplands b) have an acceptable sediment trapping liner and c) have a 50-foot vegetated buffer if possible and in all cases have a minimum of 20 feet of undisturbed vegetated buffer.
5. Dredged materials, whether to be stockpiled or disposed of, shall be dewatered in sedimentation basins lined with siltation and erosion controls, and located outside of areas subject to RSA 482-A jurisdiction.
6. Dredged materials shall be placed outside of the jurisdiction of the NHDES Wetlands Bureau.
7. Within three days of final grading or temporary suspension of work in an area that is in or adjacent to wetlands or surface waters, all exposed soil areas shall be stabilized by seeding and mulching during the growing season, or if not within the growing season, by mulching with tackifiers. Stabilization shall include mulching with tackifiers on slopes less than 3:1 or netting and pinning on slopes steeper than 3:1.
8. Channel matting and seeding shall be installed within all disturbed soil areas along watercourses prior to receiving flow.
9. Siltation and erosion controls must be removed once the area is stabilized.

### Activity-Specific Conditions:

10. Extreme precautions shall be taken within riparian areas to limit removal of vegetation and areas cleared of vegetation shall be re-vegetated within three days of the completion of the project with like native species
11. All work conducted behind an in stream diversion shall be completed within five consecutive working days.
12. There shall be no more than 10 linear feet (per bank) of temporary bank disturbance, running parallel with the stream, associated with accessing the work area. All temporary impacts shall be restored upon completion of work.

## Activity RR-6: Headwall Construction, Repair or Replacement

**Activity Description:** Construction, repair or replacement, of a headwall on a culvert with less than a 48-inch diameter opening (or 12.5 square feet).

**Recommended BMPs:** 1, 2, 3, 4, 6, 7, 8, 9, 11, 12, 13, 14.

**In addition to the General Criteria for Project Activities on pages 18 and 19, the following shall apply:**

### Activity Specific Criteria:

- The culvert or culverts have a combined opening up to 48-inches in diameter (or 12.5 square feet).
- Work shall be done with the equipment located outside of surface waters or wetlands.
- Work can be done in combination with the replacement or extension of the culvert if the project also qualifies for those activities.
- Designated Rivers: An activity will not qualify for the Routine Roadway Notification process if within 250 feet of a Designated River.  
Exception 1: If the activity is located on a Tier 1 stream whose contributing watershed above the stream crossing is 200 acres or smaller.  
Exception 2: If the structure does not convey a direct surface water connection to the Designated River.  
**NOTE: If the work is within ¼-mile of any Designated River, a copy of the Routine Roadway Notice must be submitted to the River's Local Advisory Committee a minimum of five days prior to the start of work.**
- *To qualify for the Certified Culvert Maintainer Program the project must not be within a ¼-mile of a Designated River or segment of river designated under RSA-483.*

### General Conditions:

1. Appropriate siltation/erosion controls shall be in place prior to any excavation, shall be maintained during construction, and remain until the area is stabilized.
2. Work shall be done with the equipment located outside of surface waters or wetlands, and at no time shall equipment be staged in the water. The contractor shall avoid locating equipment on jurisdictional bank, except when no other non-jurisdictional work areas are available to complete the work.
3. Work shall be done at the low flow time of the year and must be done in the dry. Work in the dry can be achieved by installation of by-pass system, or when the resource is not flowing.
4. Discharge from dewatering of work areas shall be to sediment basins that are: a) located in uplands b) have an acceptable sediment trapping liner and c) have a 50-foot vegetated buffer if possible and in all cases have a minimum of 20 feet of undisturbed vegetated buffer.
5. Dredged materials, whether to be stockpiled or disposed of, shall be dewatered in sedimentation basins lined with siltation and erosion controls, and located outside of areas subject to RSA 482-A jurisdiction.
6. Dredged materials shall be placed outside of the jurisdiction of the NHDES Wetlands Bureau.
7. Within three days of final grading or temporary suspension of work in an area that is in or adjacent to wetlands or surface waters, all exposed soil areas shall be stabilized by seeding and mulching during the growing season, or if not within the growing season, by mulching with tackifiers. Stabilization shall include mulching with tackifiers on slopes less than 3:1 or netting and pinning on slopes steeper than 3:1.
8. Channel matting and seeding shall be installed within all disturbed soil areas along watercourses prior to receiving flow.
9. Siltation and erosion controls must be removed once the area is stabilized.

### Activity-Specific Conditions:

10. Extreme precautions shall be taken within riparian areas to limit removal of vegetation and areas cleared of vegetation shall be re-vegetated within three days of the completion of the project with like native species.
11. There shall be no more than 10 linear feet of temporary bank disturbance, running parallel with the stream, **associated with accessing the work area**. All temporary impacts shall be restored upon completion of work.
12. There shall be no more than 10 linear feet (per bank) of permanent bank disturbance, running parallel with the stream, **associated with new headwall/wingwall extensions**.

## Activity RR-7: Roadside Ditch Maintenance

**Activity Description:** Dredging of manmade roadside drainage ditches running parallel to the road carrying an intermittent stream limited to 50 linear feet and/or limited to a total impact area no greater than 3,000 square feet (whichever comes first). *This activity is intended to allow minimum maintenance type dredging along a manmade ditch carrying an intermittent stream that does not qualify for the manmade ditch maintenance exemption under RSA 482-A:3 IV(b).*

**Recommended BMPs:** 1, 2, 3, 5, 11, 13, 14.

In addition to the General Criteria for Project Activities on pages 18 and 19, the following shall apply:

### Activity Specific Criteria:

- The ditch must be manmade and not have been abandoned with defined channel and banks.
- The ditch must not carry a perennial stream.
- The ditch must run parallel or nearly parallel to the roadway.
- The ditch maintenance may not be more than 50 feet in length along the stream channel or total work cannot impact greater than 3,000 square feet.
- All work shall be done in low flow where no flow is within the ditch.
- The ditch length, width, and height shall be dredged back to its original dimensions, no modifications are allowed.
- Designated Rivers: An activity will not qualify for the Routine Roadway Notification process if within 250 feet of a Designated River.

Exception 1: If the activity is located on a Tier 1 stream whose contributing watershed above the stream crossing is 200 acres or smaller.

Exception 2: If the structure does not convey a direct surface water connection to the Designated River.

**NOTE: If the work is within ¼-mile of any Designated River, a copy of the Routine Roadway Notice must be submitted to the River's Local Advisory Committee a minimum of five days prior to the start of work.**

- *This activity does not qualify for the Certified Culvert Maintainer Program.*

### General Conditions:

1. Appropriate siltation/erosion controls shall be in place prior to any excavation, shall be maintained during construction, and remain until the area is stabilized.
2. Work shall be done with the equipment located outside of surface waters or wetlands, and at no time shall equipment be staged in the water. The contractor shall avoid locating equipment on jurisdictional bank, except when no other non-jurisdictional work areas are available to complete the work.
3. Work shall be done at the low flow time of the year and must be done in the dry. Work in the dry can be achieved by installation of by-pass system, or when the resource is not flowing.
4. Discharge from dewatering of work areas shall be to sediment basins that are: a) located in uplands b) have an acceptable sediment trapping liner and c) have a 50-foot vegetated buffer if possible and in all cases have a minimum of 20 feet of undisturbed vegetated buffer.
5. Dredged materials, whether to be stockpiled or disposed of, shall be dewatered in sedimentation basins lined with siltation and erosion controls, and located outside of areas subject to RSA 482-A jurisdiction.
6. Dredged materials shall be placed outside of the jurisdiction of the NHDES Wetlands Bureau.
7. Within three days of final grading or temporary suspension of work in an area that is in or adjacent to wetlands or surface waters, all exposed soil areas shall be stabilized by seeding and mulching during the growing season, or if not within the growing season, by mulching with tackifiers. Stabilization shall include mulching with tackifiers on slopes less than 3:1 or netting and pinning on slopes steeper than 3:1.
8. Channel matting and seeding shall be installed within all disturbed soil areas along watercourses prior to receiving flow.
9. Siltation and erosion controls must be removed once the area is stabilized.

### Activity Specific Conditions:

10. No more than 50 linear feet of ditch shall be disturbed by the project.
11. Extreme precautions shall be taken within riparian areas to limit removal of vegetation and areas cleared of vegetation shall be re-vegetated within three days of the completion of the project with like native species.
12. Stone rip rap shall not be installed within the ditch if it was not previously present.

## Activity RR-8: Culvert Inlet and Outlet Maintenance

**Activity Description:** Removal of accumulated sediment or debris at culvert inlets and outlets that impede flow through the culvert.

**Recommended BMPs:** 1, 2, 4, 5, 6, 7, 8, 9, 13, 14.

**In addition to the General Criteria for Project Activities on pages 18 and 19, the following shall apply:**

### Activity-Specific Criteria:

- The culvert or culverts have a combined opening up to 48 inches in diameter (or 12.5 square feet).
- Work shall be done with the equipment located outside of surface waters or wetlands.
- The culvert may not be perched and the removal of the material may not make the culvert perched.
- Work shall not extend beyond 20 feet from the culvert inlet or outlet.
- The work may not change the slope of the stream bed and must match the existing stream bed elevation.
- The material removed must be obstructing or diverting flows and shall not be original streambed material.
- Designated Rivers: An activity will not qualify for the Routine Roadway Notification process if within 250 feet of a Designated River.

Exception 1: If the activity is located on a Tier 1 stream whose contributing watershed above the stream crossing is 200 acres or smaller.

Exception 2: If the structure does not convey a direct surface water connection to the Designated River.

**NOTE: If the work is within ¼-mile of any Designated River, a copy of the Routine Roadway Notice must be submitted to the River's Local Advisory Committee a minimum of five days prior to the start of work.**

- *To qualify for the Certified Culvert Maintainer Program the project must not be within a ¼-mile of a Designated River or segment of river designated under RSA-483.*

### General Conditions:

1. Appropriate siltation/erosion controls shall be in place prior to any excavation, shall be maintained during construction, and remain until the area is stabilized.
2. Work shall be done with the equipment located outside of surface waters or wetlands, and at no time shall equipment be staged in the water. The contractor shall avoid locating equipment on jurisdictional bank, except when no other non-jurisdictional work areas are available to complete the work.
3. Work shall be done at the low flow time of the year and must be done in the dry. Work in the dry can be achieved by installation of by-pass system, or when the resource is not flowing.
4. Discharge from dewatering of work areas shall be to sediment basins that are: a) located in uplands b) have an acceptable sediment trapping liner and c) have a 50-foot vegetated buffer if possible and in all cases have a minimum of 20 feet of undisturbed vegetated buffer.
5. Dredged materials, whether to be stockpiled or disposed of, shall be dewatered in sedimentation basins lined with siltation and erosion controls, and located outside of areas subject to RSA 482-A jurisdiction.
6. Dredged materials shall be placed outside of the jurisdiction of the NHDES Wetlands Bureau.
7. Within three days of final grading or temporary suspension of work in an area that is in or adjacent to wetlands or surface waters, all exposed soil areas shall be stabilized by seeding and mulching during the growing season, or if not within the growing season, by mulching with tackifiers. Stabilization shall include mulching with tackifiers on slopes less than 3:1 or netting and pinning on slopes steeper than 3:1.
8. Channel matting and seeding shall be installed within all disturbed soil areas along watercourses prior to receiving flow.
9. Siltation and erosion controls must be removed once the area is stabilized.

### Activity-Specific Conditions:

10. Maintenance work is to the original stream bed elevation no additional dredge or fill of the bed is allowed.
11. All water quality criteria must be maintained during the work and after work has been completed.
12. Work shall not disturb vegetative root systems within the stream channel 20 ft. beyond the culvert inlet or outlet.

## Activity RR-9: Temporary Scaffolding

**Activity Description:** Placement of temporary scaffolding in or adjacent to a watercourse to allow work on a bridge superstructure. Scaffolding will provide pedestrians with a dry elevated work environment to otherwise inaccessible sections of the bridge superstructure. (Note: To spread the load of the temporary scaffolding supports, it's recommended that a 6"x12" wooden board be laid flat on the stream bed. Since the scaffolding frames are typically 5'x6', this would equate to slightly less than 6 sq. ft. of impact per support leg.)

**Recommended BMPs:** 1, 2, 3, 6, 11, 12, 13, 14.

In addition to the General Criteria for Project Activities on pages 18 and 19, the following shall apply:

### Activity-Specific Criteria:

- The work must be a publicly maintained roadway, public property or easement held by the state or a municipality.
- The proposed bridge maintenance does not involve work on any portion of the structure normally located within surface waters.
- Work shall be done with the equipment located outside of surface waters or wetlands.
- The total square feet of impact associated with each support shall not exceed 6 square feet.
- Designated Rivers: An activity will not qualify for the Routine Roadway Notification process if within 250 feet of a Designated River.

Exception 1: If the activity is located on a tier 1 stream whose contributing watershed above the stream crossing is 200 acres or smaller.

Exception 2: If the structure does not convey a direct surface water connection to the Designated River.

**NOTE: If the work is within ¼-mile of any Designated River a copy of the Routine Roadway Notice must be submitted to the River's Local Advisory Committee a minimum of five days prior to the start of work.**

- *This activity does not qualify for the Certified Culvert Maintainer Program.*

### General Conditions:

1. Appropriate siltation/erosion controls shall be in place prior to any excavation, shall be maintained during construction, and remain until the area is stabilized.
2. Work shall be done with the equipment located outside of surface waters or wetlands, and at no time shall equipment be staged in the water. The contractor shall avoid locating equipment on jurisdictional bank, except when no other non-jurisdictional work areas are available to complete the work.
3. Within three days of final grading or temporary suspension of work in an area that is in or adjacent to wetlands or surface waters, all exposed soil areas shall be stabilized by seeding and mulching during the growing season, or if not within the growing season, by mulching with tackifiers. Stabilization shall include mulching with tackifiers on slopes less than 3:1 or netting and pinning on slopes steeper than 3:1.
4. Channel matting and seeding shall be installed within all disturbed soil areas along watercourses prior to receiving flow.
5. Siltation and erosion controls must be removed once the area is stabilized.

### Activity-Specific Conditions:

6. Extreme precautions shall be taken within riparian areas to limit removal of vegetation and areas cleared of vegetation shall be re-vegetated within three days of the completion of the project with like native species.
7. Vegetation removal shall meet the requirements of RSA 483-B, Surface Water Quality Protection Act, if it applies.
8. Only the placement of the scaffolding shall be within the water.
9. The total square feet of impact associated with each support shall not exceed 6 square feet.
10. No dredge shall be done or fill introduced for installation of the scaffolding.
11. Installation and removal of temporary scaffolding shall be done during low flow conditions.
12. Scaffolding installations shall consider the potential for ice floes at the location and shall monitor the weather and remove the scaffolding prior to ice forming on the flowing stream.
13. The contractor shall monitor the weather and shall not commence work when a significant rain event is in the forecast and shall remove all materials from jurisdiction if an extreme precipitation event is forecasted or take appropriate measures to mitigate the potential impact of the event.
14. Structures shall not be in the stream for more than 16 weeks.
15. No wheeled or tracked vehicles shall be supported by this proposed infrastructure.
16. All by products of the work shall be properly collected and disposed of outside of wetland jurisdiction.



# **Best Management Practices**

## ***List of Best Management Practices in Routine Roadway Maintenance Activities Manual***

### **Perimeter Control**

- BMP #1 Silt Fence
- BMP #2 Erosion Control Mix Berm
- BMP #3 Staked Filter Sock/Straw Wattle
- BMP #4 Temporary Storm Drain Inlet Protection

### **In-Stream Turbidity Control**

- BMP #5 Temporary Stone Check Dam
- BMP #6 Temporary Cofferdam (Diversion or Bypass)
- BMP #7 Sediment Filter Bag
- BMP #8 Sediment Retention Basin
- BMP #9 Outlet protection (Stone Rip-Rap)
- BMP #10 Turbidity Curtain

### **Erosion Control**

- BMP #11 Temporary Erosion Control Blanket (Matting)
- BMP #12 Surface Roughening and Slope Tracking
- BMP #13 Temporary or Permanent Mulching
- BMP #14 Temporary and Permanent Seeding

## **BMP #1: Silt Fence**

### **General Description:**

Silt fence is a temporary sediment barrier consisting of fabric attached to supporting posts and entrenched into the soil. This barrier is installed along the edge of land disturbance and/or across or at the toe of a slope, to intercept and retain small amounts of sediment from disturbed or unprotected areas. Silt fence primarily functions to slow and pond the water and allow soil particles to settle.

### **Advantages/Limitations:**

- Silt fence only function where the flow to the silt fence is overland sheet flow. ***Silt fences should not be used across streams, channels, swales, ditches or other drainage ways.*** Silt fences installed across a concentrated flow path are subject to undercutting, end cutting, and overtopping. This can result in the bypass of sediment-laden water from site areas and complete failure of the silt fence.
- Silt fence should only be installed parallel to the contour of the slope and should never be installed perpendicular to the slope.
- The drainage area must be less than ¼-acre per 100 feet of silt fence.

### **Installation/Maintenance:**

- Silt fences should be installed according to the manufacturer's recommendations, with posts spaced no greater than six feet apart.
- Silt fences should be entrenched into the soil a minimum of four inches.
- The ends of silt fences should be flared upslope and backfilled.
- They must be inspected and maintained after each rain event (½-inch in 24 hours) and daily during prolonged rainfall.
- Sediment deposition should be removed, at a minimum, when the silt deposition accumulates to one-half the height of the fence.
- Silt fences should be removed when they have served their useful purpose, but not before the upslope areas have been permanently stabilized (i.e., have achieved 85% vegetative cover).

## BMP #2: Erosion Control Mix Berm

### General Description:

An erosion control mix berm is a trapezoidal berm that intercepts sheet flow and ponds runoff, allowing solids to settle, and filtering sediment as well. This barrier is installed along the edge of land disturbance and/or across or at the toe of a slope, to intercept and retain small amounts of sediment from disturbed or unprotected areas. They are an environmentally sensitive and cost-effective alternative to silt fence.

### Advantages/Limitations:

- Erosion control mix can be manufactured on or off the project site.
- Sediment barriers should not be used in areas of concentrated flows. Under no circumstances should erosion control mix barriers be constructed in live streams or in swales where there is the possibility of a washout.

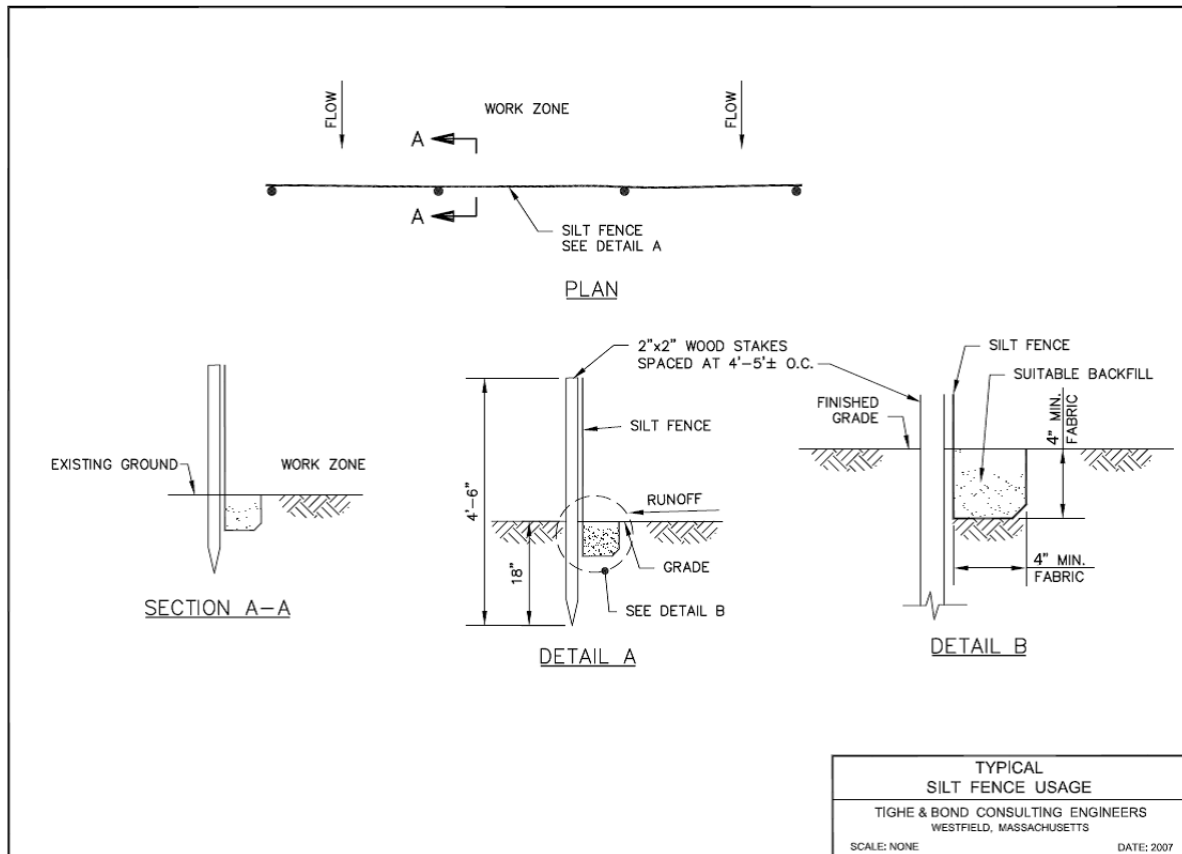

- The erosion control mix is organic, biodegradable, renewable and can be left onsite. This is particularly important below embankments near streams, as re-entry to remove or maintain a synthetic barrier can cause additional disturbance.
- An alternative erosion control mix berm construction may incorporate stone encapsulation (with 2.5-inch minus stone) of a stump grinding/erosion control mix berm in order to provide additional berm stability in larger drainage areas and provide additional filtration for increased sediment loading conditions.

### Installation/Maintenance:

- The berm must consist primarily of organic material, separated at the point of generation, and may include shredded bark, stump grindings, composted bark or acceptable manufactured products. Wood and bark chips, ground construction debris or reprocessed wood products are not acceptable as the organic component of the mix.
- The erosion control mix berm barrier must be a minimum of 12 inches high, as measured on the uphill side of the barrier, and a minimum of two feet wide.
- Erosion control mix should contain a well-graded mixture of particle sizes and may only contain rocks less than four inches in diameter.
- Erosion control mix must be free of refuse, physical contaminants and material toxic to plant growth. The berm should be installed to maintain surface contact and avoid potential creation of voids that would enable fines to wash under the barrier. It may be necessary to cut tall grasses or woody vegetation. Care should be taken to create surface contact when installing erosion control mix berms during frozen conditions.
- This barrier is installed across or at the toe of a slope, to intercept and retain small amounts of sediment from disturbed or unprotected areas.
- Installation of berms with J-Hooks will increase erosion control mix berm efficiency and reduce erosion-causing failures.
- They must be inspected and maintained after each rain event ( $\frac{1}{2}$ -inch in 24 hours) and daily during prolonged rainfall. Sediment deposition should be removed, at a minimum, when the silt deposition accumulates to one-half the height of the berm.

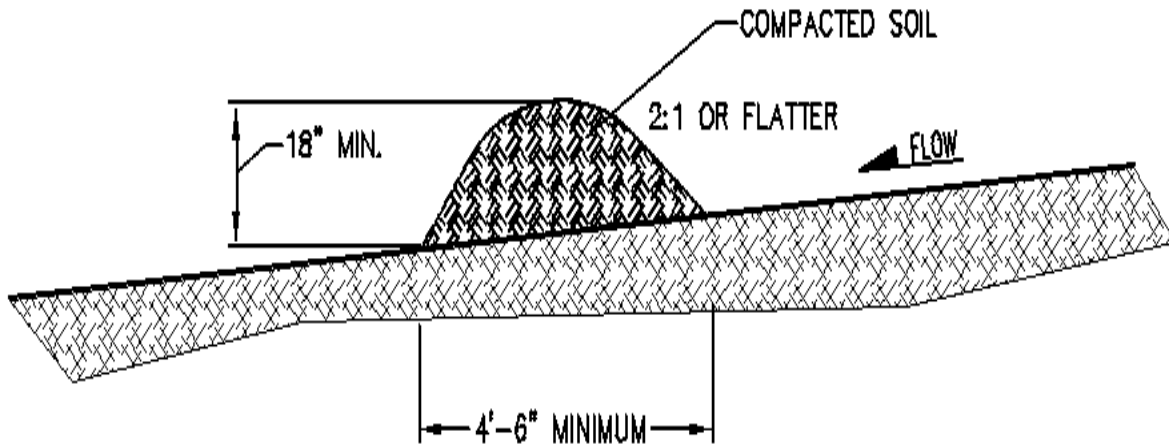

### TEMPORARY BERM

#### NOTES:

1. BERMS SHALL HAVE A HEIGHT OF 18 INCHES, SIDE SLOPES OF 2:1 OR FLATTER AND A MINIMUM BASE WIDTH OF 4.5 FEET.
2. BERMS SHALL BE USED TO INTERCEPT AND DIVERT DRAINAGE TO A DESIGNATED OUTLET.
3. BERMS SHALL NOT BE USED WHERE DRAINAGE AREA EXCEEDS 10 ACRES.

### **BMP #3: Continuous Contained Berm (Staked Filter Sock/Straw Wattle)**

#### **General Description:**

An alternative to a simple erosion control mix berm is a staked filter sock or “Continuous Contained Berm”, consisting of stump grindings or erosion control mix compost encapsulated in stone, or a mesh fabric. A straw wattle consists of straw encapsulated in a mesh fabric.

Staked filter sock or straw wattle barriers are a type of temporary sediment barrier installed across or at the toe of a slope, to intercept and retain small amounts of sediment from disturbed or unprotected areas. They function primarily to slow and pond the water and allow soil particles to settle.

#### **Advantages/Limitations:**

- ***Staked filter sock barriers should generally not be used across streams, channels.*** They are not designed to withstand high heads of water, and therefore should be located where only shallow pools can form. Their use is limited to areas that only contribute sheet flow to the device.
- Staked filter sock barriers constitute a sediment control practice, not an erosion control practice. They must be used in conjunction with other practices that do prevent or control erosion. Improperly applied or installed sediment barriers will increase erosion.
- Staked filter sock and Straw Wattle barriers can be entirely removed as a unit from the site following site stabilization.
- Non-biodegradable mesh encapsulation materials should be removed from the site following 85% vegetative site stabilization.
- Staked filter sock and Straw Wattle barriers may also be used for check dams in applications where installation access or other conditions prevent the use of materials such as stone.

#### **Installation/Maintenance:**

- Continuous contained berms can be manufactured on or off the project site.
- Continuous contained berms should be staked using 2” x 2” wooden stakes placed at 10’ lineal spacing to a depth of 12”.
- The berm should be installed to maintain surface contact and avoid potential creation of voids that would enable fines to wash under the barrier. It may be necessary to cut tall grasses or woody vegetation. Care should be taken to create surface contact when installing Erosion Control mix berms during frozen conditions.
- Staked filter socks must consist primarily of organic material, separated at the point of generation, and may include shredded bark, stump grindings, composted bark, or acceptable manufactured products. Wood and bark chips, ground construction debris or reprocessed wood products will not be acceptable as the organic component of the mix.
- Straw Wattle continuous contained berms should not contain non-native or nuisance species seed sources.
- This barrier is installed across or at the toe of a slope, to intercept and retain small amounts of sediment from disturbed or unprotected areas.
- Installation of berms with J-Hooks will increase erosion control mix berm efficiency and reduce erosion-causing failures.
- They must be inspected and maintained after each rainfall and daily during prolonged rainfall.
- Sediment deposition should be removed, at a minimum, when the silt deposition accumulates to one-half the height of the berm.

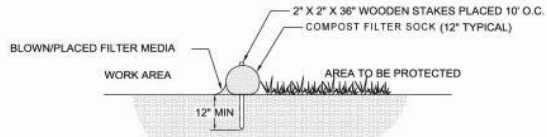

SECTION NTS

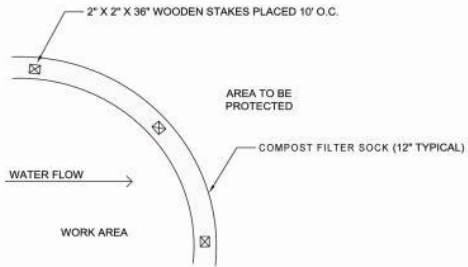

PLAN NTS

**COMPOST FILTER SOCK**  
NTS

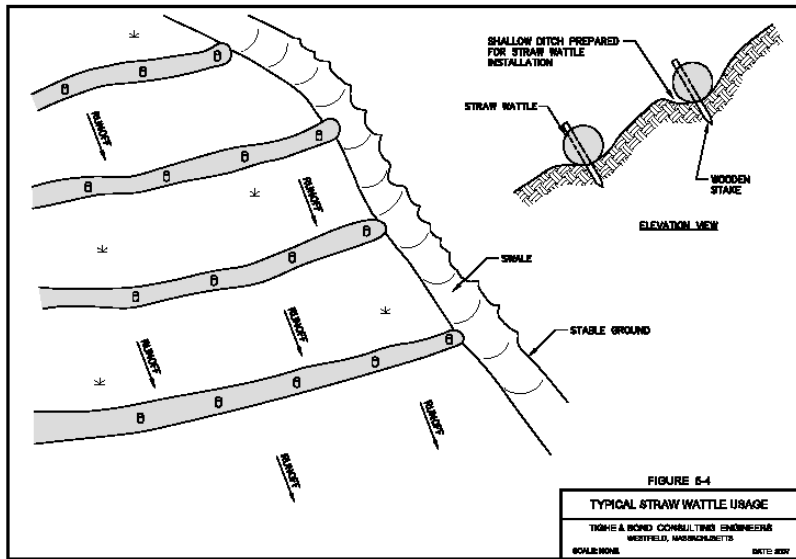

## **BMP #4: Temporary Storm Drain Inlet Protection**

### **General Description:**

A storm drain inlet protection is a sediment barrier installed around a storm drain drop inlet or curb inlet to reduce sediment discharge. The purpose of storm drain inlet protection is to prevent sediment from entering a storm drainage system prior to permanent stabilization of the contributing disturbed area. Sediment removal is accomplished by shallow ponding adjacent to the barrier and resulting settling of the sediment particles. The sediment barrier may be constructed of erosion stone, filter socks, gravel and wire mesh, concrete blocks and gravel or manufactured storm drain inlet protection products are also available (Silt Sack).

### **Advantages/Limitations:**

- This practice is effective in reducing coarse grain suspended particles from runoff. Silt and clay particles will bypass the inlet protection.
- This technique is intended as a secondary sediment area as it will only trap the coarser particles. If turbid water is being directed to this structure and that water does not continue to a sediment trap or basin, alternative solutions for treating the water should be evaluated upslope of the catch basin.
- The inlet protection device should be constructed in a manner that will facilitate Clean-out and disposal of trapped sediments and minimize interference with construction activities.
- In some cases, the storm drain itself may accumulate sufficient sediment to significantly reduce or eliminate its conveyance capacity. To avoid these problems, it is necessary to prevent sediment from entering the system at the inlets.
- This practice includes several types of inlet barriers, the use of which may depend on site conditions and the type of inlet. Other techniques for accomplishing the same purpose may be used, but they should be installed only after careful study of their effectiveness.
- The inlet protection practices are for drainage areas of **less than one acre**. Runoff from large disturbed areas should be routed through a sediment trap or sediment basin.
- Any resultant ponding of stormwater must not cause excessive inconvenience or damage to adjacent areas or structures.

### **Installation/Maintenance:**

- Inlet barriers should be inspected before and after each rain event and repaired as needed.
- Sediment should be removed and the storm drain sediment barrier restored to its original dimensions when the sediment has accumulated to 1/2 the design depth of the barrier.
- If the stone filter becomes clogged with sediment so that it no longer adequately performs its function, the stone must be pulled away from the blocks, cleaned and replaced.
- Removed sediment should be deposited in a suitable area and in such a manner that it will not erode.
- Manufactured sediment barriers should be installed, used, and maintained as specified by the vendor or manufacturer.



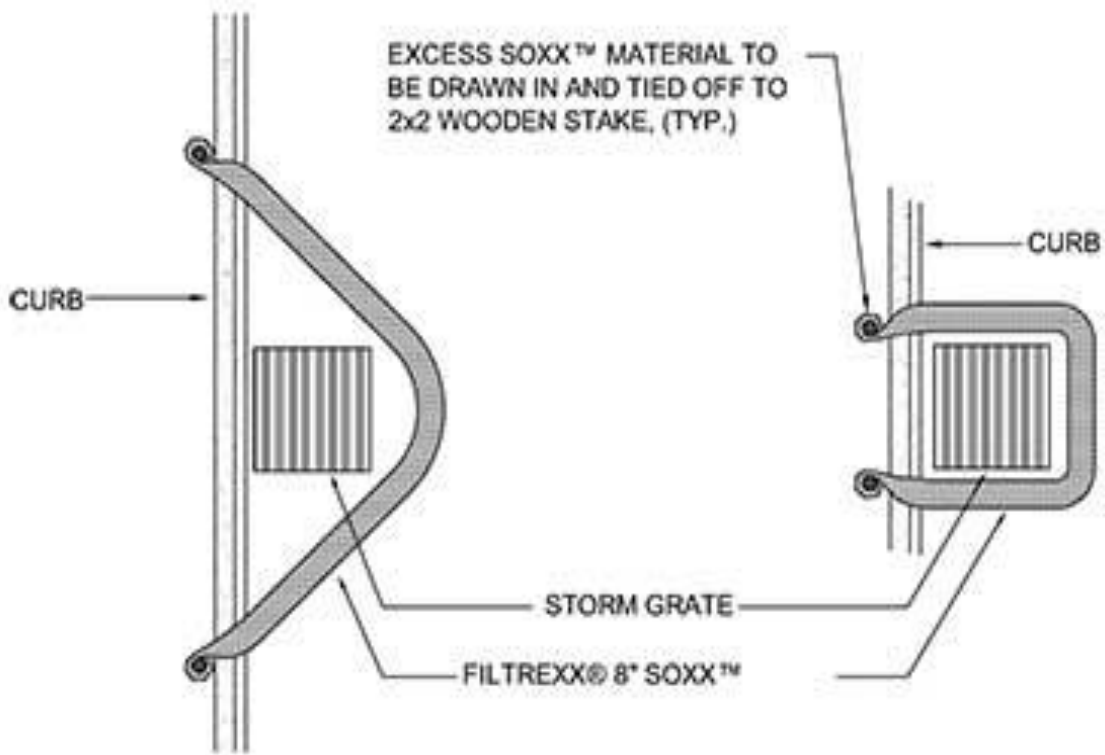

**CURBSIDE OPTION "A" PLAN**

**CURBSIDE OPTION "B" PLAN**

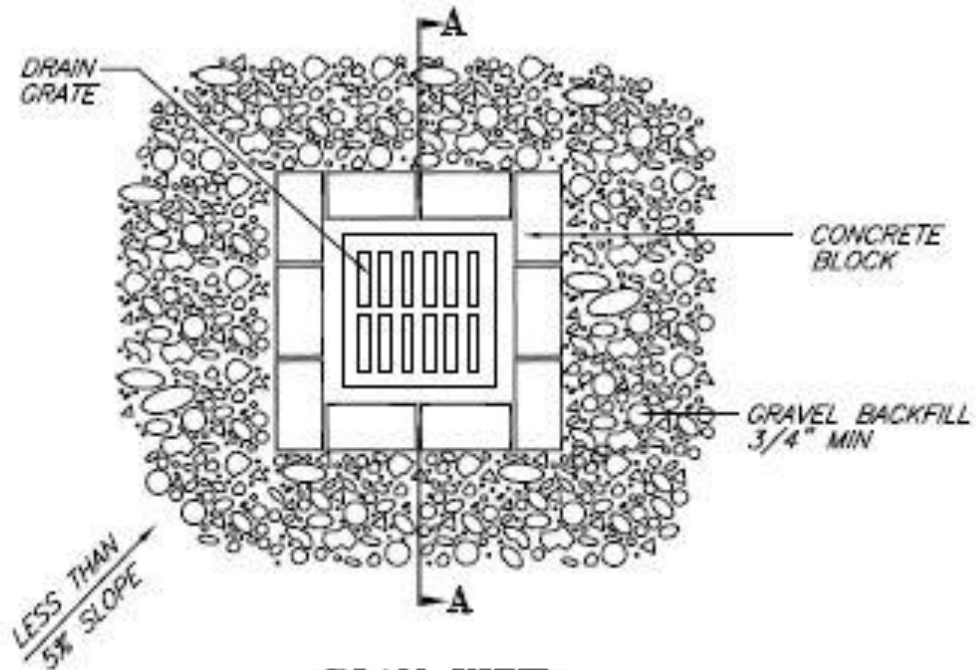

**PLAN VIEW**

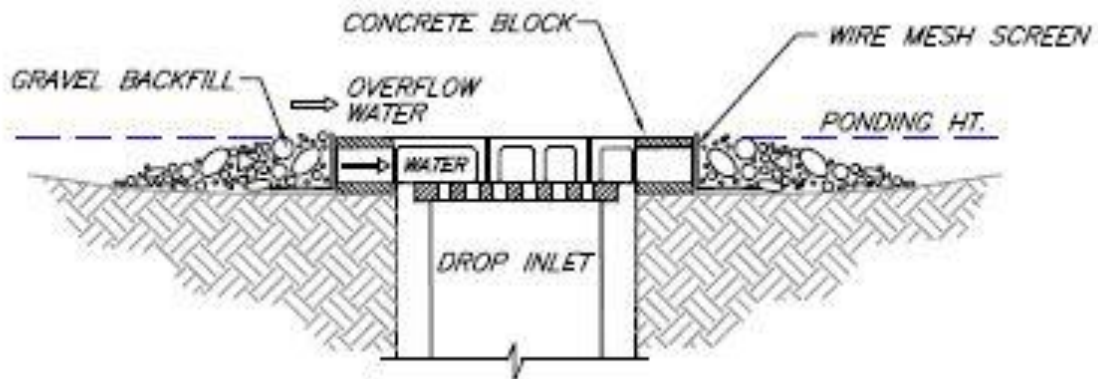

**SECTION A - A**

**NOTES:**

1. DROP INLET SEDIMENT BARRIERS ARE TO BE USED FOR SMALL, NEARLY LEVEL DRAINAGE AREAS. (LESS THAN 5%)
2. EXCAVATE A BASIN OF SUFFICIENT SIZE ADJACENT TO THE DROP INLET.
3. THE TOP OF THE STRUCTURE (PONDING HEIGHT) MUST BE WELL BELOW THE GROUND ELEVATION DOWNSLOPE TO PREVENT RUNOFF FROM BYPASSING THE INLET. A TEMPORARY DIKE MAY BE NECESSARY ON THE DOWNSLOPE SIDE OF THE STRUCTURE.

**CONCRETE BLOCK AND  
GRAVEL DROP INLET  
SEDIMENT BARRIER**

## **BMP #5: Temporary Stone Check Dam**

### **General Description:**

Temporary check dams are small temporary dams typically made of washed 2-inch to 3-inch washed stone. They are constructed across a swale or drainage ditch. They are used to reduce the velocity of concentrated stormwater flows, thereby reducing erosion of the swale or ditch. Check dams may also trap small amounts of sediment generated in the ditch itself. However, the check dam is not a sediment trapping practice and should not be used as such.

### **Advantages/Limitations:**

- Installation of check dams is limited to use in small open channels that drain one acre or less.
- Check dams should **not** be used in either perennially flowing streams or intermittent stream channels.

### **Installation/Maintenance:**

- Stone check dams should be constructed of a well-graded angular 2-inch to 3-inch stone.  $\frac{3}{4}$ -inch stone on the up-gradient face is recommended for better filtering.
- Check dams should be constructed so that the center of the dam is lower than the edges. Erosion caused by high flows around the edges of the dam must be corrected immediately.
- The maximum spacing between the dams should be such that the toe of the upstream dam is at the same elevation as the overflow elevation of the downstream dam.
- The maximum height of the dams should be two feet.
- Check dams should be checked for sediment accumulation after each significant rainfall. Sediment should be removed when it reaches one half of the original height or before.

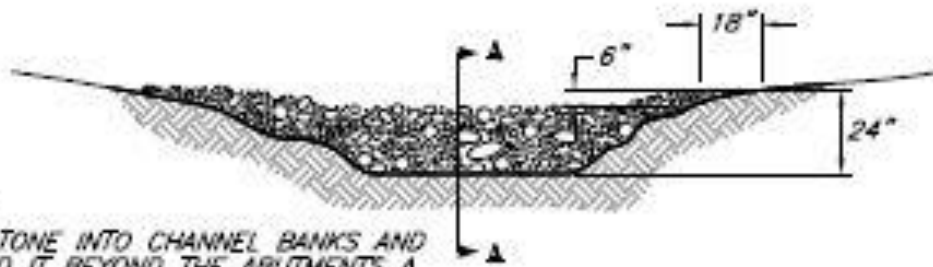

**NOTE:**  
 KEY STONE INTO CHANNEL BANKS AND  
 EXTEND IT BEYOND THE ABUTMENTS A  
 MINIMUM OF 18" TO PREVENT  
 FLOW AROUND THE DAM.

**VIEW LOOKING UPSTREAM**



**SECTION A - A**

*L = THE DISTANCE SUCH THAT POINTS A AND B ARE OF EQUAL ELEVATION*

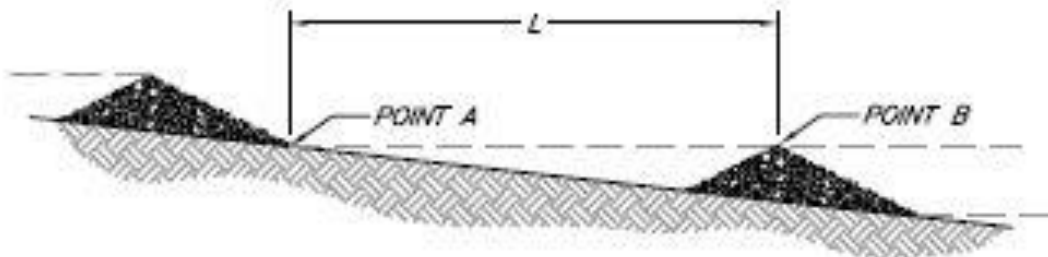

**SPACING BETWEEN CHECK DAMS**

NOT TO SCALE

**STONE  
CHECK DAM**

ADAPTED FROM WAVE EROSION AND SEDIMENT CONTROL BMP MANUAL (2003)

## **BMP #6: Temporary Cofferdam (Temporary Diversion/Clean Water Bypass)**

### **General Description:**

When conditions dictate a dry work area, a temporary sandbag cofferdam can be installed so the work area can be pumped dry to a sediment retention basin and work can begin. In areas subject to rapid water movement, a temporary dam can be constructed with sandbags upstream and downstream of the work area in such a way as to minimize erosion and resulting water turbidity. The dam prevents water from entering the proposed work zone and directs flow into the temporary diversion pipe. The opposite end of the diversion pipe is extended past the downstream cofferdam, thus allowing clean flow to pass through the work zone. The temporary cofferdam can also be constructed to direct flows through a stable temporary bypass.

Sandbags work well as diversion structures, temporary cofferdams, sediment control devices and temporary flow dissipaters during any number of routine roadway maintenance activities. Sandbag cofferdams shall be appropriately designed to ensure work zone safety is not compromised, while maintaining water quality controls. The sandbags shall be stacked no higher than sufficient to direct water into the diversion pipe. When appropriately designed and used as a cofferdam, these sandbags are stable enough for water to pond behind them. The ponded water behind the dam structure can then be pumped to a sediment retention basin or filter bag or diverted through a by-pass to allow work to be performed in-the-dry.

### **Advantages/Limitations:**

- Pipes and pumps shall be appropriately sized in order to avoid potential erosion, scouring, flooding, or property damage. Metrics including channel width, watershed size, and existing erosion condition should be considered for temporary diversion construction. The watershed size and flow estimations contributing to the culvert location can be determined using the USGS StreamStats in New Hampshire [http://streamstatsags.cr.usgs.gov/v3\\_beta/viewer.htm?stabbr=NH](http://streamstatsags.cr.usgs.gov/v3_beta/viewer.htm?stabbr=NH).
- Work within the stream, inclusive of work associated with installation of a cofferdam should be limited to periods of low flow. High flows can be caused by seasonal runoff or precipitation. Local forecasts and weather conditions should be reviewed prior to construction.
- Sandbags should not be overfilled for cofferdam construction.
- If care is not taken to select the point of discharge and provide adequate treatment, the pumped water may discharge to down gradient natural resources such as lakes, wetlands, or streams, with subsequent sedimentation of those waterbodies.
- The temporary cofferdam should be designed to be removed during periods of high flow and periods of non-instream construction.

### **Installation/Maintenance:**

- Locate sandbag cofferdam far enough upslope to isolate the work area and at the downstream limit of work to prevent backflow to the work area.
- Sandbags can be single or double layer.
- Place sandbags such that no gaps are evident.
- The gradient along the flow path must have a positive grade to assure drainage, but should not be so steep as to result in erosion due to high velocity channel flow.
- A pump-around system can be installed as a clean water bypass around the construction area if pumps have been appropriately sized. Pumps should outlet to a stabilized area and not cause scouring or erosion.
- Construction should be monitored to assure that no water quality violations occur.

- The temporary cofferdam structure shall be completely removed upon the completion of work.
- A temporary bypass channel can be also constructed using a sandbag diversion over four-mil. plastic sheeting.
- The confined work area can then be dewatered to a sediment retention basin or sediment filter bag (BMP #7 or #8).

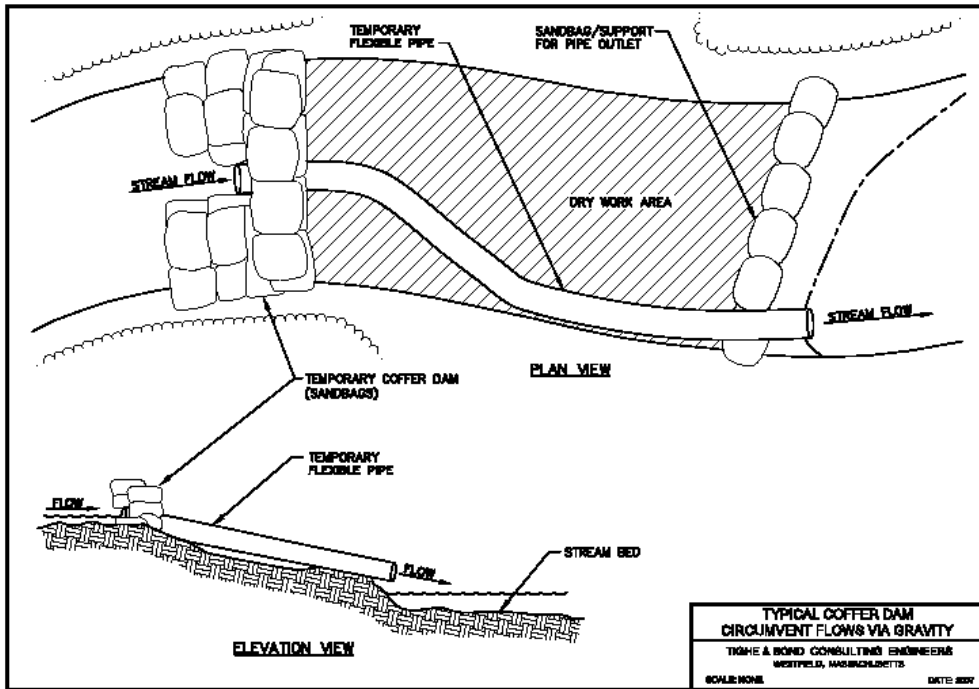
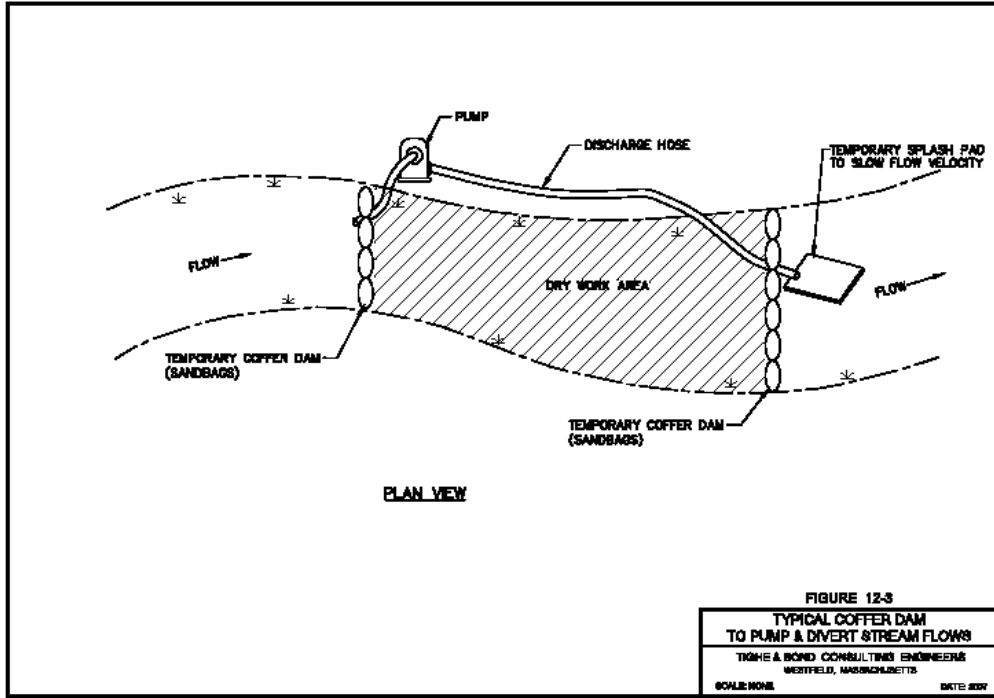

## **BMP #7: Sediment Filter Bag**

### **General Description:**

Sediment filter bags can be used as an effective filter medium to contain sand, silt and sediment when dewatering a proposed work area. Sediment filter bags are placed at the discharge end of a dewatering hose in situations where there is not sufficient available space to construct a sediment retention basin or may be used in conjunction with a sediment retention basin when discharge is particularly turbid. The visual quality of the effluent should be monitored to assess whether additional treatment can be provide to prevent sedimentation of downstream receiving waters.

### **Advantages/Limitations:**

- Sediment filter bags should not be placed within 20 feet of a wetland or surface water.
- To avoid rupture, the bags will be attended and pumping rates monitored as specified by the manufacturer.
- Limit one discharge hose per sediment filter bag.
- Never discharge to areas that are bare or newly vegetated.
- The discharge should be stopped immediately if the receiving area shows any sign of turbidity, instability, or erosion.
- Limitation – Warning that once these bags are filled with sediment they can be extremely heavy and often require machinery to move.

### **Installation/Maintenance:**

- Choose the best location for the dewatering discharge in order to prevent the discharged water from eroding soil on the site.
- Set filter bag on filter fabric and/or a vegetated area.
- A 100-foot vegetated setback is preferred for turbid discharge from the sediment basin outlet. At a minimum, the basin shall have 20 feet of an undisturbed vegetative buffer between it and a surface water, wetland or bank. When practicable and when adequate space allows, double up on BMPs when located within 50 feet of a wetland or water resource.
- Surface water, wetland or bank. When practicable and when adequate space allows, double up on BMPs when located within 50 feet of a wetland or water resource.
- Once the bag is inflated to a height of four feet, pumping shall stop to avoid rupture.
- Prior to removing the bag from the hose, the bag will be tied off below the end of the hose, allowing the bag to drain.
- Filter bags used during construction shall be bundled and removed for proper disposal.



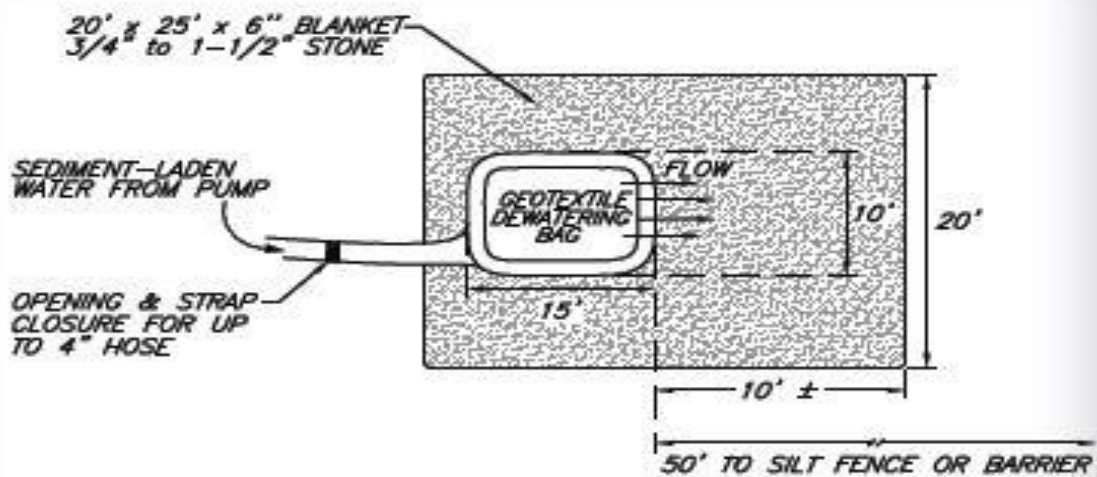

### PLANVIEW

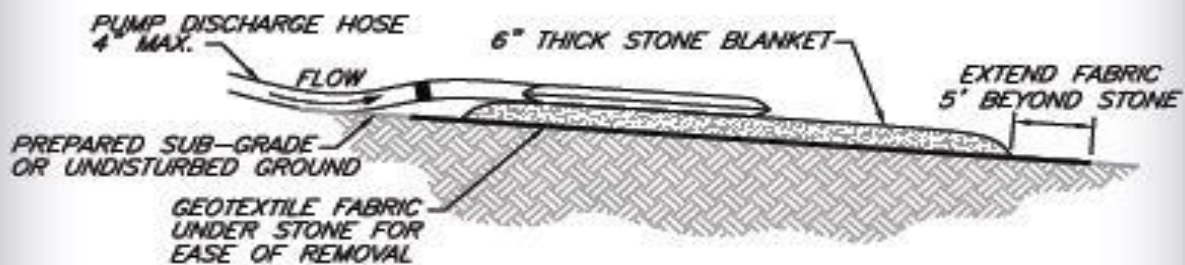

### PROFILE

#### NOTES:

1. GEOTEXTILE BAG MATERIAL BASED ON PARTICLE SIZE IN PUMPED WATER, I.E., FOR COARSE PARTICLES A WOVEN MATERIAL; FOR SILTS/CLAYS A NON-WOVEN MATERIAL.
2. DO NOT OVER PRESSURIZE BAG OR USE BEYOND CAPACITY.
3. LOCATE DISCHARGE SITE ON FLAT UPLAND AREAS AS FAR AWAY AS POSSIBLE FROM STREAMS, WETLANDS, OTHER RESOURCES AND POINTS OF CONCENTRATED FLOW.
4. DOWNGRADIENT FROM RECEIVING AREA MUST BE WELL VEGETATED OR OTHERWISE STABLE FROM EROSION, E.G., FOREST FLOOR OR COARSE GRAVEL/STONE.
5. DISCHARGE LOCATION SHALL MEET ALL REGULATORY SETBACKS FROM WETLANDS AND OTHER WATER COURSES.

**GEOTEXTILE  
DEWATERING  
BAG**

ADAPTED FROM MAINE EROSION AND SEDIMENT CONTROL BMP MANUAL 2003

## **BMP #8: Sediment Retention Basin**

### **General Description:**

A sediment basin is a water impoundment constructed to capture and store sediment and/or debris. Sediment is removed by temporarily storing sediment-laden runoff, allowing time for the sediment particles to settle. A sediment retention basin is a temporary confined area, typically constructed of a combination of non-woven filter fabric over staked hay bales or an erosion control mix berm and used to trap sediment. When a work area is dewatered, water is pumped to a basin located in an undisturbed upland.

### **Advantages/Limitations:**

- The basin traps suspended sediments, allowing clean water to flow through the filter medium, over vegetated ground and back into the subject water body.
- The discharge location of the sediment filter bag requires a stable/vegetated substrate located away from a wetland or water body.
- Sediment filter bags should not be placed within 20 feet of a wetland or surface water.

### **Installation/Maintenance:**

- A 100-foot vegetated setback is preferred for turbid discharge from the sediment basin outlet. At a minimum, the basin shall have 20 feet of an undisturbed vegetative buffer between it and a surface water, wetland or bank. When practicable and when adequate space allows, double up on BMPs when located within 50 feet of a wetland or water resource.
- The sediment basin should be appropriately sized in order to provide adequate time for sedimentation of turbidity prior to discharge from the basin. Basin sizing considerations should include factors such as pumping rate, volume, soil type and turbidity amount.
- The sediment basin should be attended to ensure pumping rates are monitored to avoid discharge of turbid water from the sediment retention basin.

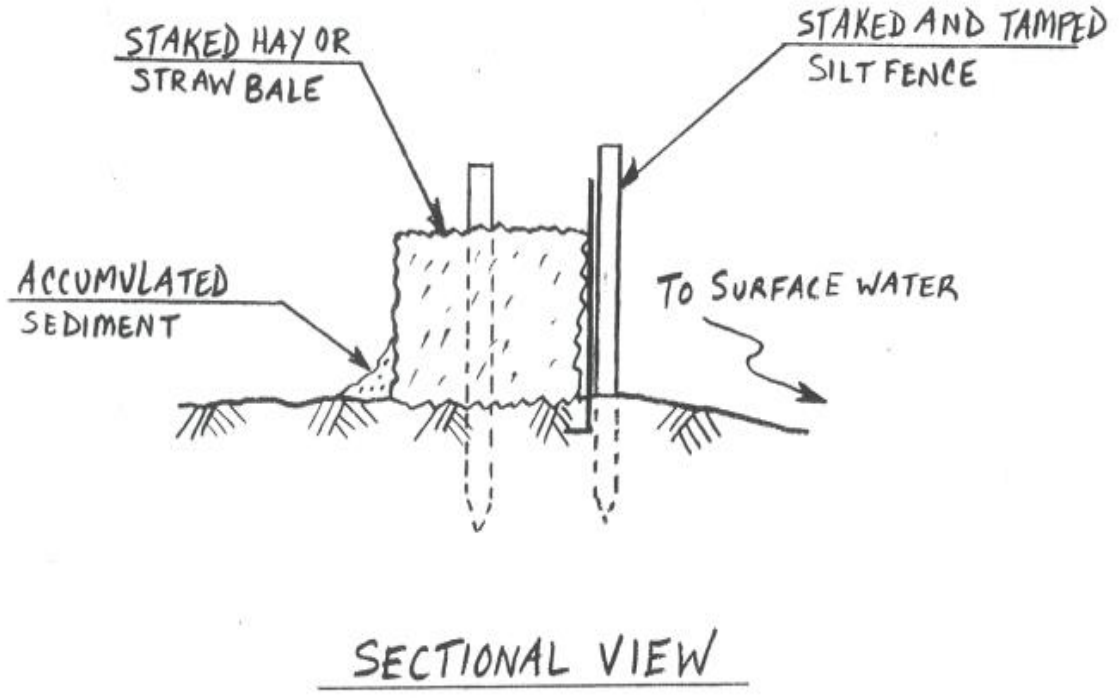
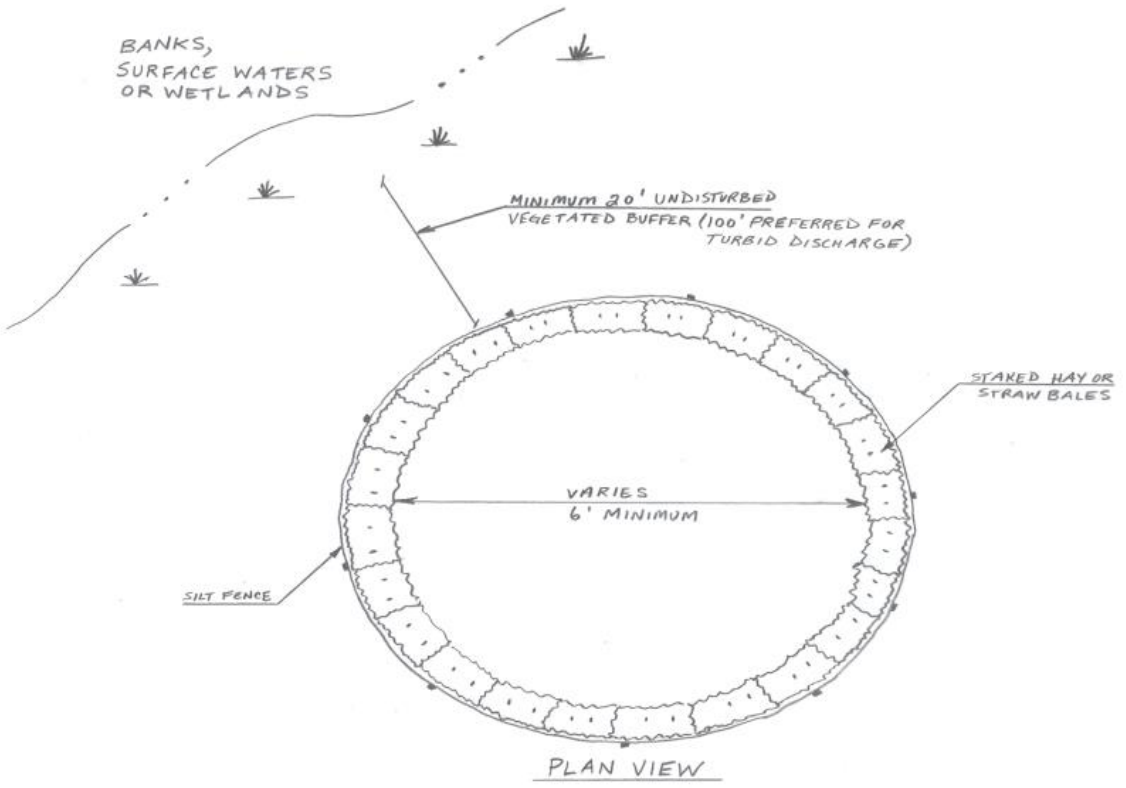

## BMP #9: Outlet Protection

### General Description:

The outlets of pipes and structurally lined channels are points of critical erosion potential. Storm water, which is transported through man-made conveyance systems at design capacity, generally reaches a velocity that exceeds the capacity of the receiving channel or area to resist erosion. Outlet protection is typically provided at stormwater discharge conduits to reduce the velocity of concentrated stormwater flows to prevent scour and minimize the potential for downstream erosion.

### Advantages/Limitations:

- Rip-Rap can be installed at the drainage outlet to absorb the initial impact of the flow and reduce the flow velocity to a level which will not erode the receiving channel or area.
- For culvert outlets, rip-rap provides adequate armor for the immediate area around the outlet subject to erosion.
- All other necessary and appropriate BMPs shall be employed to ensure that no increases in sedimentation, erosion and/or turbidity result.

### Installation/Maintenance:

- The amount of riprap to be used shall be the minimum possible to achieve adequate dissipation of erosive potential as appropriately designed by the activity sponsor.
- The gradation of stone to be used shall be determined by the activity sponsor based on field conditions so that no loss of stone occurs as a result of water flow through the culvert.

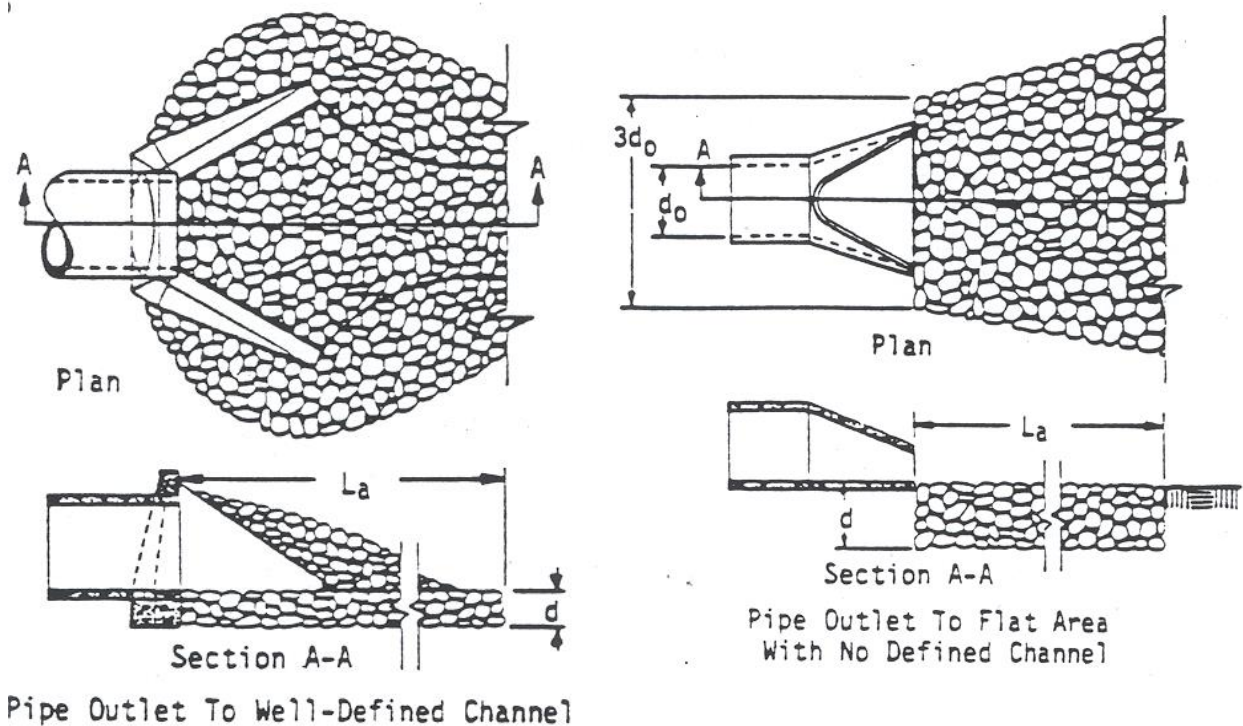

## BMP #10: Turbidity Curtain

### General Description:

Turbidity curtains prove to work effectively at retaining suspended sediment within the water column. The barrier consists of a wire-mesh supported silt fence attached to a floating boom. The boom remains afloat, on top of the water, while the filtration mechanism, anchored to the bed, retains suspended sediments in the work area.

### Advantages/Limitations:

- This method is not for use across flowing streams as the velocity of water may prove to be too substantial for turbidity curtain installation or functionality.
- Turbidity curtains can be effective in quiet water when used to partition and contain sediment to the work area.
- This BMP can, and at times should be, used in conjunction with other BMPs depending upon proposed work. Temporary cofferdams and/or check dams can be used as a first line of defense with turbidity curtain downstream as a second defense.
- Turbidity curtains are most effective when installed parallel to the bank to contain the work area.
- They do not function in shallow or flowing streams.

### Installation/Maintenance:

- The turbidity curtain should not be installed in flowing water.
- The turbidity curtain should be installed as close as possible to the construction area and within the limit of work.
- Turbidity curtains should be installed to avoid bypass of turbid water around or under the curtain.
- Turbidity Curtains must be securely fastened to the bank.
- The Turbidity Curtain should be anchored to the stream bed.
- Work within the stream, inclusive of work associated with installation of a turbidity curtain should be limited to periods of low flow. High flows can be caused by seasonal runoff or precipitation. Local forecasts and weather conditions should be reviewed prior to construction.
- The turbidity curtain should be designed to be removed during periods of high flow and periods of non-instream construction.

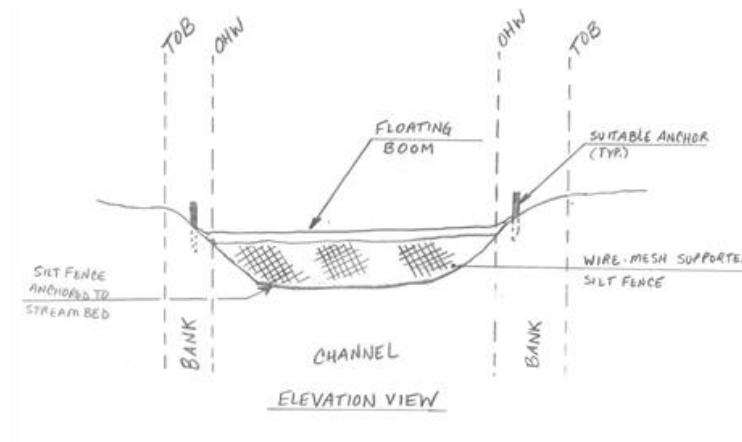

## **BMP #11: Erosion Control Blanket/Matting**

### **General Description:**

Erosion control blankets or mats consist of protective manufactured mulch blankets, installed on prepared soil surfaces to provide erosion protection and surface stability on steep slopes, vegetated channels, or shorelines during vegetation establishment.

Erosion control blankets temporarily stabilize and protect disturbed soil from raindrop impact and surface erosion. Like other types of mulch, the blankets help increase infiltration, decrease compaction and soil crusting and conserve soil moisture.

### **Advantages/Limitations:**

- Erosion control blankets can be applied to steep slopes, vegetated waterways and other areas sensitive to erosion to supplement vegetation during initial establishment and help provide for safe conveyance of runoff over the protected surface.
- Erosion control blankets increase the germination rates for grasses and legumes, and promote vegetation establishment.
- Erosion control blankets also protect seeds from predators and reduce desiccation and evaporation by insulating the soil and seed environment.
- All erosion control blankets shall be made with wildlife-friendly biodegradable netting.

### **Installation/Maintenance:**

- The most critical aspect of installing mats is obtaining firm continuous contact between the mat and the soil. Without such contact, the mat is useless and erosion occurs.
- Matting and staples should be installed in accordance with the manufacturer's recommendations.
- Blankets should be installed vertically downslope.
- Matting should be installed to overlap so that runoff flows over the adjacent blanket instead of under.

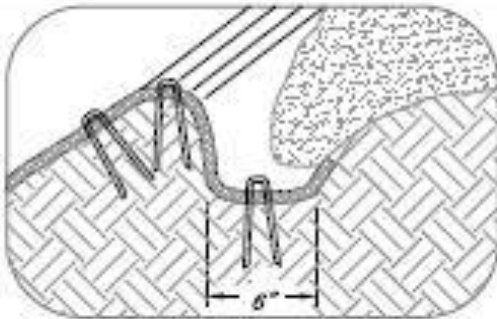

**LONGITUDINAL ANCHOR TRENCH**

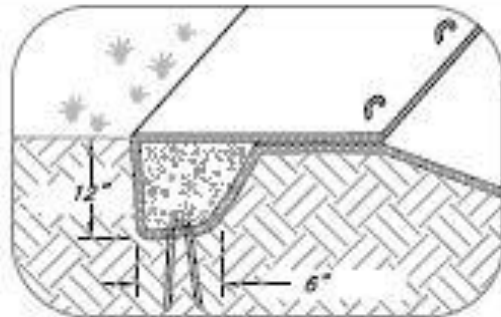

**TERMINAL SLOPE AND CHANNEL ANCHOR TRENCH**

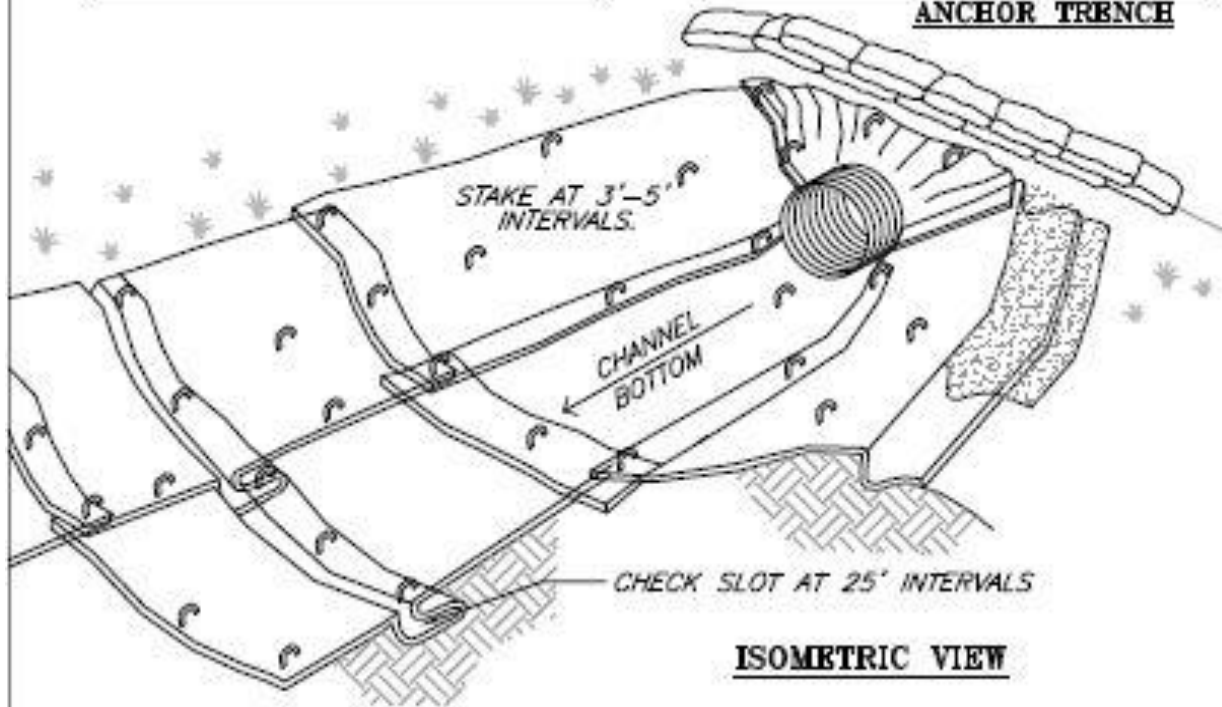

**ISOMETRIC VIEW**

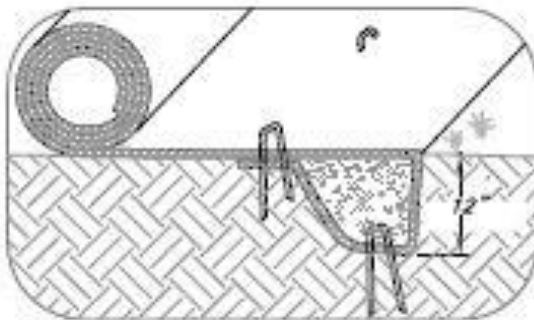

**INITIAL CHANNEL ANCHOR TRENCH**

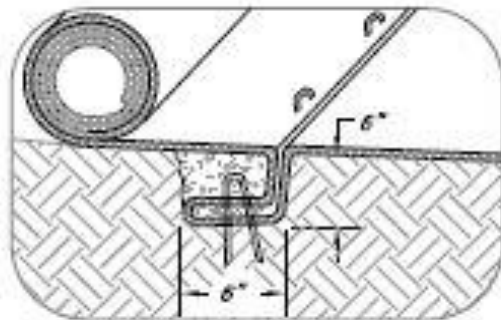

**INTERMITTENT CHECK SLOT**

**NOTES:**

1. DIMENSIONS GIVEN IN THE DRAWINGS ARE EXAMPLES; DEVICE SHOULD BE INSTALLED PER MANUFACTURER'S SPECIFICATIONS.
2. CHECK SLOTS TO BE CONSTRUCTED PER MANUFACTURER'S SPECIFICATIONS.
3. STAKING OR STAPLING LAYOUT PER MANUFACTURER'S SPECIFICATIONS.

ADAPTED FROM J. McCULLAH 1994

**EROSION BLANKETS  
CHANNEL INSTALLATION**

BLANKETS SHOULD  
BE INSTALLED VERTICALLY  
DOWNSLOPE.

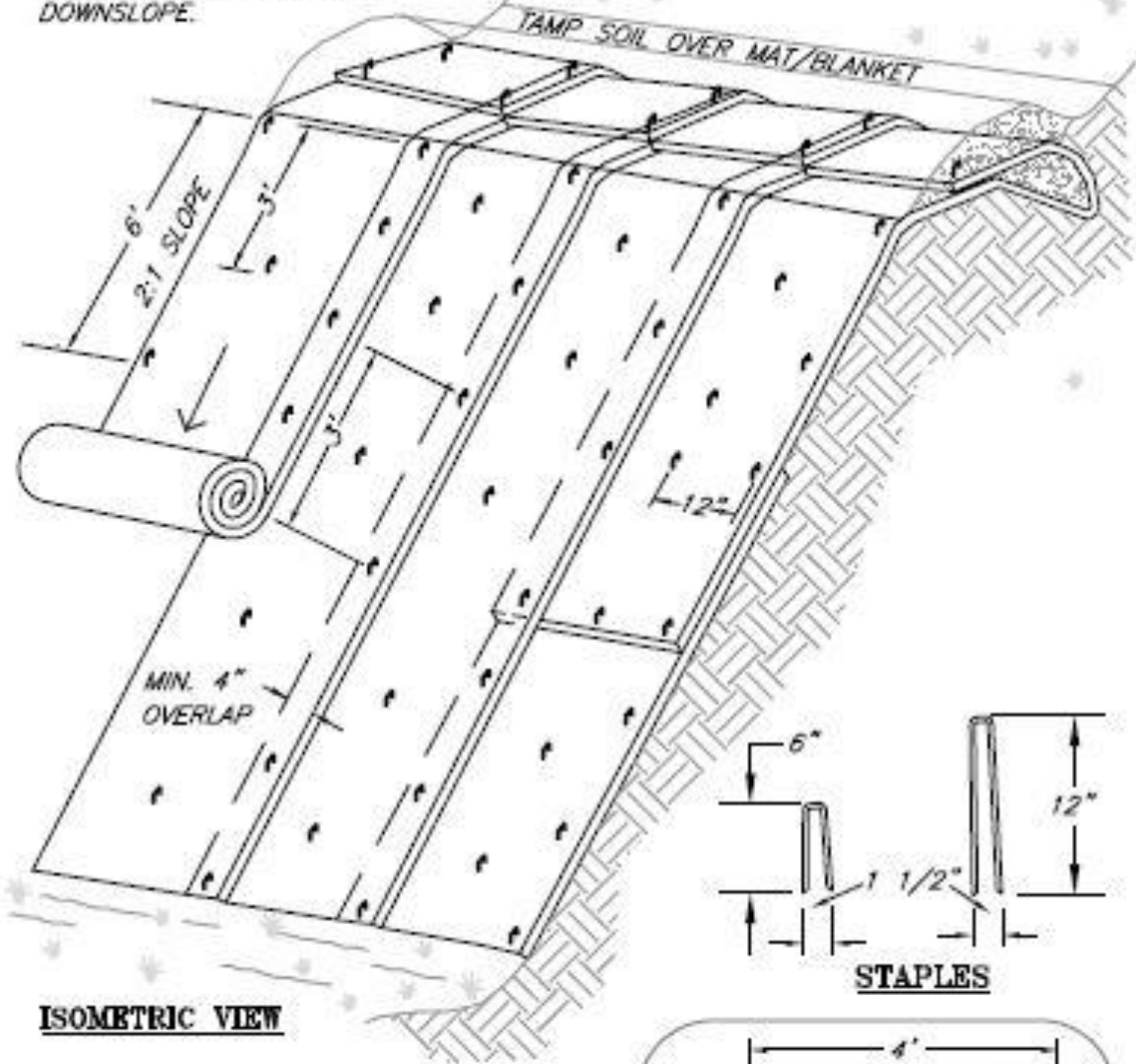

**ISOMETRIC VIEW**

**TYPICAL SLOPE  
SOIL STABILIZATION**

**NOTES:**

1. DIMENSIONS GIVEN IN THE DRAWINGS ARE EXAMPLES; DEVICE SHOULD BE INSTALLED PER MANUFACTURER'S SPECIFICATIONS.
2. SLOPE SURFACE SHALL BE FREE OF ROCKS, CLODS, STICKS AND GRASS. MATS/BLANKETS SHALL HAVE GOOD SOIL CONTACT.
3. APPLY PERMANENT SEEDING BEFORE PLACING BLANKETS.
4. LAY BLANKETS LOOSELY AND STAKE OR STAPLE TO MAINTAIN DIRECT CONTACT WITH THE SOIL. DO NOT STRETCH.

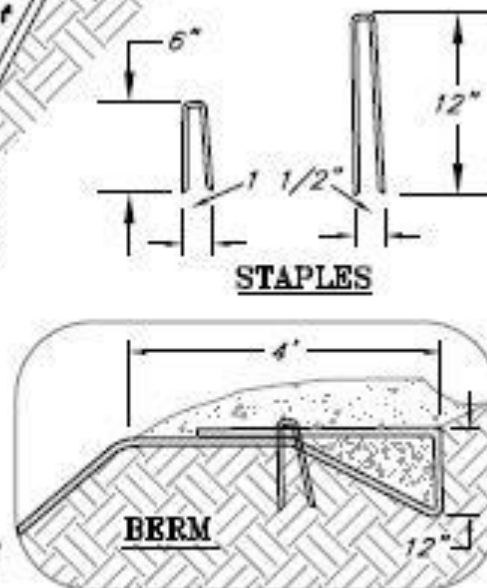

**NOT TO SCALE**

**EROSION BLANKETS  
SLOPE INSTALLATION**

ADAPTED FROM J. McCULLAH 1984



## **BMP #12: Surface Roughening and Slope Tracking**

### **General Description:**

**Surface roughening** and **slope tracking** are techniques for creating furrows in a bare soil surface by hand-raking or tracking the slope with construction equipment. The purpose of surface roughening is to aid the establishment of vegetative cover from seed, to reduce runoff velocity and increase infiltration, and to reduce erosion and provide for sediment trapping. Slope tracking uses machinery to groove the slope to create a series of ridges and depressions that run across the slope, on the contour.

### **Advantages/Limitations:**

- **Surface roughening and slope tracking** applies to all construction slopes to facilitate long-term stabilization with vegetation, and particularly slopes steeper than 3:1.
- A rough, loose soil surface gives a mulching effect that provides more favorable moisture conditions than hard, smooth surfaces; this aids seed germination. Graded areas with smooth, hard surfaces may be initially attractive, but such surfaces increase the potential for erosion.

### **Installation/Maintenance:**

- Slope Tracking uses machinery to create a series of ridges and depressions that run across the slope, on the contour.
- Limit roughening with tracked machinery to soils with a sandy textural component to avoid undue compaction of the soil surface.
- Operate tracked machinery up and down the slope to leave horizontal depressions in the soil.
- Do not back-blade during the final grading operation.
- Immediately seed and mulch roughened areas to obtain optimum seed germination and growth.



**TRACKING**

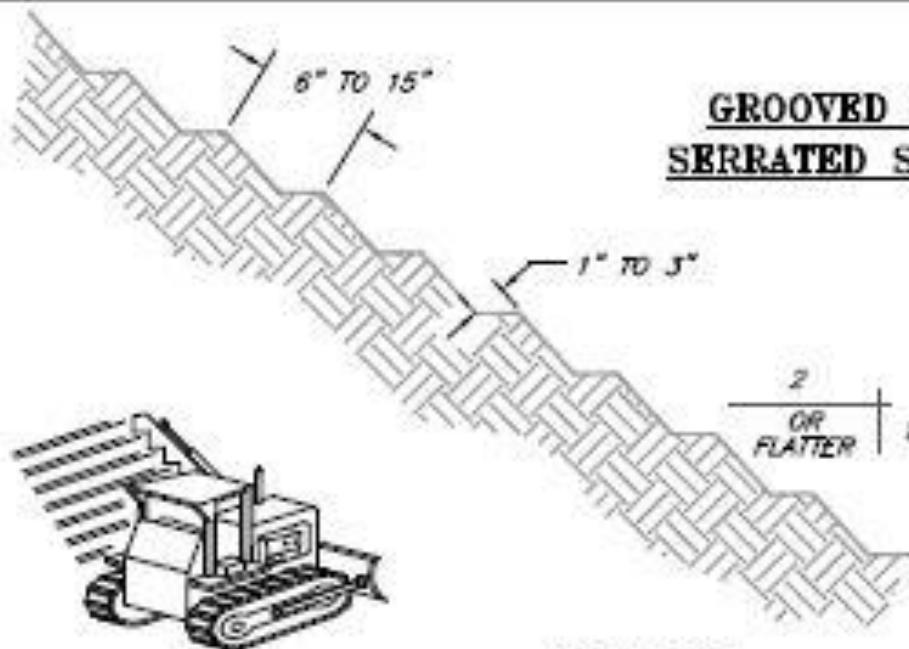

**GROOVED OR SERRATED SLOPE**

**NOT TO SCALE**

**NOTE:**

GROOVE BY CUTTING SERRATIONS ALONG THE CONTOUR. IRREGULARITIES IN THE SOIL SURFACE CATCH RAINWATER, SEED, MULCH AND FERTILIZER.

**SURFACE ROUGHENING**

ADAPTED FROM J. WOLLAH 1994

## **BMP #13: Temporary and Permanent Mulching (Hay, Straw, Wood Chip, Bark)**

### **General Description:**

Mulch should be applied on highly erodible soils, on critically eroding areas and on areas where conservation of moisture will facilitate plant establishment. Mulching conserves moisture, reduces runoff and erosion, controls weeds, helps establish plant cover, and improves water quality.

**Permanent mulch** consists of the application of long-term surface cover such as **bark, wood chips**, or erosion control mix. Permanent mulch can be used as a permanent ground cover, as an overwinter stabilization mulch, or left to naturalize. It is not designed to support grass vegetation, but legumes or woody vegetation may be established for additional stability.

**Temporary mulching** consists of the application of plant residues or other suitable materials to the soil surface such as **hay** or **straw**. If less than 90% of the soil surface is covered by mulch, additional mulch should be immediately applied.

The choice of materials for mulching should be based on site conditions, soils, slope, flow conditions, and time of year.

### **Advantages/Limitations:**

- Mulching aids in the growth of vegetation by conserving available moisture, controlling weeds and providing protection against extreme heat and cold.
- Areas that cannot be seeded within the growing season should be mulched for over-winter protection.
- Mulching reduces erosion potential by protecting the exposed soil surface from direct impact by rainfall.
- Mulches can also protect the infiltration rate of the soil, prevent soil compaction, and provide a suitable microclimate for seed germination.
- Mulch should not be used within areas of concentrated flows.
- This is the quickest and most cost effective method of preventing erosion on disturbed soils and its value should not be underestimated.

### **Installation/Maintenance:**

- The area should be seeded at the beginning of the next growing season.
- All temporary mulches must be inspected periodically and in particular after rainstorms, to check for rill erosion or displacement of the mulch.
- Areas that have been temporarily or permanently seeded should be mulched immediately following seeding.
- Mulching should be completed within the following specified time periods from original soil exposure:
  - Within 100 feet of rivers and streams, wetlands, and in lake and pond watersheds, the time period should be no greater than seven days. This three-day limit should be reduced further during wet weather periods.
- The goal should be to stabilize the site at the end of each day.

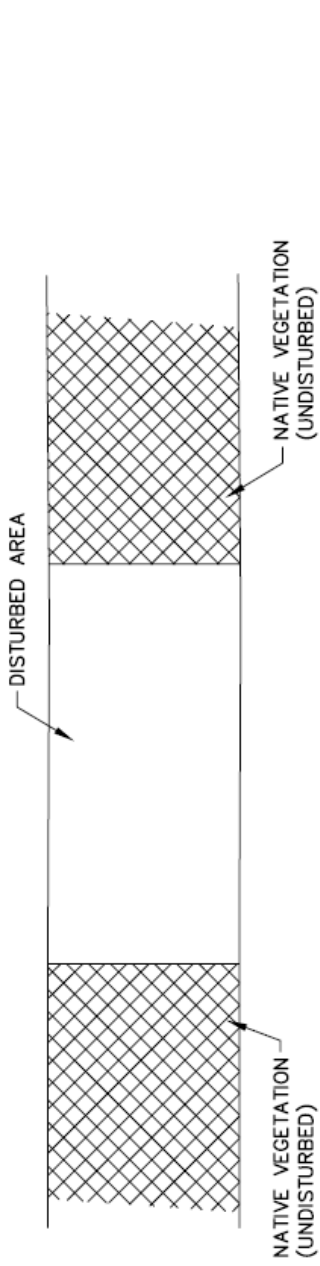

PLAN VIEW

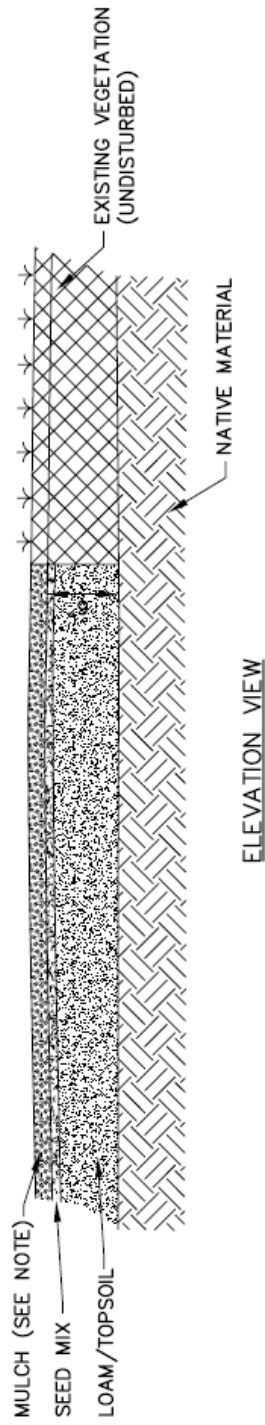

ELEVATION VIEW

NOTES:

1. MULCH MAY CONSIST OF HAY, STRAW OR WOODCHIPS.
2. THICKNESS OF MULCH APPLICATION DEPENDS ON MATERIAL USED.

**TYPICAL MULCH APPLICATION**

TIGHE & BOND CONSULTING ENGINEERS  
WESTFIELD, MASSACHUSETTS

SCALE: NONE DATE: 2007

## **BMP #14: Permanent Vegetation (Seeding)**

### **General Description:**

Runoff and sheet erosion caused by splash erosion (raindrop impact on bare soil) is the source of most fine particles in sediment. **Permanent vegetation** cover should be established on disturbed areas where permanent, long-lived vegetative cover is needed to stabilize the soil, to reduce damages from sediment and runoff, and to enhance the environment. The most effective and economical means of controlling sheet and rill erosion is to establish a permanent vegetative cover. Proper seedbed preparation and the use of quality seed are important in this practice.

### **Advantages/Limitations:**

- Seeding an area and establishment of vegetation will stabilize soil, reduce damage from sediment, maintain or improve water quality and reduce stormwater runoff.
- Runoff should be diverted from the area prior to seeding.

### **Installation/Maintenance:**

- Where the soil has been compacted by construction operations, loosen soil to a depth of four inches before applying fertilizer, lime and seed.
- If applicable, fertilizer and organic soil amendments should be applied during the growing season.
- Temporary seeding should typically occur prior to September 15. Areas seeded between May 15 and August 15 should be covered with straw mulch. At a minimum, 85% of the soil surface should be covered by vegetation prior to October 15. If this condition is not achieved, implement other temporary stabilization measures for overwinter protection, and complete permanent seed stabilization during the next growing season.
- Based on inspection, areas should be reseeded to achieve full stabilization of exposed soils.
- Apply limestone and fertilizer according to soil test recommendations. No fertilizer shall be applied to vegetation or soils located within 25 feet of the shoreland reference line of any public water. Beyond 25 feet, slow or controlled release fertilizer, as defined by DES, may be used.
- Apply seed uniformly as specified.
- Depending upon site conditions, seeding mixtures shall conform to Section 644.2.2 or 644.2.3 of the 2016 version of the publication by NHDOT entitled, *Standard Specifications for Road and Bridge Construction*.

### **Hydroseeding:**

When hydroseeding (hydraulic application), prepare the seedbed as specified above or by hand raking to loosen and smooth the soil and to remove surface stones larger than two inches in diameter. Slopes must be no steeper than 2:1 (two foot horizontally to one foot vertically). Lime and fertilizer may be applied simultaneously with the seed. The use of fiber mulch on critical areas is not recommended (unless it is used to hold straw or hay). Better protection is gained by using straw mulch and holding it with adhesive materials or 500 pounds per acre of wood fiber mulch. **Seeding rates must be increased 10% when hydroseeding.**

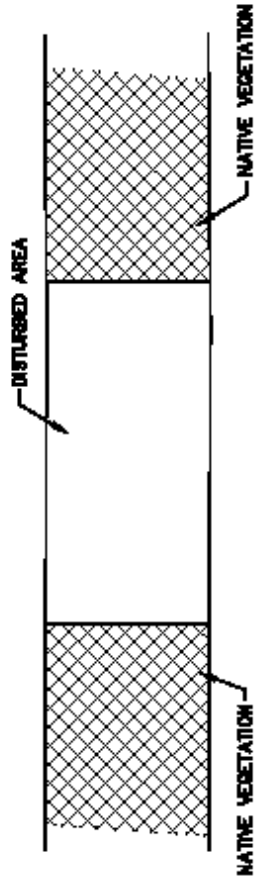

PLAN VIEW

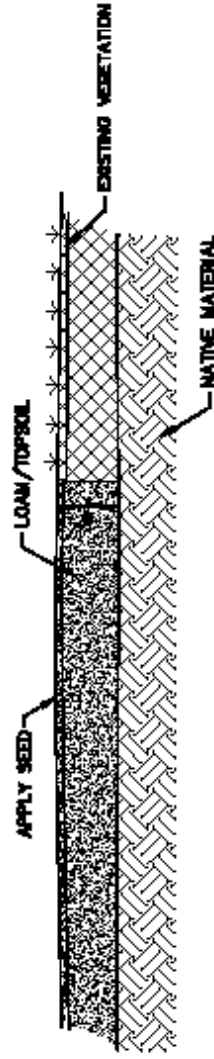

ELEVATION VIEW

**NOTE:**

1. SEED MIX APPLICATION IN ACCORDANCE WITH MANUFACTURER'S RECOMMENDATIONS.

FIGURE 16-1

**LOADING AND SEEDING**

TRINHA & BOND CONSULTING ENGINEERS  
WESTFIELD, MASSACHUSETTS

SCALE: NONE DATE: 8/9/07

80388/EROSION CONTROL/FIG15-1

<b>Seeding Recommendations for Temporary Vegetation</b>		
<b>Species</b>	<b>Pounds (lbs.) Per Acre</b>	<b>Remarks</b>
Winter Rye	2 BU. Or 112 lbs.	Best for fall seeding. Seed from August 15 to September 15 for best cover. Seed to a depth of 1 inch.
Oats	2.5 BU. or 80 lbs.	Best for spring seeding. Seed no later than May 15 for summer protection. Seed to a depth of 1 inch.
Annual Ryegrass	40 lbs.	Grows quickly, but is of short duration. Use where appearances are important. Seed early spring and/or between August 15 and September 15. Cover the seed with no more than 0.25 inch of soil
Perennial Ryegrass	30 lbs.	Good cover which is longer lasting than annual ryegrass. Seed between April 1 and June 1 and/or between August 15 and September 15. Mulching will allow seeding throughout the growing season. Seed to a depth of approximately 0.5 inch.
Source: Minnick, E.L. and H.T. Marshall. (August 1992)		

<b>Seeding Recommendations for Permanent Vegetation</b>			
<b>Seed Mix Type</b>	<b>Species</b>	<b>Pounds (lbs.) Per Acre</b>	<b>Remarks</b>
Park Seed Type 15	Creeping Fescue	40	Park seed Type 15 shall normally be used on loam areas.
	Perennial Ryegrass	50	
	Kentucky Bluegrass	25	
	Redtop	5	
		Total= 120	
Slope Seed Type 44	Creeping Red Fescue	35	Slope seed Type 44 shall normally be used for all slope work unless amended by the Engineer to suit special local conditions encountered.
	Perennial Ryegrass	30	
	Redtop	5	
	Alsike Clover	5	
	Birdsfoot Trefoil	5	
		TOTAL= 80	

# Appendix A:

## GPS Data Collection

### 1.0-Purpose

To develop consistent and accurate collection of Global Positioning System (GPS) data coordinates to determine the location of proposed Routine Roadway and Railway project activities.

GPS position accuracy can vary based on the type of GPS receiver used, field data collection techniques used, and post-collection processing of data.

### GPS Unit Requirements

The GPS unit must be capable of sub-meter accuracy for this application.

### 2.0 –Scope

This standard operating procedure applies to users of the BMP for Routine Roadway Maintenance Activities who are providing GPS coordinates at locations of proposed maintenance activities.

### 3.0 – Unit Settings

- Position mode – Manual 3D (do not allow 2D readings)
- Position averaging - Minimum # of positions = 18 (for a point-assuming a reading every 5 seconds for 90 seconds)
- Signal to noise ratio (SNR) – 6.0\*
- PDOP mask and switch – 6.0\*
- Elevation mask – 18 degrees

\*Note: These can be changed to slightly higher values (but keep less than 12) to get a difficult point but then should be changed back to the indicated levels before gathering the next one. The lower the value, the better the signal so increment it only to the extent to get a point. Make a note on the station form under the 'Locational comments' section what the settings were changed to so that the expected accuracy of the location can be modified.

### 4.0 – Obtaining Accurate Measurements

The GPS unit shall be capable of locating position to sub-meter accuracy. Follow directions for data collection according to the specific manufacturer's manual for the unit. Collecting data at a point location for a longer time and then averaging positions will yield better results. The GPS receiver should be initiated at the start of field visit, and data points should be collected as the last part of the field visit to allow for maximum position location. The GPS unit should be oriented skyward and positioned on the south side of the feature as available. GPS data points should be collected from a location having an unobstructed 'line of sight' skyward.

If a data point position is located under a heavy canopy or obstruction causing signal interference, then an off-set position should be determined. Measure the distance from the actual point location to the desired location. Record the distance, direction, and unit of measurement and under the GPS data location comments section.



## 5.0 – Waypoint Data

GPS data units should be presented as:

- Feet,
- Decimal Degrees,
- Degrees Minutes Seconds,
- or Degrees Decimal Minutes

GPS waypoint data measurements should include:

- 1) Location name, description
- 2) Data location waypoint coordinates (or with off-set)
- 3) Associated photo # on sketch

# Appendix B: Wetland Resource Identification

## B.1 Wetland Types

Wetlands are defined as areas inundated or saturated at a frequency and duration sufficient to support, and that under normal circumstances do support, a prevalence of vegetation typically adapted for life in saturated soil conditions. Wetlands generally include swamps, marshes, bogs and similar areas.



*Stirrup Brook wetland area, Salisbury, NH.*

*Credit: Kathryn Michener*

Wetlands tend to be located in depressions, at the toe of slopes, or in other areas where one might envision water collecting. Wetlands in New Hampshire are identified using a three-parameter approach:

- Hydrophytic (wetland) vegetation.
- Hydric soils.
- Wetland hydrology.

With the exception of heavily disturbed sites, all three parameters are required for an area to be considered a wetland.

If an area is heavily disturbed, all three parameters may not be present and

identification of all three would not be required for the area to be considered a wetland. Examples of this would be the complete removal of vegetation or grading of soils within the wetlands. Current practices of utility ROW Vegetation Management do not regularly fall within this guideline because the vegetation is only cut and most of the species re-generate from stump sprouts or existing root stock and can still be used in wetland identification.

## B.2 Forested Wetlands

Forested wetlands in New Hampshire are typically drier wetlands with standing water during large rain events ( $\frac{1}{2}$ -inch in 24 hours) and periods of high water (early spring through mid-summer). Red Maple and Hemlock are key identifiers of these wetlands.

These wetlands tend to have pit and mound topography and the trees appear to be standing up on their roots. These wetlands are also typically associated with flowing water contained in ephemeral (seasonal), intermittent and perennial streams and rivers. Forested wetlands may also contain vernal pools (see [B.6 – Vernal Pools](#)). Forested wetlands are considered the most common type in New England.

*Hulbert Swamp, Stewardstown, NH  
Credit: Amy Hudnor*



## B.3 Scrub-Shrub Wetlands



*Scrub-shrub cover on Ponemah Bog, Amherst, NH*

Scrub-shrub wetlands tend to be wetter than forested wetlands and may have standing water in places at all times except for the driest time of the year, *e.g.*, late summer. Scrub-shrub wetlands are a common feature in existing utility ROWs and are often maintained in this condition by the frequent trimming and removal of vegetation by utility providers. These wetlands often provide a variety of wildlife habitats for birds, mammals, amphibian and reptiles.

## B.4 Emergent Wetlands

Emergent wetlands, such as marshes and wet meadows, can vary by type, however, marshes lack woody vegetation.

### B.4.1 Marshes

Marshes are areas that are distinguished by the absence of trees and shrubs. Marshes are considered surface water as well as wetlands under state law. These areas are typically dominated by

soft-stemmed species such as grasses, cattails, sedges and rushes, and usually have a water table at or above the ground elevation for most of the year. Mucky soils in these wetlands may present access challenges for utility providers and often require the use of swamp mats in these areas. In the deeper marshes, access may not be possible due to water depths and soils.



*Marsh wetland in Washington, NH.*

*Credit: Sandy Crystall*



*Wetland monitoring in a wet meadow.*

*Credit: National Park Service*

### B.4.2 Wet Meadows

Wet meadows are areas dominated by non-woody species. These areas are typically saturated during the year but usually not flooded. These areas may exist due to frequent mowing to keep vegetation down. Wet meadow vegetation is varied and can include such common species as tussock sedge, rushes, grasses like blue joint and reed canary grass, and flowering herbaceous plants including Joe-Pyeweed, goldenrod, aster and many others. This wetland type is also commonly encountered in utility ROWs.

### B.4.3 Bogs

A bog is a non-tidal wetland that is distinguished by stunted evergreen trees and shrubs, peat deposits, poor drainage, and/or highly acidic soil and/or water conditions. Bogs lack any significant inflow or outflow of surface and groundwater throughout the year.



*Credit: Natural Heritage Bureau*

## B.5 Streams and their Banks

Jurisdictional areas under the wetlands dredge and fill law include streams and their banks. Streams in New Hampshire are defined by NHDES, in accordance with [Env-Wt 100 and Wt 900](#). (See the rules for appropriate methods and times for crossing streams).

Because work takes place year round, it is more important to have guidelines based on the methods appropriate for crossing (see [Chapter 2.8 – Stream Crossings](#)).

Disturbance of soil or work near flowing waters can cause water quality problems and violations, therefore particular attention should be given when planning work in these areas.



## B.6 Vernal Pools



Vernal pools are those wetlands and temporary ponds that typically have ponded water only part of the year. Because the pool is temporary, and contains no stream, they provide critical habitat for certain wildlife to breed and complete their life cycle.

Many of the animals that breed in vernal pools live in the upland areas around the pool during the non-breeding season. When pools dry, wood frogs migrate to forested upland areas that are as much as 1,000 to more than 2,000 feet from their breeding pools. Mole salamanders will migrate to forested uplands that are 1,000 feet from their breeding pools.

Vernal pools are a resource protected from unregulated alteration under the NHDES Wetlands law and rules. The rules provide definitions of vernal pool, primary vernal pool indicators and secondary vernal pool indicators. (See the University of Maine's [Vernal Pools Indicator Species](#) identification cards and NHFG's [Vernal Pool Documentation Manual](#).)

Typically, a vernal pool:

- Forms in a shallow depression or basin.
- Holds water for at least 2 continuous months following spring ice-out.
- Cycles annually from flooded to dry conditions, although the hydroperiod, size, and shape of the pool might vary from year to year.

- Has no permanently flowing outlet.
- Lacks a viable fish population.
- Supports one or more primary vernal pool indicators, or three or more secondary vernal pool indicators.

## B.7 Wetland Buffers

Wetland buffers are vegetated areas adjacent to wetlands that provide important protections and enhancements to the wetlands. These areas can provide filters to treat polluted water from human sources, such as roads and lawns. They also provide an important wildlife habitat adjacent to wetland areas. When possible, the integrity of a wetland buffer should be maintained during utility ROW maintenance activities. Make sure all appropriate local approvals have been obtained from the affected municipalities, as needed, to work in buffers.



## B.8 Wetland Vegetation

Hydrophytes (plants adapted for life in water or saturated soils) are one of the criteria for identifying wetlands. The US Department of Interior – Fish and Wildlife Service has published the [National List of Plant Species that Occur in Wetlands – Northeast Region](#), which is a list that ranks plant species according to their frequency of occurrence within wetlands. These classifications are

as follows:

- **Obligate (OBL):** Almost always (approximately 99%) occurs in wetlands.
- **Facultative Wet (FACW):** Usually (approximately 67-99%) occurs in wetlands, but occasionally occurs in non-wetlands.
- **Facultative (FAC):** Equally likely (approximately 34-66%) to occur in wetlands or non-wetlands.
- **Facultative Upland (FACU):** Usually (approximately 67-99%) occurs in non-wetlands but occasionally (approximately 1-33%) found in wetlands.
- **Upland (UPL):** Almost always (approximately 99%) occurs in non-wetlands.

Wetlands must have more than 50% OBL, FACW, or FAC plant species, unless there are plants that have adapted to living in wetlands by growing shallow roots, etc.

Obligate (OBL) Wetland Plants  
99% of time found in wetlands

Tree	Shrub	Herbs/Emergents
<ul style="list-style-type: none"> <li>■ Atlantic White Cedar (<i>Chamaecyparis thyoides</i>)</li> <li>■ Black willow (<i>Salix nigra</i>)</li> <li>■ Buttonbush (<i>Cephalanthus occidentalis</i>)</li> </ul>	<ul style="list-style-type: none"> <li>■ Buttonbush (<i>Cephalanthus occidentalis</i>)</li> <li>■ Leatherleaf (<i>Chamaedaphne calyculata</i>)</li> <li>■ Sweet gale (<i>Myrica gale</i>)</li> <li>■ Swamp loosestrife (<i>Decadon verticillatus</i>)</li> <li>■ Cranberry (<i>Vaccinium corymbosum</i>)</li> </ul>	<ul style="list-style-type: none"> <li>■ Blue Flag Iris (<i>Iris versicolor</i>)</li> <li>■ Bluejoint (<i>Calamagrostic canadensis</i>)</li> <li>■ Bulrush (<i>Scirpus</i> sp.)</li> <li>■ Canadian rush (<i>Juncus canadensis</i>)</li> <li>■ Common Cattail (<i>Typha latifolia</i>)</li> <li>■ Common rush (<i>Juncus effusus</i>)</li> <li>■ Common spike rush (<i>Eleocharis palustris</i>)</li> <li>■ Fringed sedge (<i>Carex crinata</i>)</li> <li>■ Pickerelweed (<i>Pontedaria cordata</i>)</li> <li>■ Rice cut grass (<i>Leersia oryzoides</i>)</li> <li>■ Royal Fern (<i>Osmunda regalis</i>)</li> <li>■ Sallow sedge (<i>Carex lurida</i>)</li> <li>■ Skunk Cabbage (<i>Symplocarpus foetidus</i>)</li> <li>■ Swamp Smartweed (<i>Polygonum hydropiperoides</i>)</li> <li>■ Tussock Sedge (<i>Carex stricta</i>)</li> </ul>

Facultative Wet (FACW) and Facultative (FAC) Plants  
67%-99% and 34-66% of time found in wetlands, respectively

Trees	Shrubs	Herbs/Emergents
<ul style="list-style-type: none"> <li>■ American Elm (<i>Ulmus americana</i>)</li> <li>■ Gray Birch (<i>Betula populifolia</i>)</li> <li>■ Red Maple (<i>Acer rubrum</i>)</li> <li>■ Silver maple (<i>Acer saccharinum</i>)</li> <li>■ Yellow Birch (<i>Betula alleghaniensis</i>)</li> </ul>	<ul style="list-style-type: none"> <li>■ Highbush Blueberry (<i>Vaccinium corymbosum</i>)</li> <li>■ Meadowsweet (<i>Spiraea alba</i> var. <i>latifolia</i>)</li> <li>■ Northern Arrow-wood (<i>Viburnum dentatum</i>)</li> <li>■ Silky Dogwood (<i>Cornus amomum</i>)</li> <li>■ Speckled Alder (<i>Alnus incana</i> spp. <i>rugosa</i>)</li> <li>■ Steeplebush (<i>Spiraea tomentosa</i>)</li> <li>■ Winterberry (<i>Ilex verticillata</i>)</li> </ul>	<ul style="list-style-type: none"> <li>■ Cinnamon Fern (<i>Osmunda cinnamomea</i>)</li> <li>■ Common Reed (<i>Phragmites australis</i>)*</li> <li>■ New England Aster (<i>Symphotrichum novae-angliae</i>)</li> <li>■ Purple Loosestrife (<i>Lythrum salicaria</i>)*</li> <li>■ Reed Canary Grass (<i>Phalaris arundinacea</i>)*</li> <li>■ Sensitive Fern (<i>Onoclea sensibilis</i>)</li> <li>■ Woolgrass (<i>Scirpus cyperinus</i>)</li> </ul>

Upland (UPL) Vegetation  
1% of the time found in wetlands

Trees	Shrubs	Herbs
<ul style="list-style-type: none"> <li>■ American Beech (<i>Fagus grandifolia</i>)</li> <li>■ Red Oak (<i>Quercus rubra</i>)</li> <li>■ Sugar Maple (<i>Acer saccharinum</i>)</li> <li>■ White Pine (<i>Pinus strobus</i>)</li> </ul>	<ul style="list-style-type: none"> <li>■ Huckleberry (<i>Gaylussacia baccata</i>)</li> <li>■ Maple-Leaved Viburnum (<i>Viburnum acerifolium</i>)</li> <li>■ Striped Maple (<i>Acer pensylvanicum</i>)</li> </ul>	<ul style="list-style-type: none"> <li>■ Bracken Fern (<i>Pteridium aquilinum</i>)</li> <li>■ Partridgeberry (<i>Mitchella repens</i>)</li> <li>■ Tree Clubmoss (<i>Lycopodium obscurum</i>)</li> </ul>

Names and wetland indicators from USDA Plants: <https://plants.usda.gov/>

## Common Plants Found in Different Wetlands in New Hampshire

### Trees



#### **Gray Birch (FAC) *Betula populifolia***

Gray birch is a wetland indicator tree that grows in either wetlands or uplands. This small growing birch is a pioneer species typically found on disturbed sites. It has dirty white bark as it grows older and never reaches taller than 20-25 feet. Even when old, the trees are often weak and it is not uncommon to see them bent over from damage caused by ice storms.



#### **Red Maple (FAC) *Acer rubrum***

Red maple is the most common New Hampshire wetland indicator species that grows in either wetland or upland areas. The stems have a red hue. The leaves are opposite with distinctive three lobes and very serrated edges. Red maples have red each season – red buds in the winter, red flowers in the spring, red stems in the summer and red leaves in the fall.

### Shrubs



#### **Elderberry (FACW) *Sambucus canadensis***

This facultative wetland shrub has soft, smooth gray-brownish bark with corky bumps and spongy white pith inside the twigs and branches. It flowers in early to mid-summer with clumps of white flowers at the ends of branches. It fruits in the summer and the berries persist to the fall.



#### **Highbush Blueberry (FACW) *Vaccinium corymbosum***

This is a common facultative wetland indicator shrub with characteristic summer blue berries that are a wildlife favorite. These multi-stemmed shrubs tend to grow to about eight feet and have scaly bark that sheds like shingles.



#### **Silky Dogwood (FACW) *Cornus amomum***

These facultative wetland indicator shrubs grow in thick clumps. Dogwood leaves have distinctive, parallel veins, reddish twigs and a dark brown pith. Compare with Redosier dogwood – another FAC Wet shrub with also with bright red stems. The two look similar but Silky has a brown pith (bluish fruit) and Redosier has white pith/fruit).





**Speckled Alder (FACW) *Alnus incana* (subsp. *rugosa*)**

Facultative wetland shrub that typically grows in wetlands. This shrub grows to 20 feet and has small brown catkins (seed pods) that persist through the winter. Its thin bark has pores or lenticels, that give it a speckled look, hence the common name. It often forms dense thickets around wetlands and streams.

**Herbs**



**Cattail (OBL) *Typha latifolia***

Obligate wetland plants that are readily identifiable with their long, flat blade-like leaves and familiar and distinctive brown sausage shaped flowering heads, topped with a small, sharp spike. Cattails are the classic characteristic indicator of wetlands – located on lakes, ponds and wetlands.



**Sensitive Fern (FACW) *Onoclea sensibilis***

Facultative wetland fern with a light green, wavy-edged distinctive leaf. Also known as “Bead fern,” as the fertile fronds or sori are clustered like brown beads and persist through the winter. A trail of sensitive bead fronds can help one find a snow-covered drainage.



**Sphagnum Moss**

There are 20 species of Sphagnum moss in New England (of 380 known species). Sphagnum is spongy and soft, can store water, and slowly spreads, forming blankets or mats across the water in what has become known as a “quaking bog.” It creates acidic conditions and slows anaerobic decay. This common moss is widespread in bogs, fens and many forested wetlands. Dried sphagnum is called “peat moss” and is used as a soil conditioner. For centuries and during World War I, sphagnum moss was used for dressing wounds because its absorptive, acidic quality inhibits growth of bacteria and fungi.



**Tussock Sedge (OBL) Carex stricta**

Obligate wetland herb. This common sedge species almost always grows in wetlands. It is characterized by growing in clumps and is usually surrounded by standing water for some period of time.

**Hydric Soils**

A hydric (wetland) soil is a soil that has developed under saturated conditions. The saturated conditions are lengthy enough to produce an anaerobic (lack of oxygen) environment within the soil. The saturation comes from the same water that drives the wetland development. Hydric soils are usually identified by some of the following characteristics:

- A very dark or thick topsoil layer.
- A high amount of organic matter in the topsoil. (Can be tested by squeezing a clump of soil. If the soil flows between the fingers, it is organic).
- Blotchy colors (mottles or redoximorphic features) at or near the surface.
- A gray-colored layer within 20 inches of the surface.



*Dark surface layer with redoximorphic features indicates possible wetland soil.*



*Left: Example of blotches indicating fluctuating (seasonal) water table.  
Right: Soil profile matrix with reduced (gray) orange blotches indicate fluctuating water table.*

## Wetland Hydrology

The wetland hydrology, the presence or absence of water, is the driving force behind any wetland. Without the presence of water for a minimum of two weeks during the growing season, the soils would not become anaerobic and the wetland vegetation would not be as strongly represented. Indications of hydrology are fairly easy to identify in the spring, when the water table is at its highest and most wetlands are ponded or saturated enough for water to be apparent. However, as spring turns into summer, the water table drops and it is necessary to focus on other indicators for confirmation that the area is a wetland. The following characteristics may be observed:

- Drainage patterns or scoured channels representing intermittent streams.
- Water- or silt-stained plant stems.
- Water-stained (gray or black in color) or silt covered leaves.
- Lines of organic debris, such as leaf litter, on tree and shrub stems above soil surface.
- Soils showing observable features of being saturated or flooded for long periods of time.
- Sphagnum moss on the surface.

## How to Identify Wetlands

Identifying wetlands is usually done by the USACE 1987 method; however, with appropriate background and training, areas that are wetlands or possible wetlands can be identified. The following guidelines will be used in determining if an area is a wetland:

**Does the area have standing water or stained leaves?** During most times of the year, if there is standing water, the area is most likely a wetland. It is important to note however, that in the spring, when water tables are at their highest, many areas that are not wetlands may have standing water. These areas are still of concern because of the high water table. Any excessive activity in these areas may cause rutting and soil disturbance that can lead to erosion and other issues. Note that many wetlands never have standing water.

**Is the area void of any woody plants?** Typically, areas that don't have woody plants, such as shrubs and trees, are classified as marsh and wet meadow wetlands. These areas also usually have standing water, except in the drier times of the year.

**Is there a defined channel?** A defined channel is one of the criteria that the NHDES uses to identify streams, whether they are perennial streams or small intermittent streams.

**Do plants typical to wetlands, dominate the area?** Knowing a few key species of plants will help in determining if an area is a possible wetland. Areas dominated by shrub species, such as speckled alder, willow, high bush blueberry and meadowsweet are typical of scrub-shrub wetlands. Also areas with tree species such as red maple or large fern species, such as cinnamon fern, are indicators of a forested wetland.

**Does the area look like it ponds water during wetter times of the year?** While working during dryer summer months, it may seem more difficult to determine if an area is a wetland but the ground will

provide clues. Areas with gray- or black-stained leaves on the ground mean that the area was ponded. Look for pit and mound micro-topography where trees and shrubs are growing on the mounds. Carefully investigate low lying areas where it looks like water would collect.

## Appendix D: Invasive Species Plant Identification

Those who will be working or operating equipment in areas that may contain invasive plant species should be trained in the identification and modes of dispersal and spread of common, highly prolific terrestrial invasive plant species that are commonly found along roadsides and in utility right-of-ways.

### Autumn Olive (*Elaeagnus umbellata*)

- **Description:** Woody, deciduous shrub growing up to 20 feet tall and 20 feet wide. Leaves are alternate, oval, glossy, grayish-green above and silvery below. Fragrant, tubular, whitish flowers in clusters of one to eight bloom from April to June. Bears sharp thorns as spur branches.
- **Habitat:** Common in open fields, roadsides, forest edges and other disturbed areas. Thrives in full sunlight and disturbed areas.
- **Reproduction:** Quarter-inch sized fruit that is silvery with brown scales when immature and speckled-red when mature. Fruits ripen September to October. Reproduces primarily by seed but can vegetatively sprout from stumps and roots.



### Common Reed (*Phragmites australis*)

- **Description:** Perennial grass growing up to 15 feet tall. Leaf blades flat, smooth, grayish-green, growing up to 20 inches long. Densely-branched flower clusters at the end of each stem that becomes open, feathery, and reddish at maturity. Can form large dense stands.
- **Habitat:** Found along roadsides and in wetland areas. Can grow in freshwater, brackish and saline marshes.
- **Reproduction:** Spreads primarily by an extensive aggressive system of horizontal and vertical rhizomes (roots) that can live for three to six years.



## Glossy Buckthorn (*Frangula alnus*)

- **Description:** Small deciduous tree or shrub growing up to 20 feet tall and 15 feet wide. Leaves are alternate, smooth-edged, oval, green and somewhat glossy, with dull green underside and 6-10 pairs of veins. Small greenish-yellow flowers in clusters of two to six. Re-sprouts vigorously and can form a dense thicket.
- **Habitat:** Can grow in both wetland and upland areas, open fields, and forest edges but prefers full sun.
- **Reproduction:** Pea-sized fruit with two to three seeds that ripen from green to red to black from July through September. Seeds are viable for several years and are primarily dispersed by birds. If cut, it can vegetatively sprout from the root crown and produce fruit on new shoots within the same season.



## Japanese Knotweed (*Polygonum cuspidatum*)

- **Description:** Perennial herbaceous shrub growing up to 10 feet tall. Soft, fleshy, green and red hollow, jointed stalks resembling bamboo. When stalks die, they dry and persist through the winter. Leaves are large, alternate, semi-triangular and green. Numerous small green to white flowers on a slender stalk bloom August through September. Forms dense thickets.
- **Habitat:** Found along roadsides, open spaces, stream and river banks, wetlands, wet depressions, and woodland edges. Can tolerate a wide array of soil and moisture conditions. Semi-shade tolerant.
- **Reproduction:** Primarily vegetatively through rhizomes. Even very small fragments of root material in soils can sprout to form new shoots.



## Oriental Bittersweet (*Celastrus orbiculatus*)

- **Description:** Woody, deciduous, twining vine that can climb to a height of 60 feet in trees and reach a diameter of four inches. Leaves are alternate, glossy, round and finely-toothed and turn yellow in the fall. Roots are a distinctive orange color. Small, greenish-yellow, five-petaled flowers cluster in the leaf axils and bloom May through June.
- **Habitat:** Found in grasslands, open woods, woodland edges, along roadsides, fence rows and stream and river banks. Extremely shade tolerant. Can climb and overtake trees and shrubs.
- **Reproduction:** Fruits are green in summer and turn yellow and orange in the fall. Fruits contain three to six seeds and can remain on the vine throughout winter. Reproduces by prolific seed production (primarily from birds) and spreading underground roots that form new stems.



## Purple Loosestrife (*Lythrum salicaria*)

- **Description:** Perennial herbaceous plant growing up to six feet tall. Its stem can become woody with age. Leaves are elongated and opposite or whorled, with lightly heart-shaped bases, producing numerous purple to magenta flowers on a terminal spike that bloom July through September. Flowers produce seed capsules with prolific seed production.
- **Habitat:** Found primarily in sunny, wet areas, such as wet meadows and marshes, but can also spread into uplands. Can tolerate a wide range of soil types but prefers organic soils.



In accordance with the Invasive Species Act, HB 1258-FN, the New Hampshire Department of Agriculture, Markets & Food, Division of Plant Industry, is the lead state agency responsible for the evaluation, publication, and development of rules on invasive plant species for the purpose of

protecting the health of native species, the environment, commercial agriculture, forest crop production, or human health. The rule, Agr 3800, states “No person shall conduct, transport, import, export, move, buy, sell, distribute, propagate, or transport any living and viable portion of any plant species, which includes all of their cultivars and varieties, listed in Table 3800.01, New Hampshire prohibited invasive species list.”

<b>Table D-1: New Hampshire Prohibited Invasive Plant Species List (Approved by the New Hampshire Invasive Species Committee on March 17, 2016)</b>	
■	Amur Honeysuckle ( <i>Lonicera maackii</i> )
■	Autumn Olive ( <i>Elaeagnus umbellata</i> )
■	Bella Honeysuckle ( <i>Lonicera x bella</i> Zabel)
■	Black Swallow-Wort ( <i>Cynachum nigrum</i> )
■	Blunt-Leaved Privet ( <i>Ligustrum obtusifolium</i> )
■	Bohemia Knotweed ( <i>Reynoutria x bohémica</i> )
■	Burning Bush ( <i>Euonymus alatus</i> )
■	Common Buckthorn ( <i>Rhamnus cathartica</i> )
■	Common Privet ( <i>Ligustrum vulgare</i> )
■	European Barberry ( <i>Berberis vulgaris</i> )
■	European Black Alder ( <i>Alnus glutinosa</i> )
■	Garlic Mustard ( <i>Alliaria petiolata</i> )
■	Giant Hogweed ( <i>Heracleum mantegazzianum</i> )
■	Giant Knotweed ( <i>Reynoutria sachalinensis</i> )
■	Glossy Buckthorn ( <i>Rhamnus frangula</i> / <i>Frangula alnus</i> )
■	Japanese Barberry ( <i>Berberis thunbergii</i> )
■	Japanese Honeysuckle ( <i>Lonicera japonica</i> )
■	Japanese Knotweed ( <i>Polygonum cuspidatum</i> / <i>Fallopia japonica</i> )
■	Japanese Silt Grass ( <i>Microstegium vimineum</i> )
■	Kudzu ( <i>Pueraria montana</i> )
■	Mile-A-Minute Weed ( <i>Polygonum perfoliatum</i> )
■	Moneywort ( <i>Microstegium vimineum</i> )
■	Morrow’s Honeysuckle ( <i>Lonicera morrowii</i> )
■	Multiflora Rose ( <i>Rosa multiflora</i> )
■	Norway Maple ( <i>Acer platanoides</i> )
■	Oriental Bittersweet ( <i>Celastrus orbiculatus</i> )
■	Ornamental Jewelweed ( <i>Impatiens glandulifera</i> )
■	Pale Swallow-Wort ( <i>Cynanchum rossicum</i> )
■	Perennial Pepperweed ( <i>Lepidium latifolium</i> )
■	Reed Sweet Grass ( <i>Glyceria maxima</i> )
■	Spotted Knapweed ( <i>Centaurea biebersteinii</i> )
■	Tartarian Honeysuckle ( <i>Lonicera tartarica</i> )
■	Tree of Heaven ( <i>Ailanthus altissima</i> )
■	Water Flag Iris ( <i>Iris pseudacorus</i> )

## **Appendix E: New Hampshire Designated Rivers Map**

For the most up-to-date information regarding Designated Rivers, visit the NHDES website at:

<http://des.nh.gov/organization/divisions/water/wmb/rivers/designriv.htm>

## **Appendix F: Prime Wetlands**

For most up to date list of Prime Wetlands visit the NHDES webpage:

[http://des.nh.gov/organization/divisions/water/wetlands/prime\\_wetlands.htm](http://des.nh.gov/organization/divisions/water/wetlands/prime_wetlands.htm)

## **Definitions**

Definitions are in accordance with official adopted rules in [Env-Wt 100](#).